

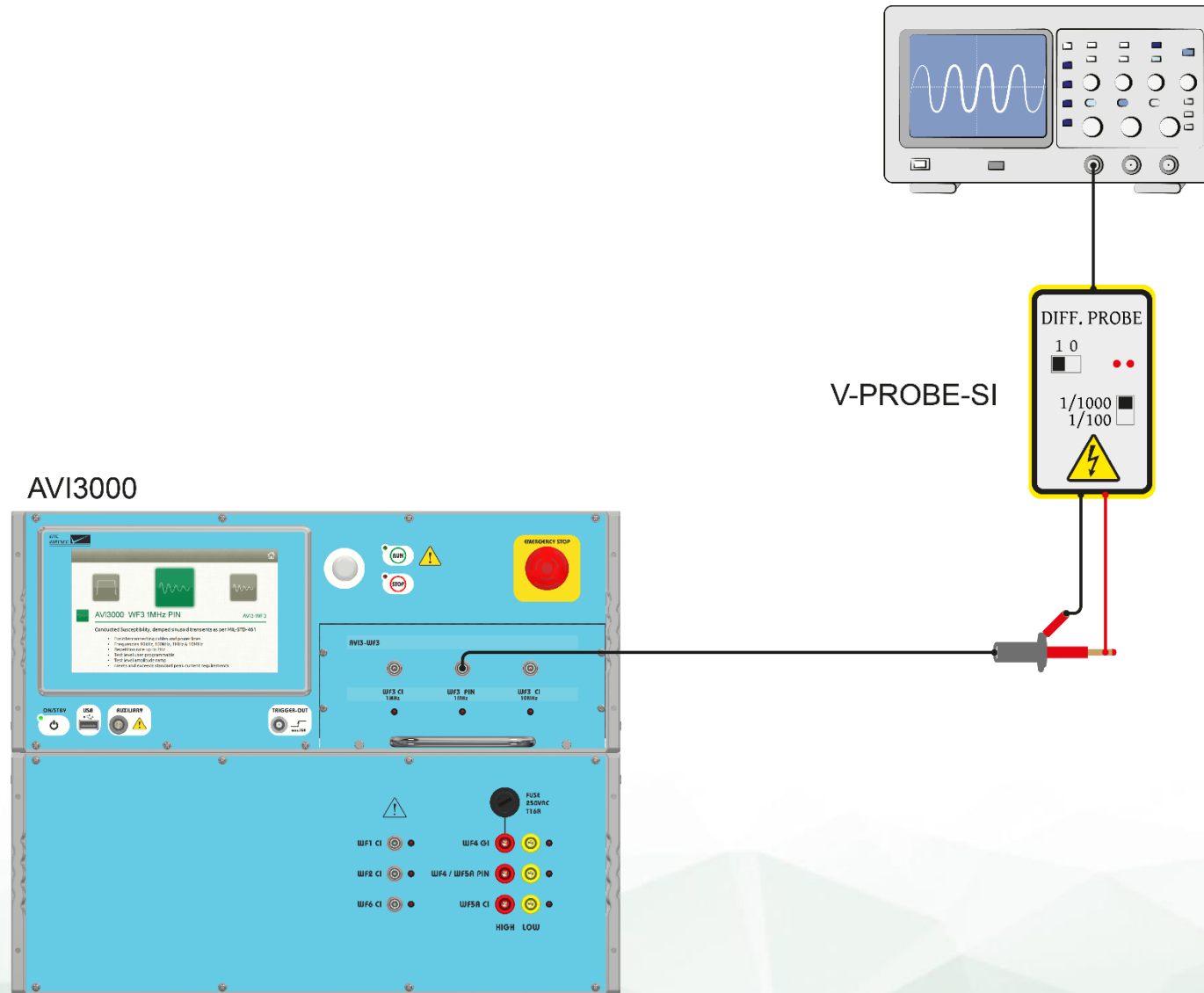

## AVI3000 - calibration and test setups

**A revolution in the field of indirect lightning tests**

- 
- ✓ Pin Injection (PIN):  
[WF 3 \(1 MHz\)](#), [WF 4](#), [WF 5A](#)
  - ✓ Cable Induction (CI):  
[WF 1](#), [WF 2](#), [WF 3 \(1 MHz\)](#), [WF 3 \(10 MHz\)](#), [WF 4](#), [WF 5A](#), [WF 6](#)
  - ✓ Ground Injection (GI):  
[WF 4](#), [WF 5A](#)



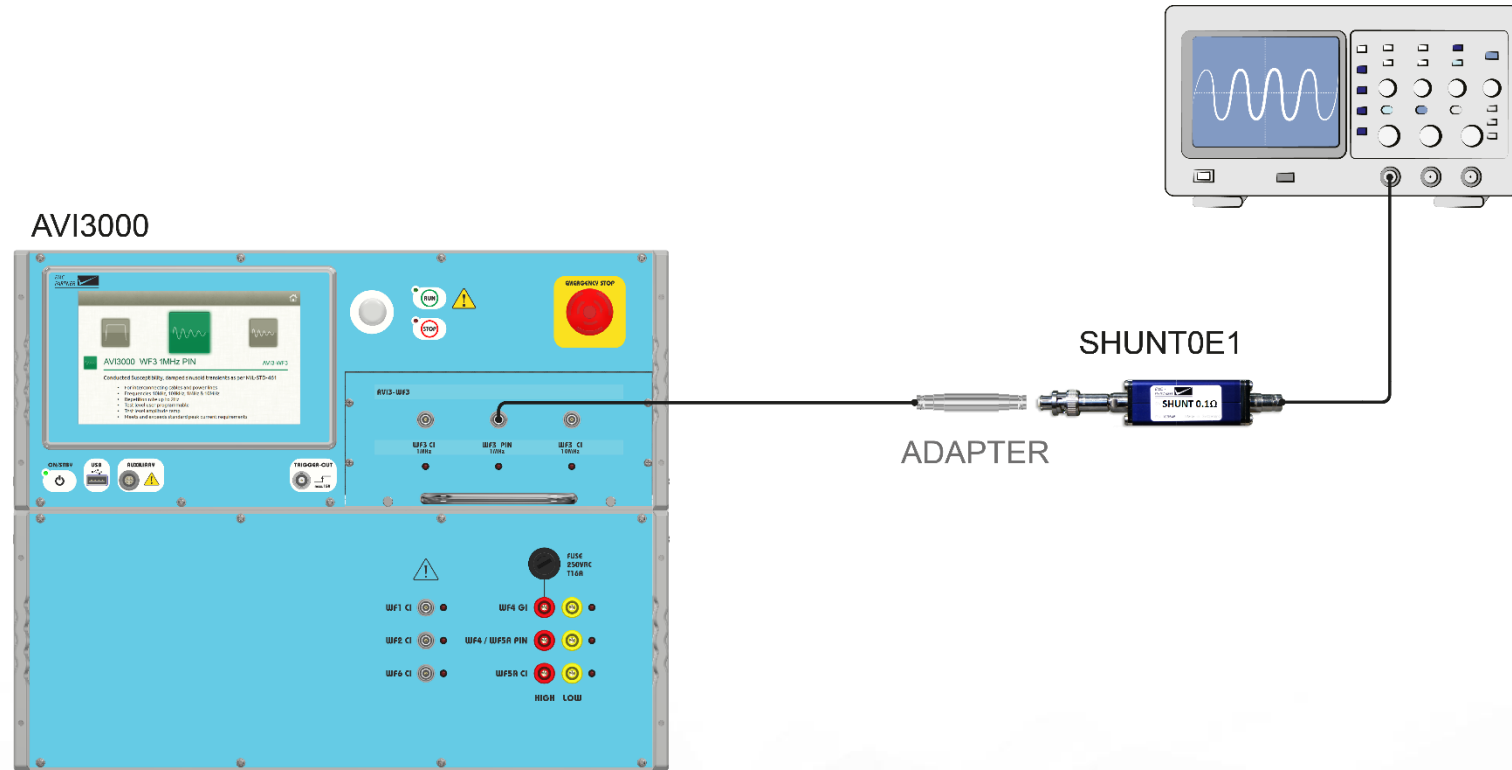

AVI3000

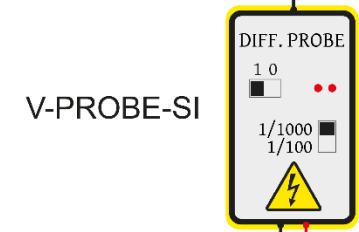
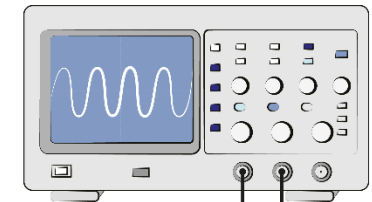
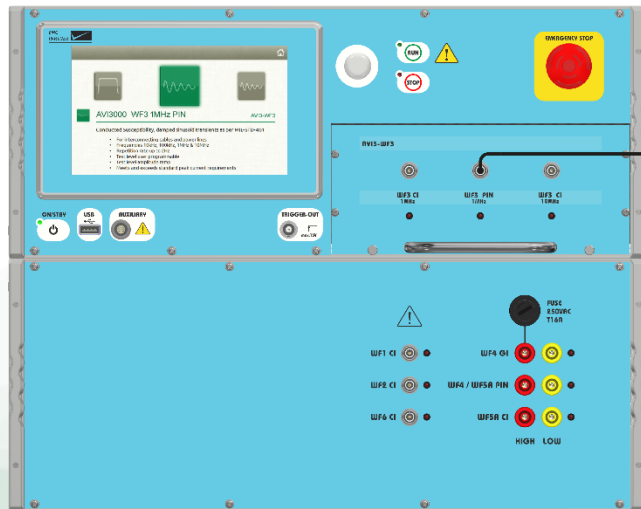

V-PROBE-SI

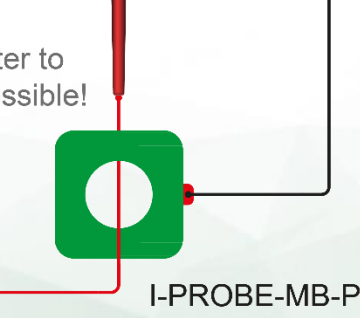
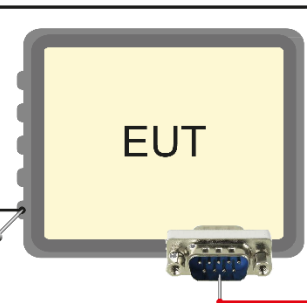

I-PROBE-MB-P1

Not to scale.  
Cables from adapter to tips as short as possible!

ADAPTER

### AVI3000

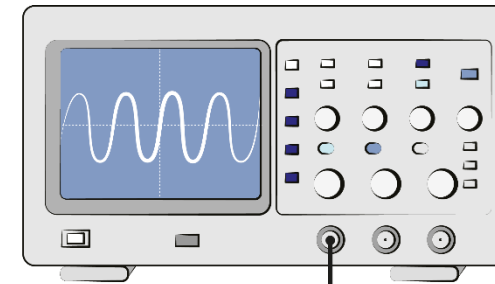
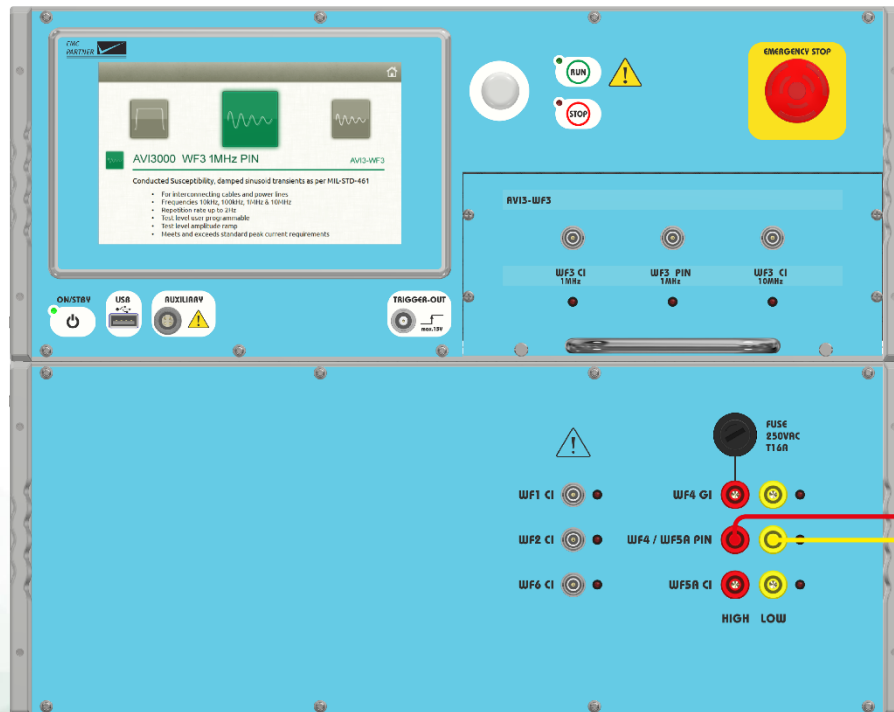

V-PROBE-SI

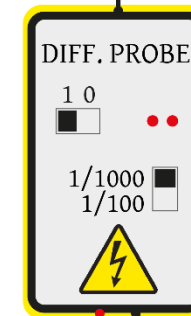

2 m cables

Attenuator 20 dB between probe and DSO

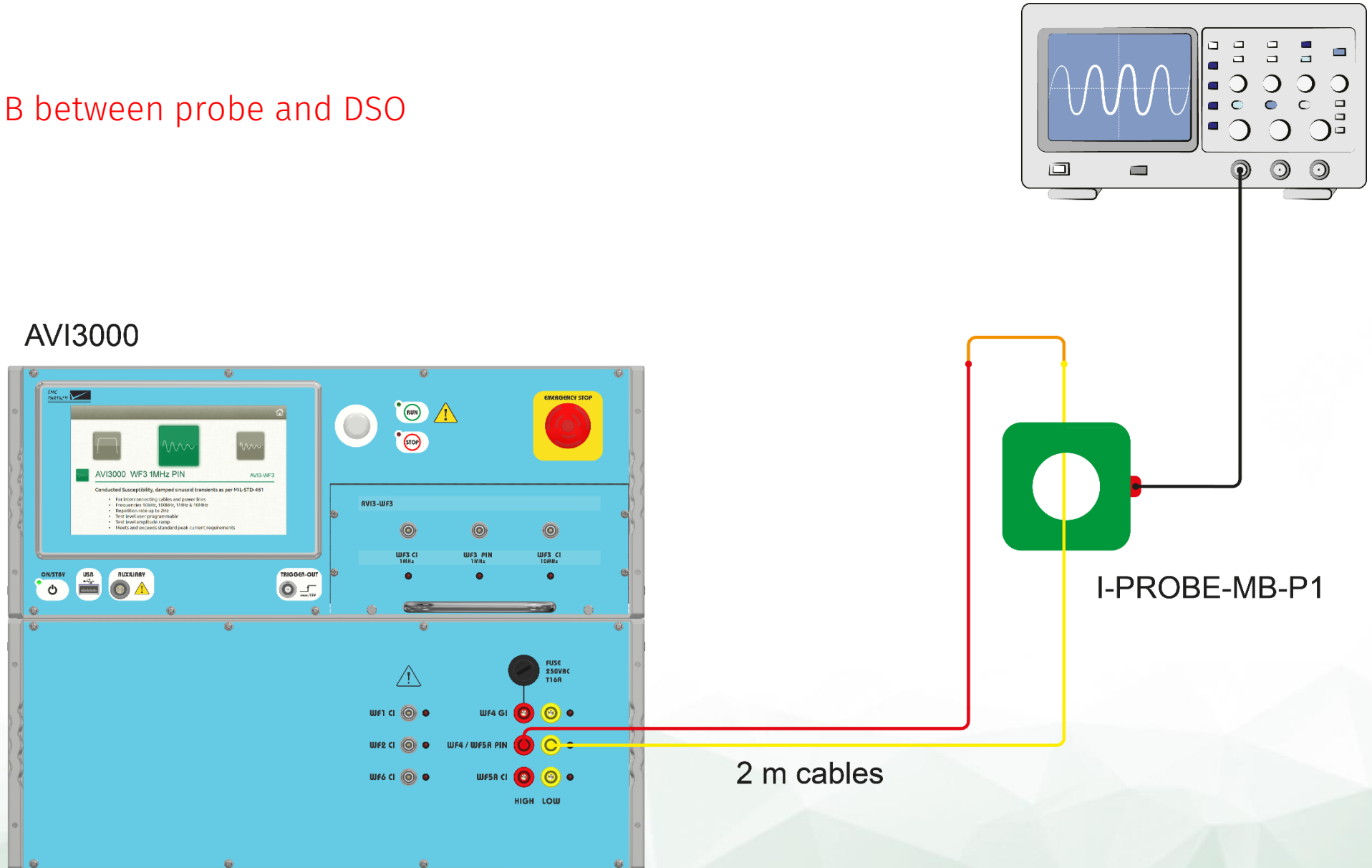

AVI3000

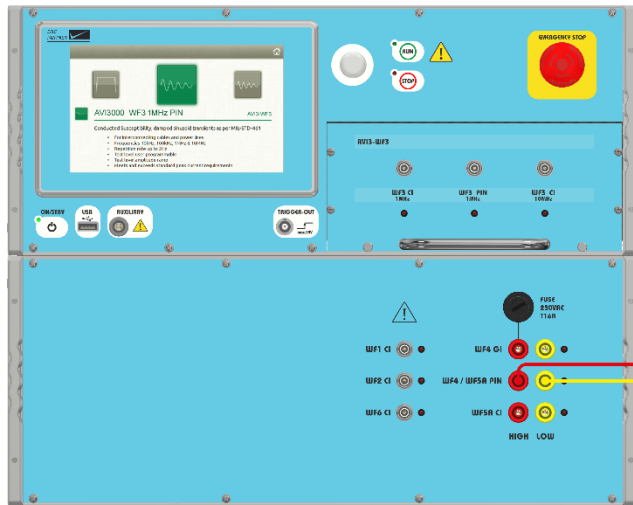

2 m cables

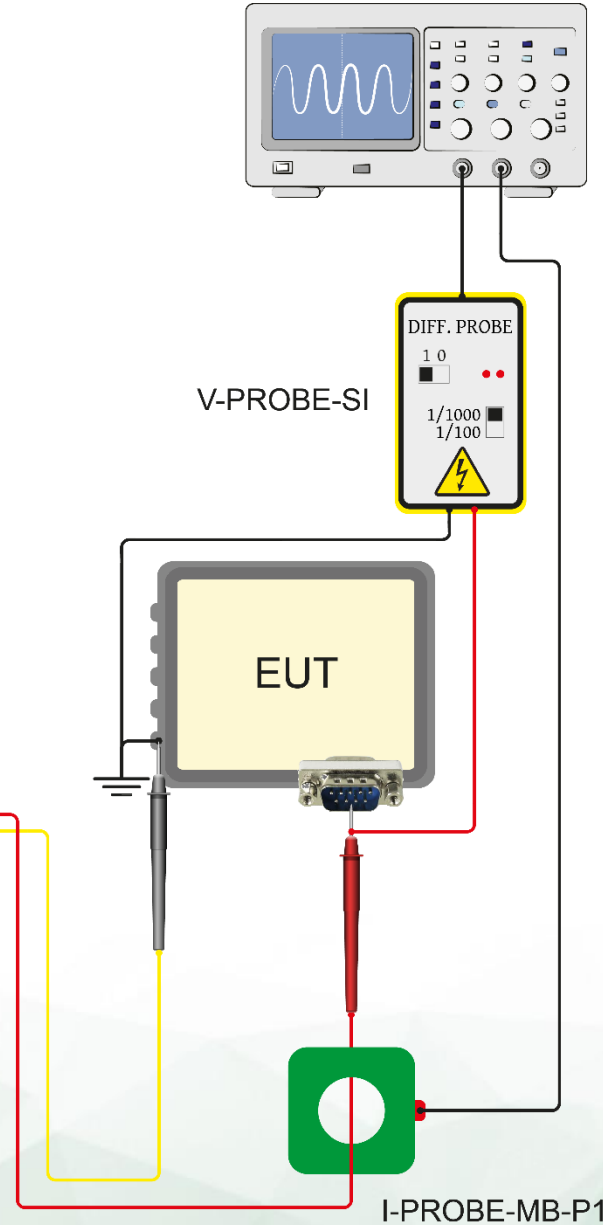



### AVI3000

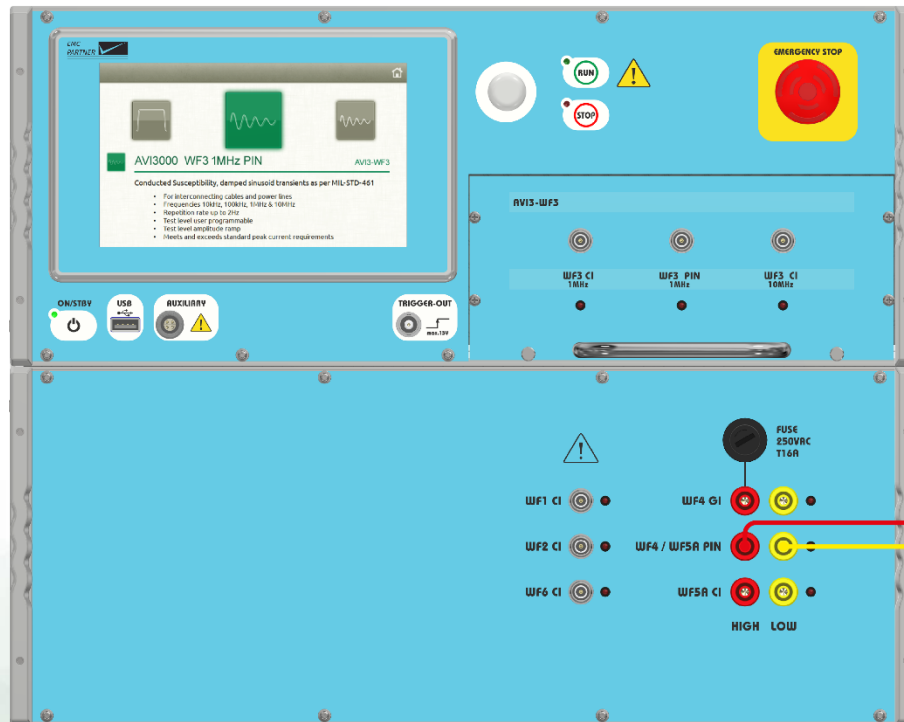

### V-PROBE-SI

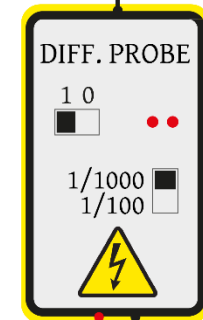
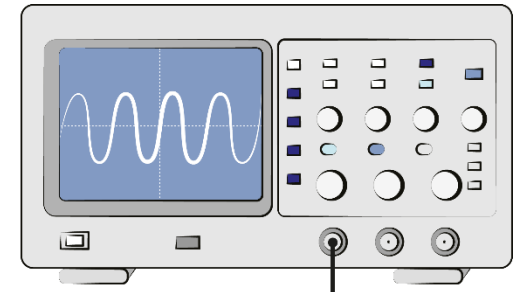

2 m cables

Attenuator 20 dB between probe and DSO

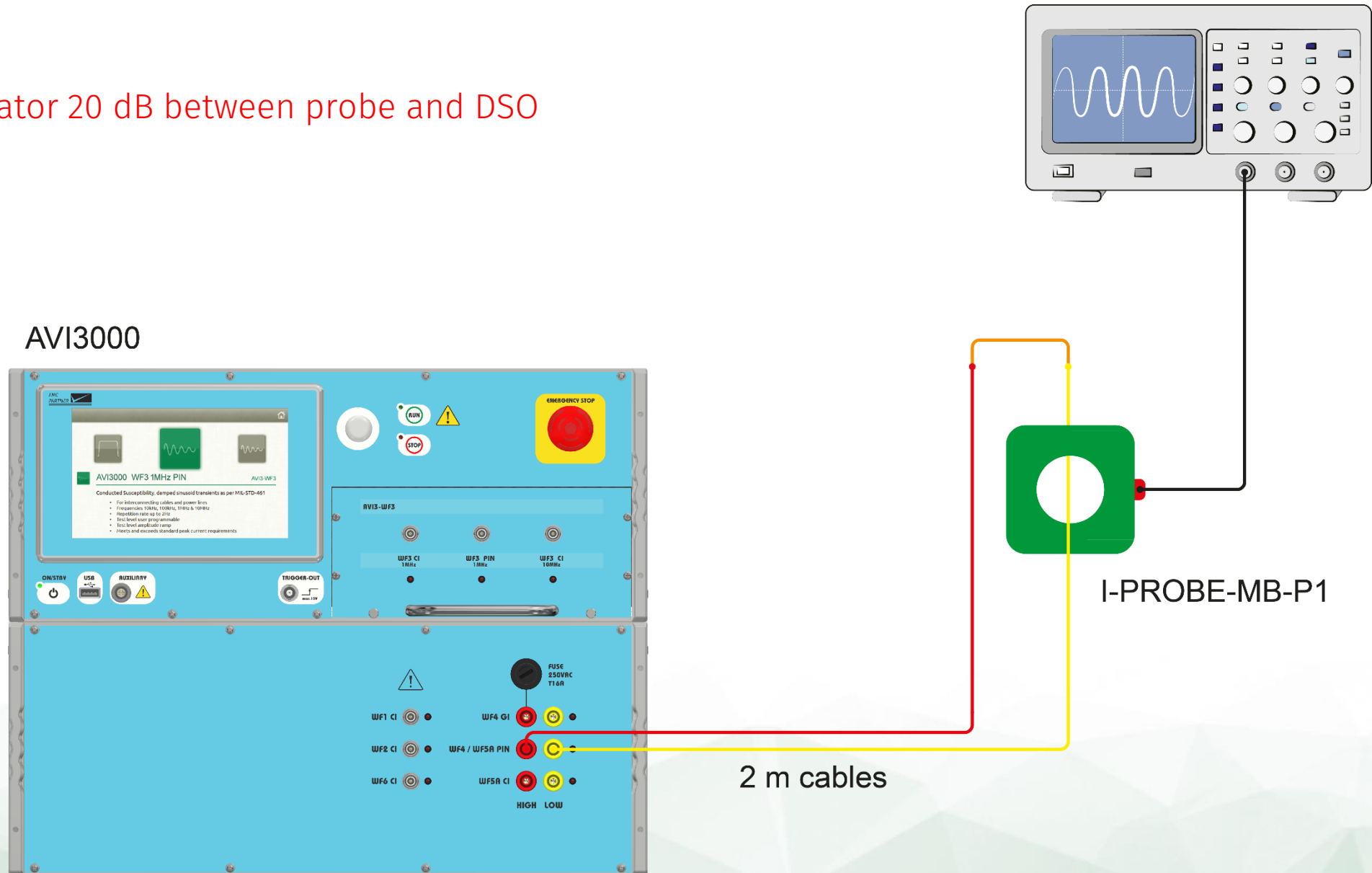

AVI3000

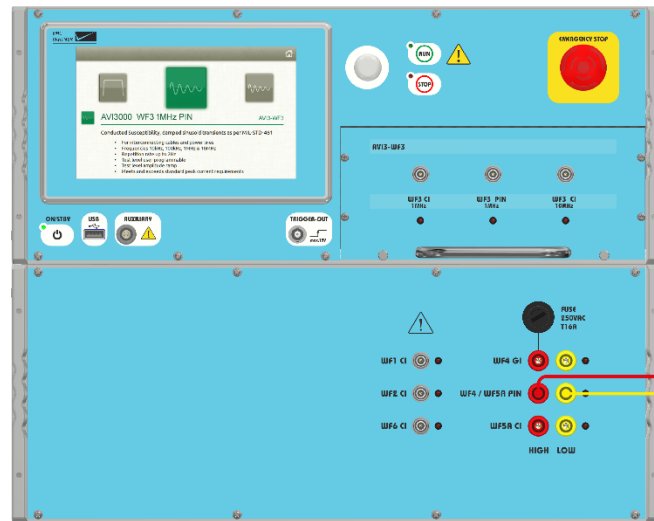

2 m cables

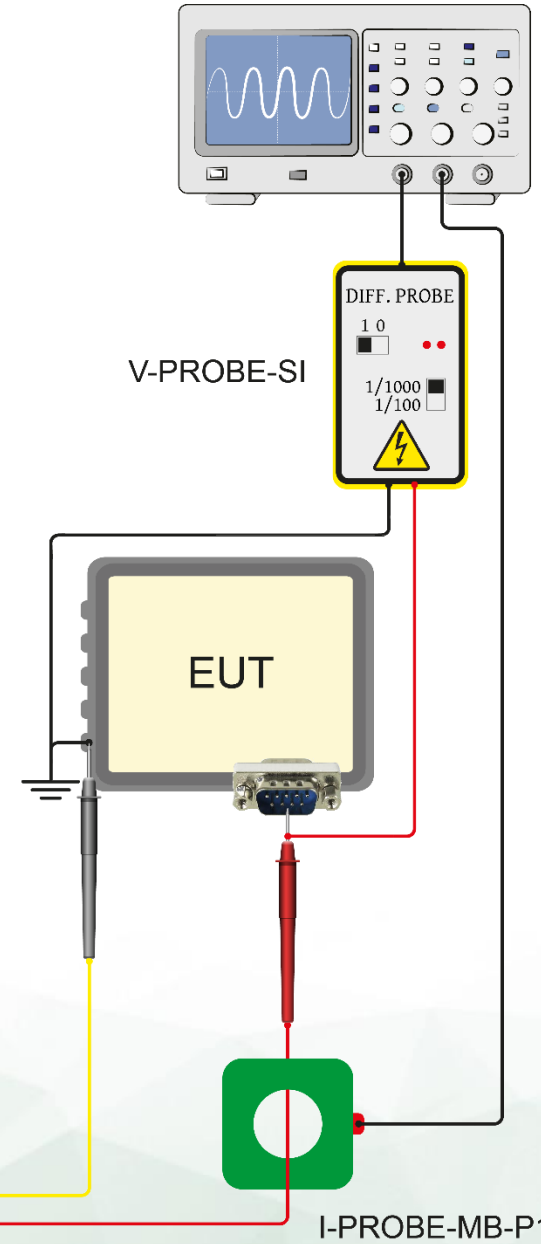

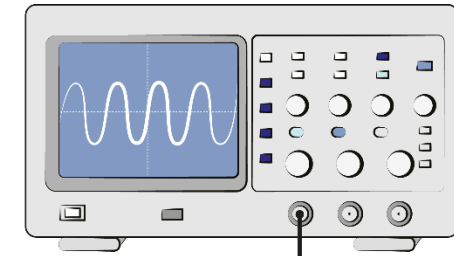

AVI3000

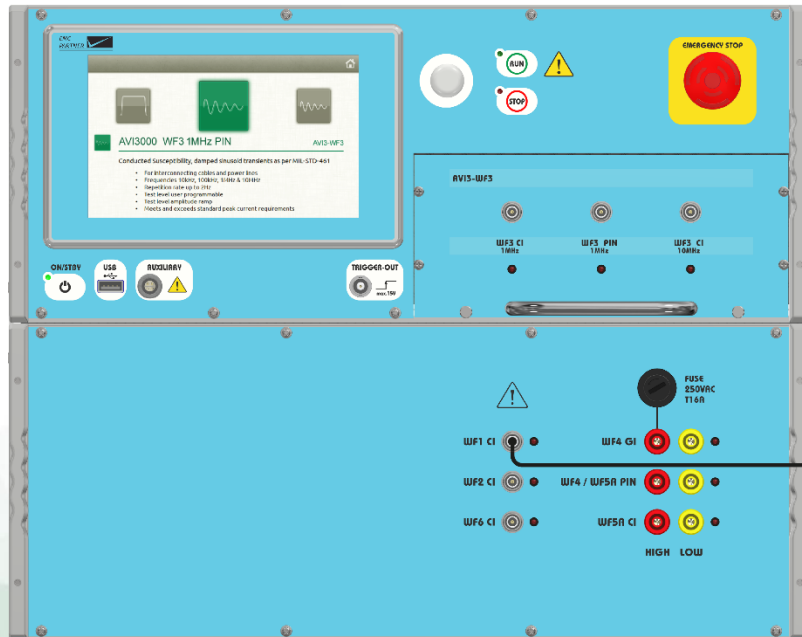

CN-BT7

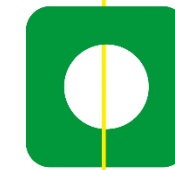
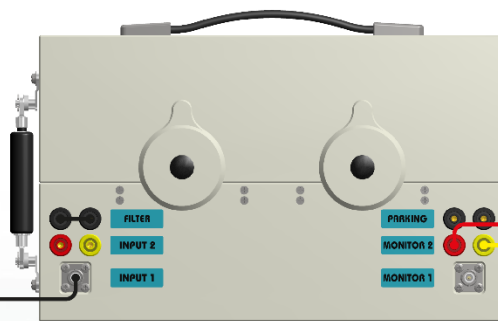

I-PROBE-MB-P1

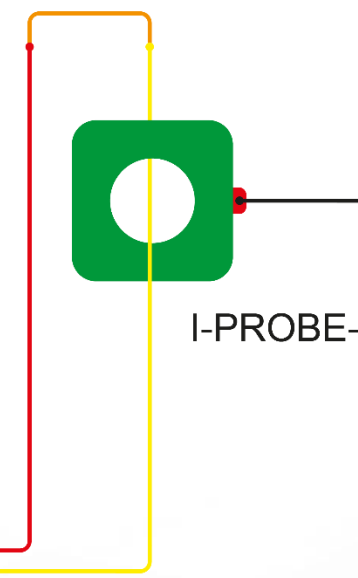

AVI3000

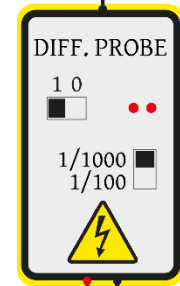
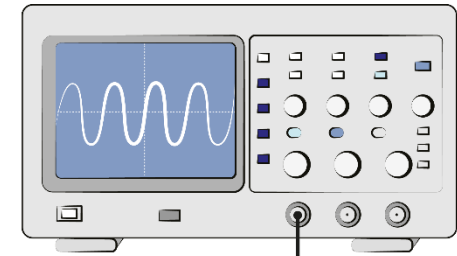
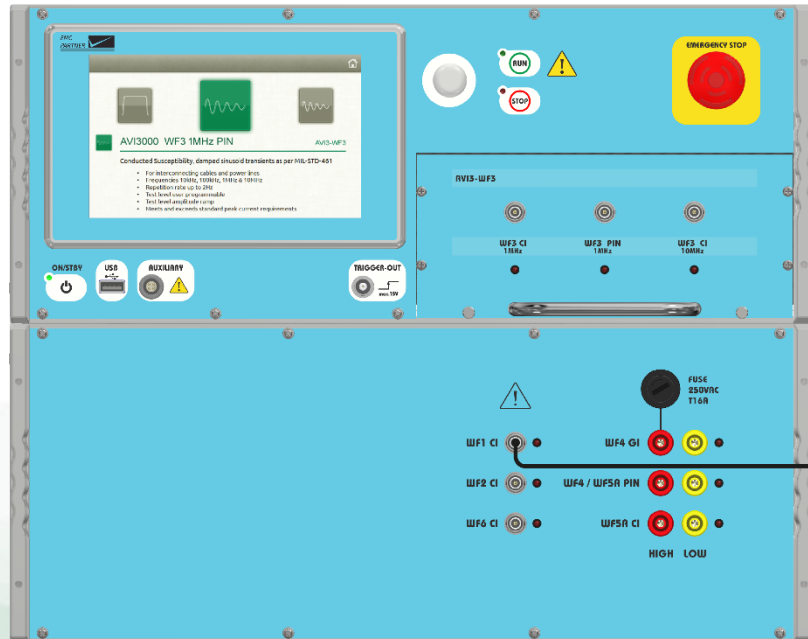

V-PROBE-SI

CN-BT7

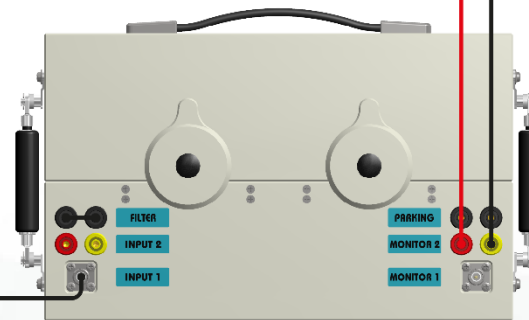

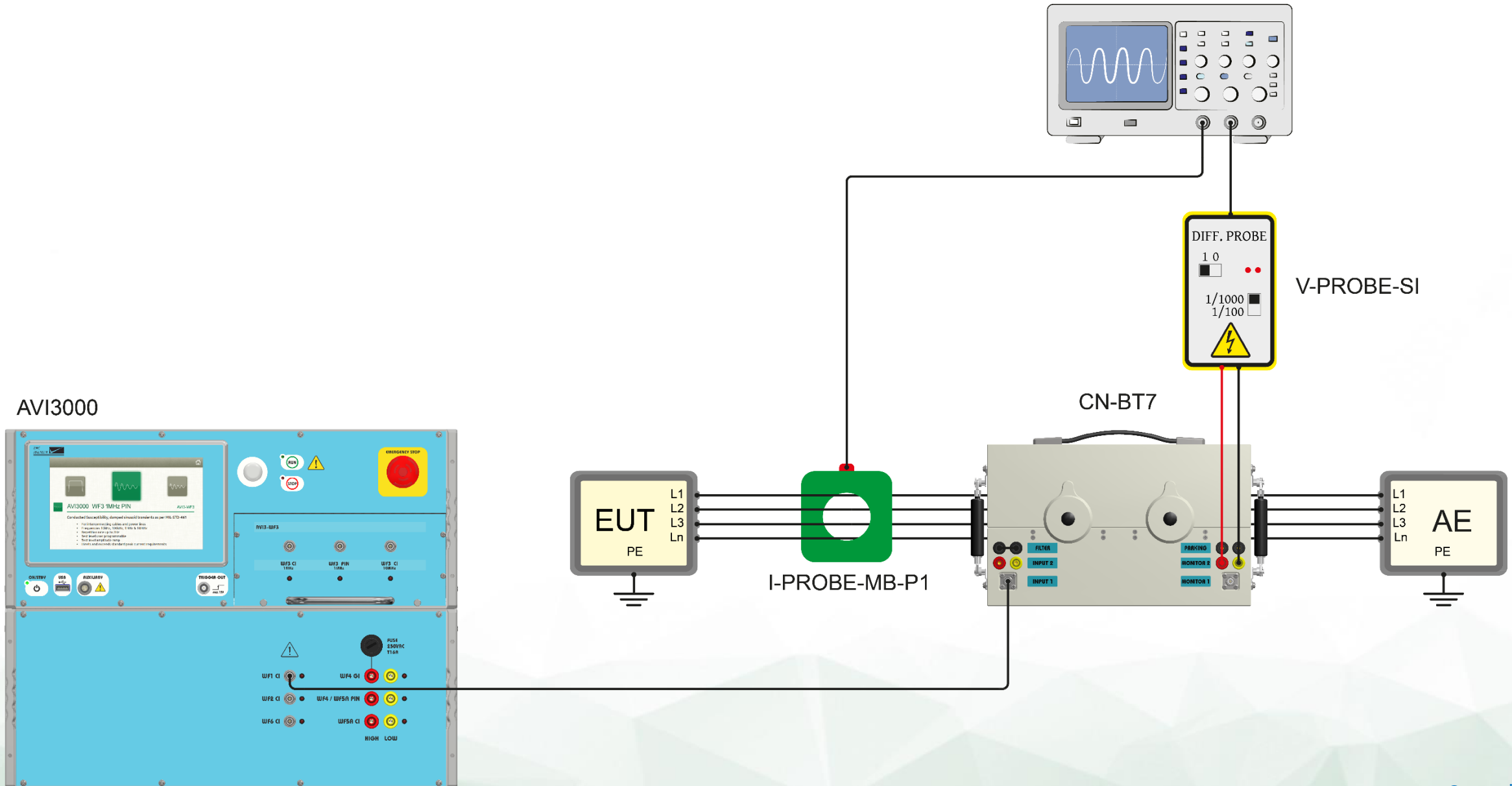

AVI3000

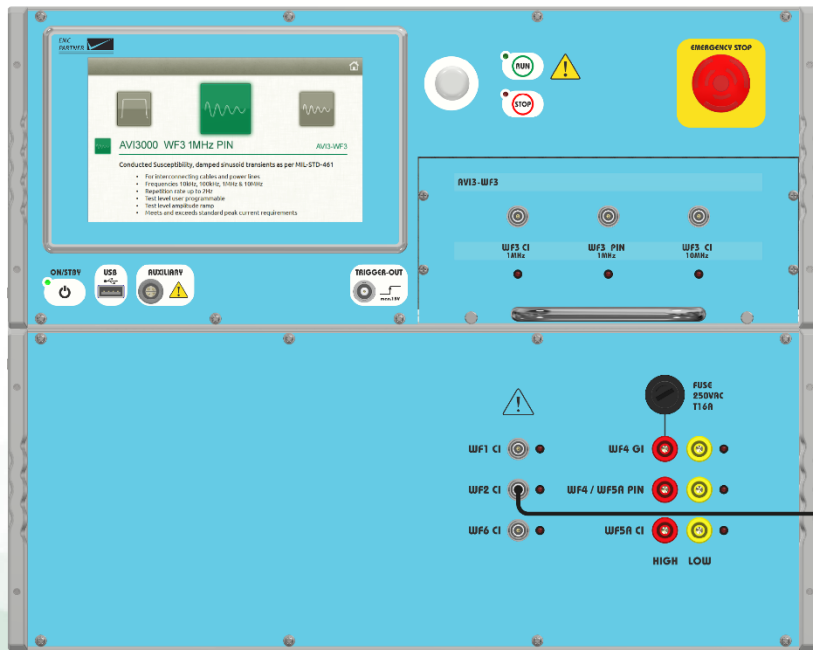

Filter WF2 in position INPUT 2

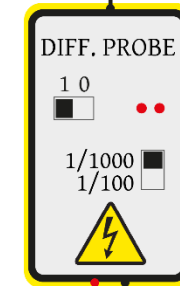
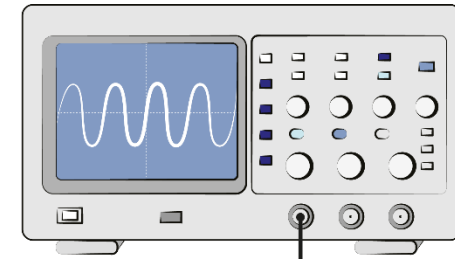

V-PROBE-SI

CN-BT7

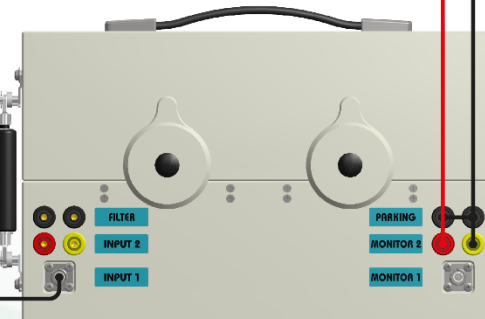

Bridge in PARKING position

## AVI3000

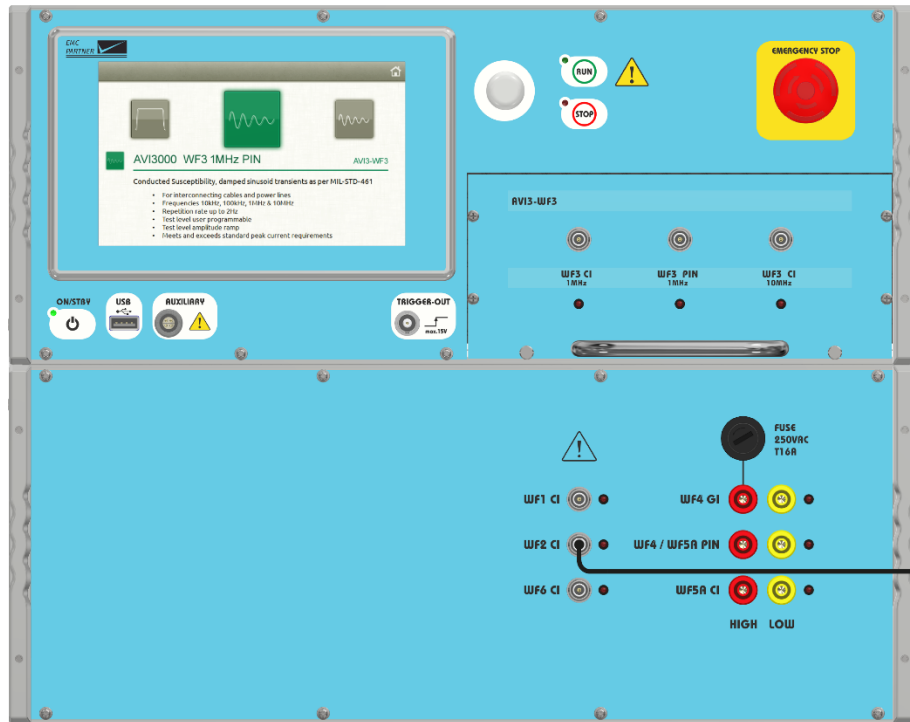

## CN-BT7

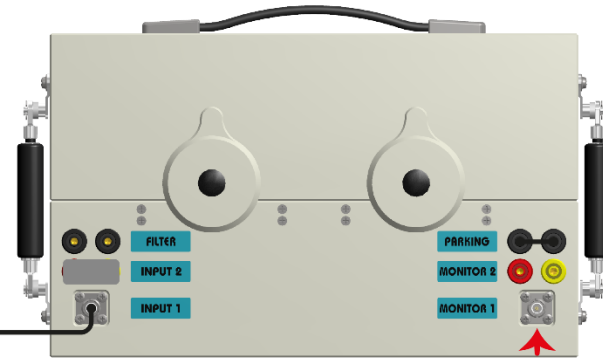

## SHUNT0E1

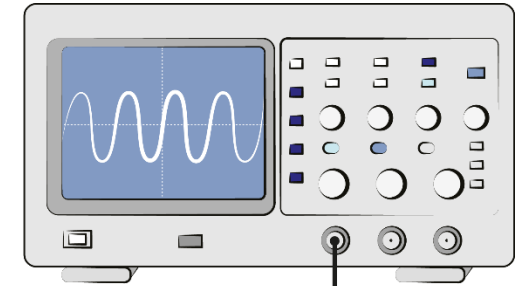



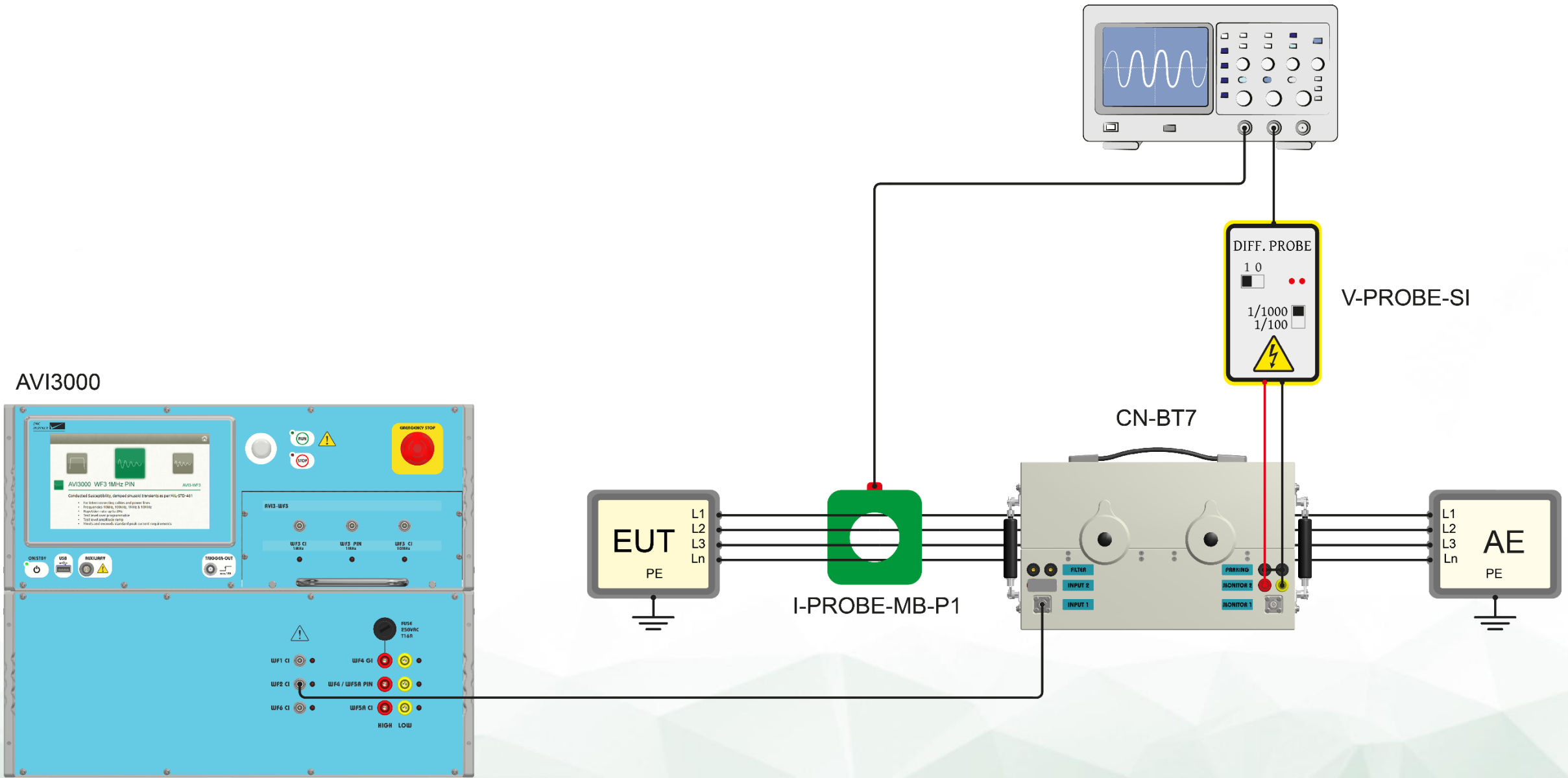

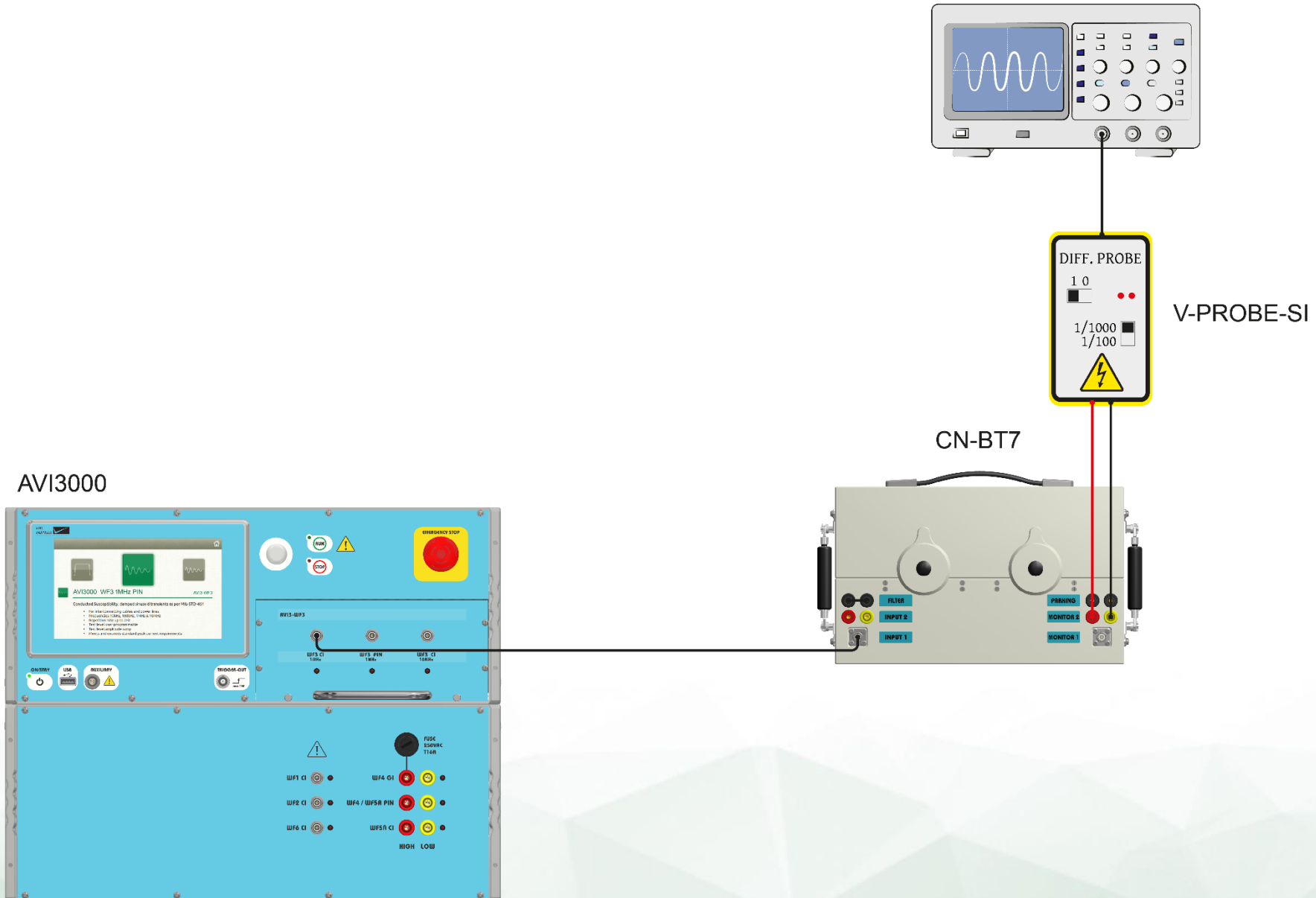

AVI3000

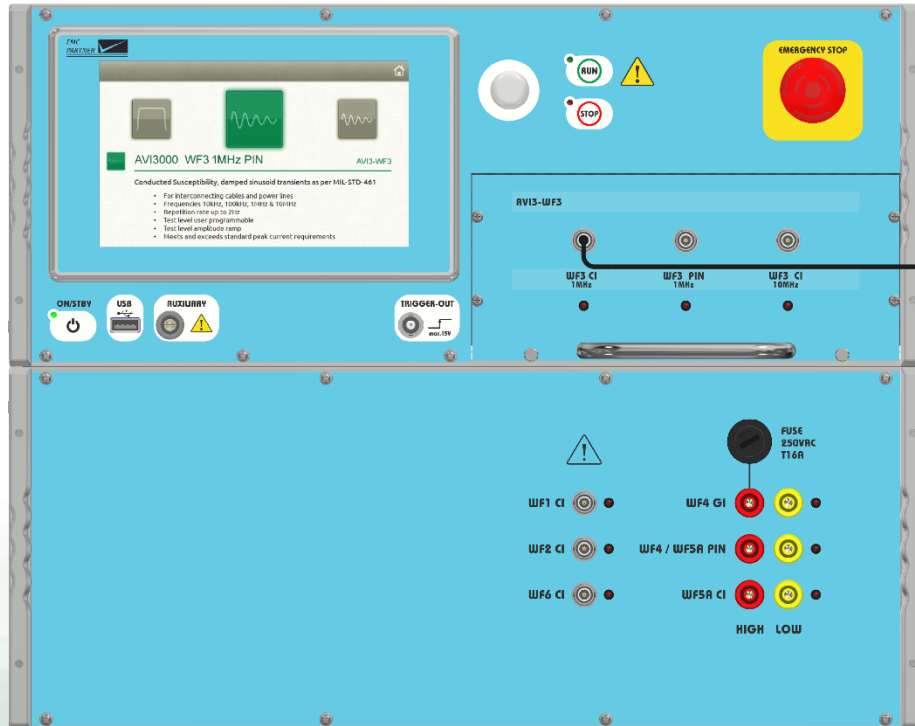

CN-BT7

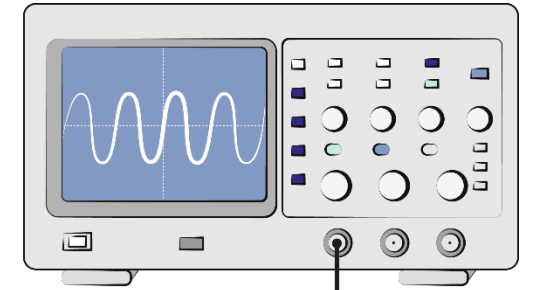
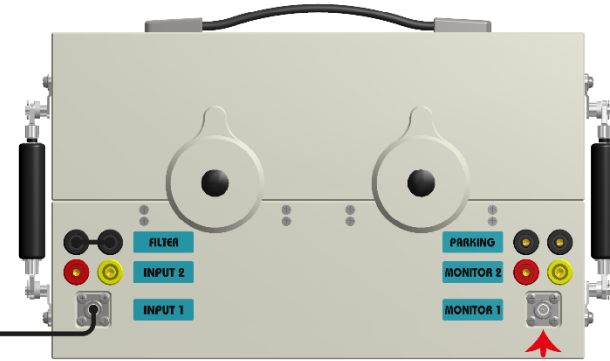

SHUNT0E1



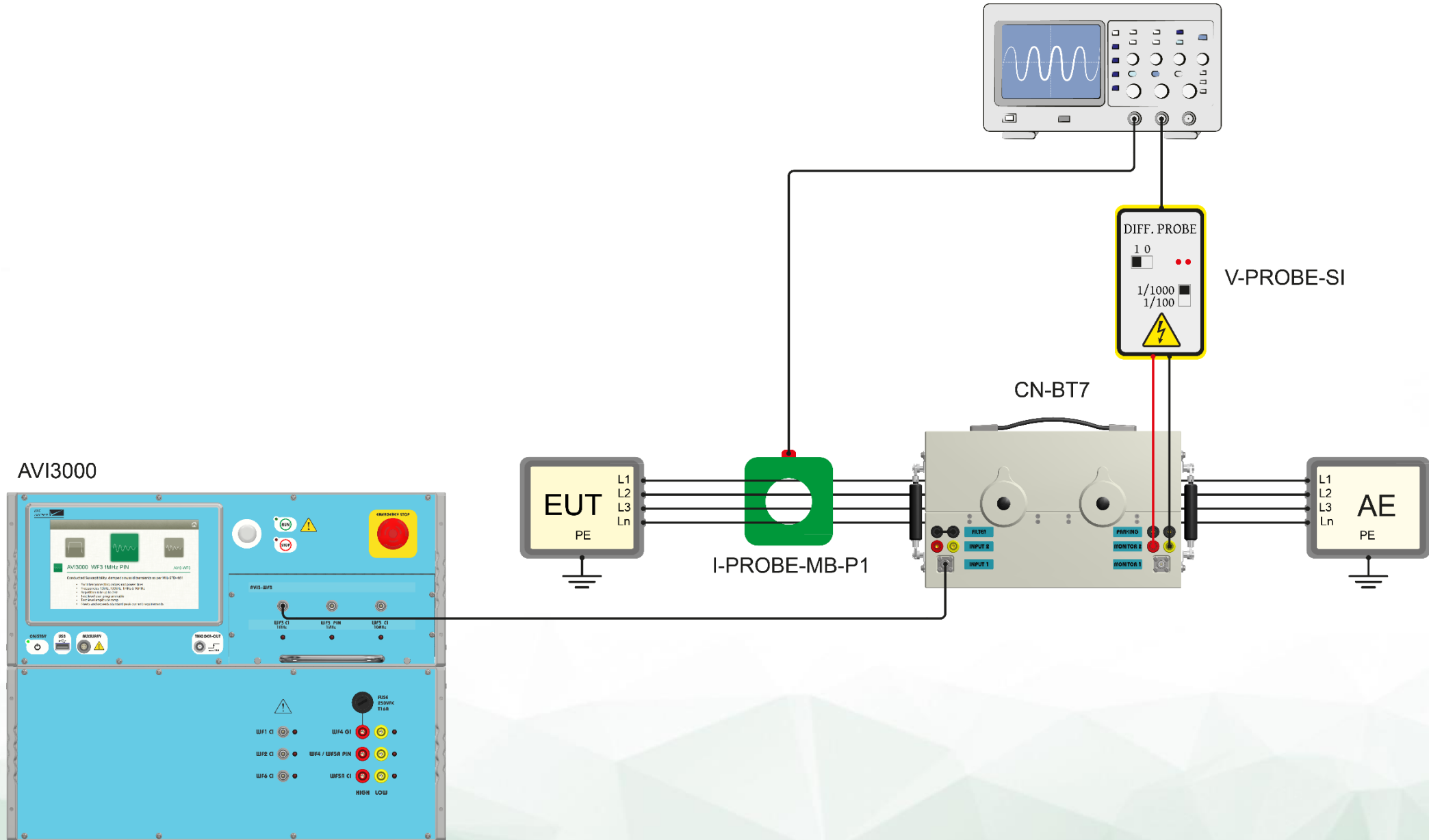

➔ Remove bridge from position FILTER  
and insert it in position PARKING (only for WF 3 10 MHz)

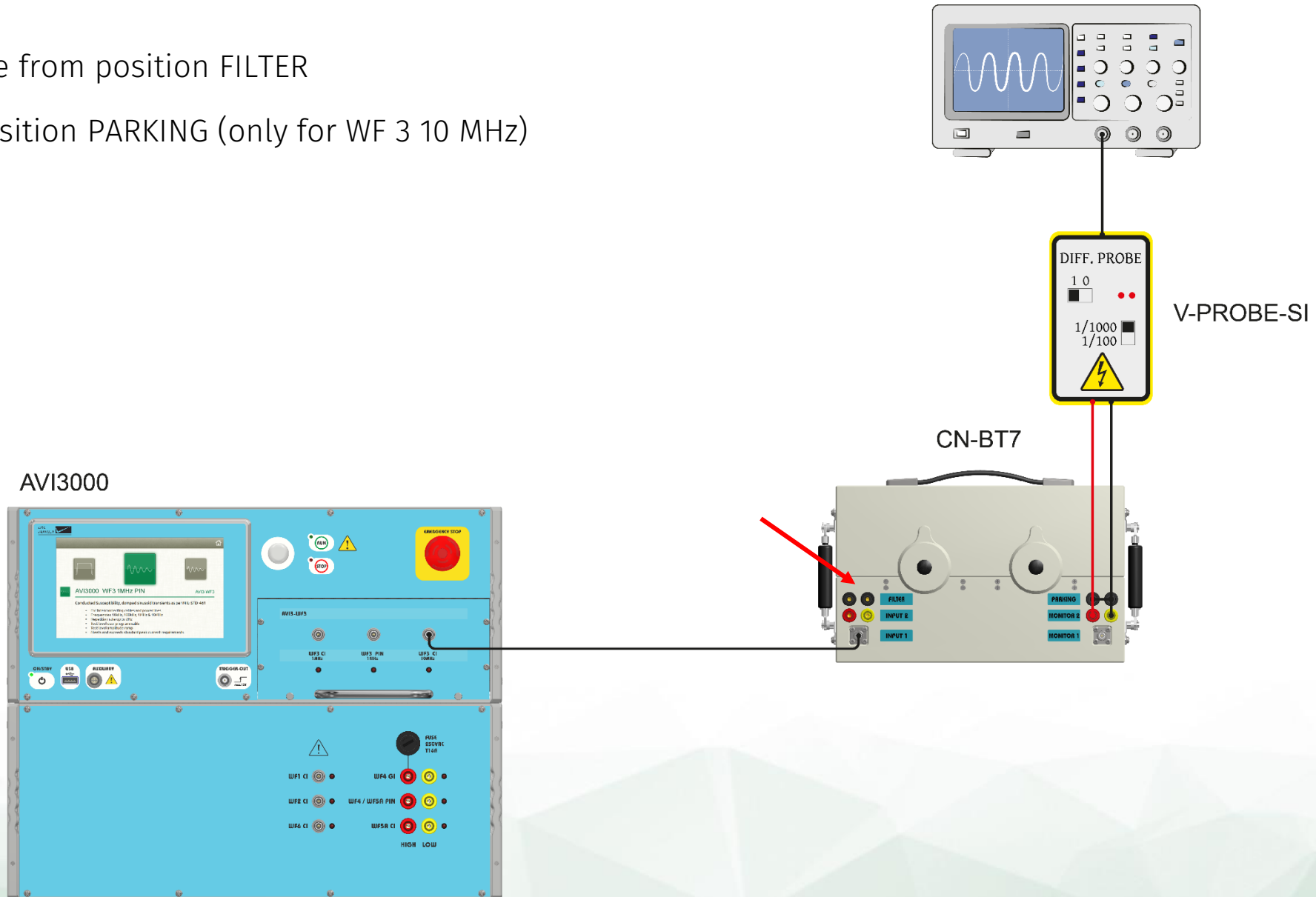

AVI3000

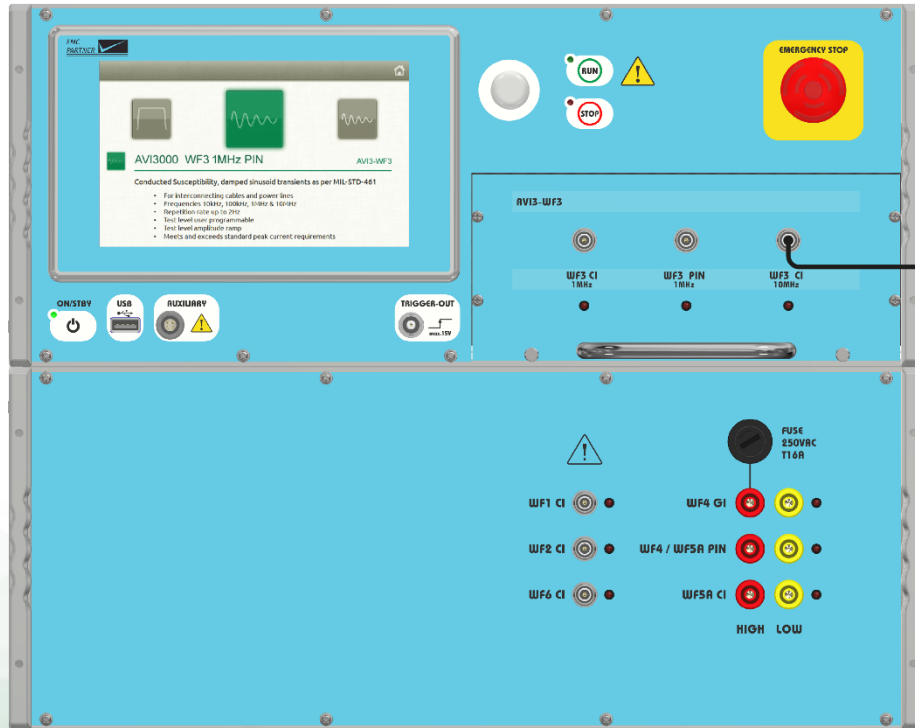

CN-BT7

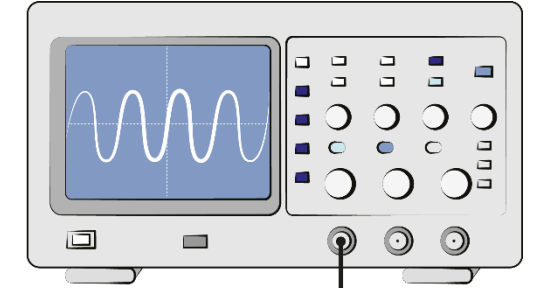
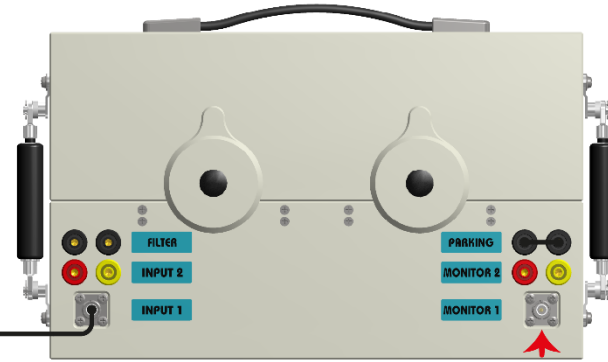

SHUNT0E1

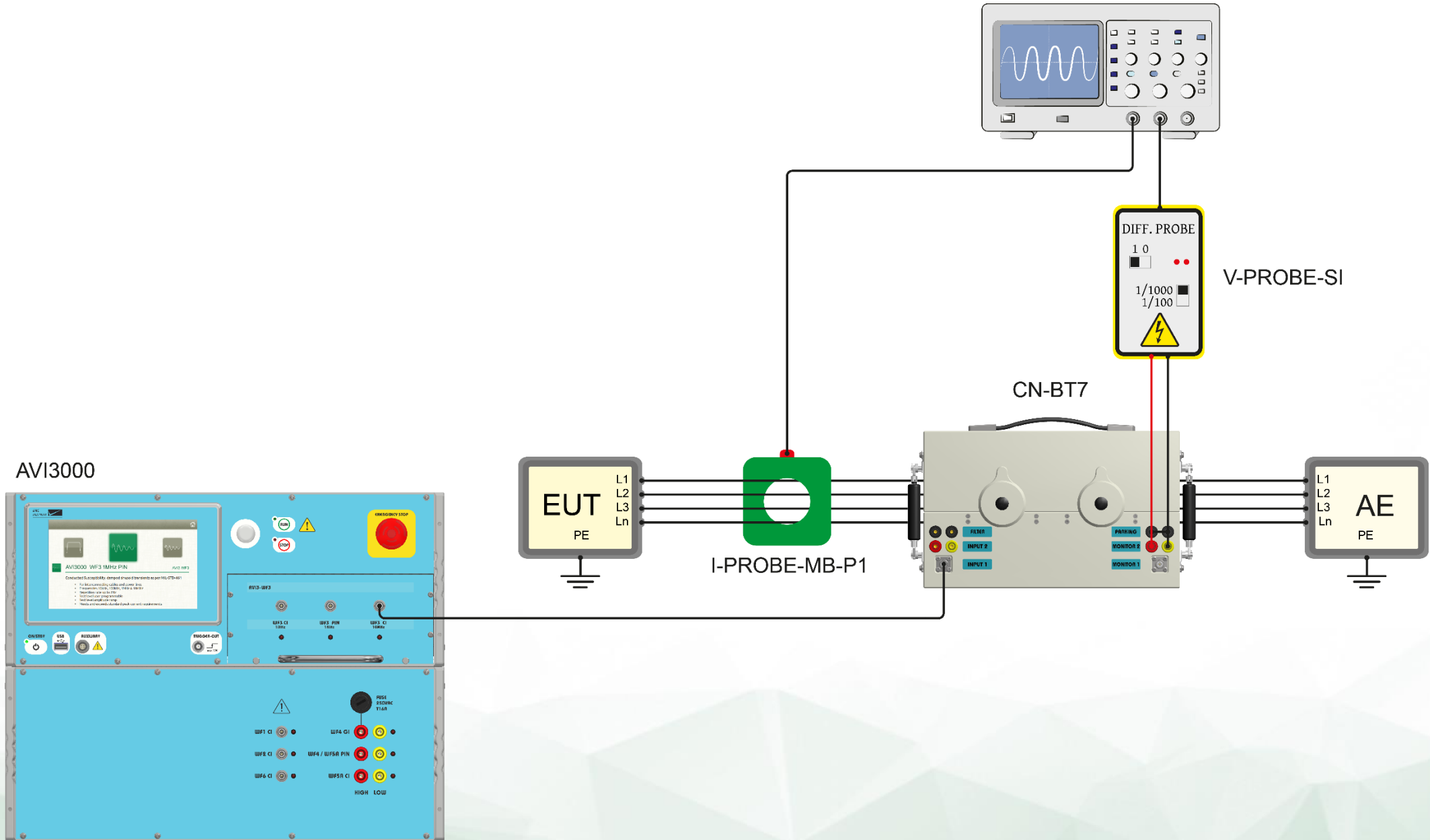

AVI3000

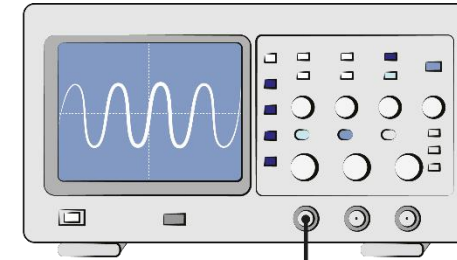
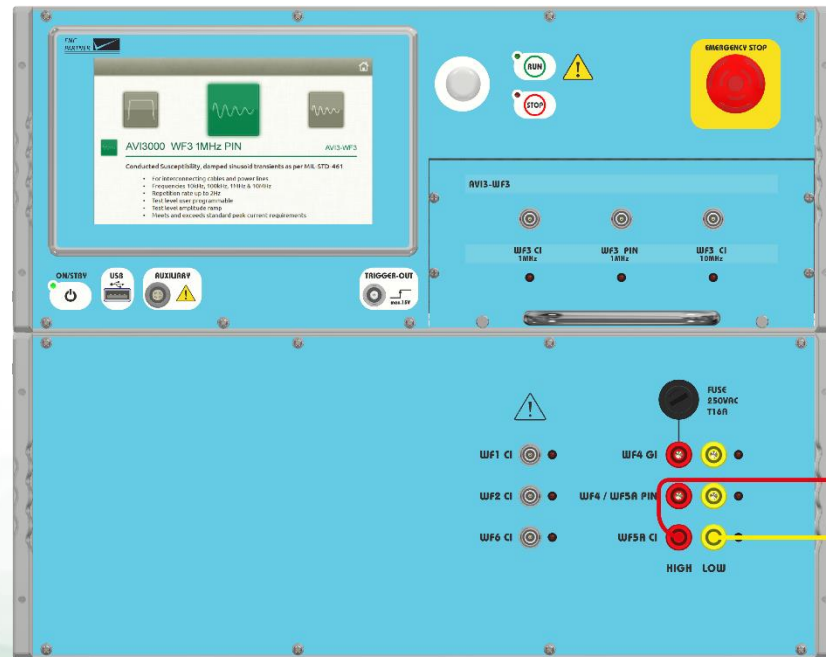

V-PROBE-SI

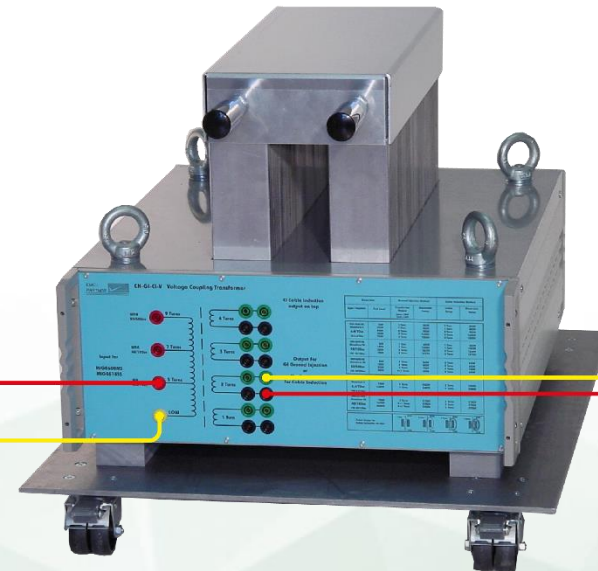
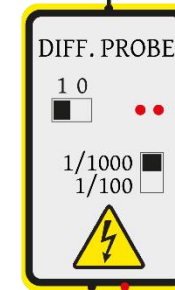

CN-GI-CI-V



Attenuator 20 dB between probe and DSO

AVI3000

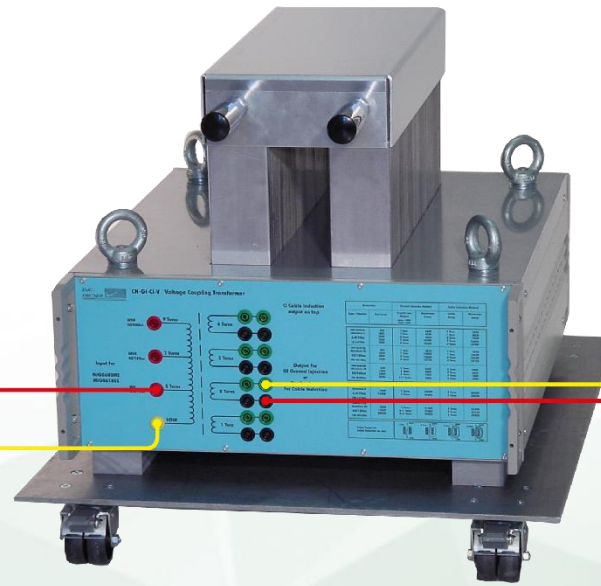
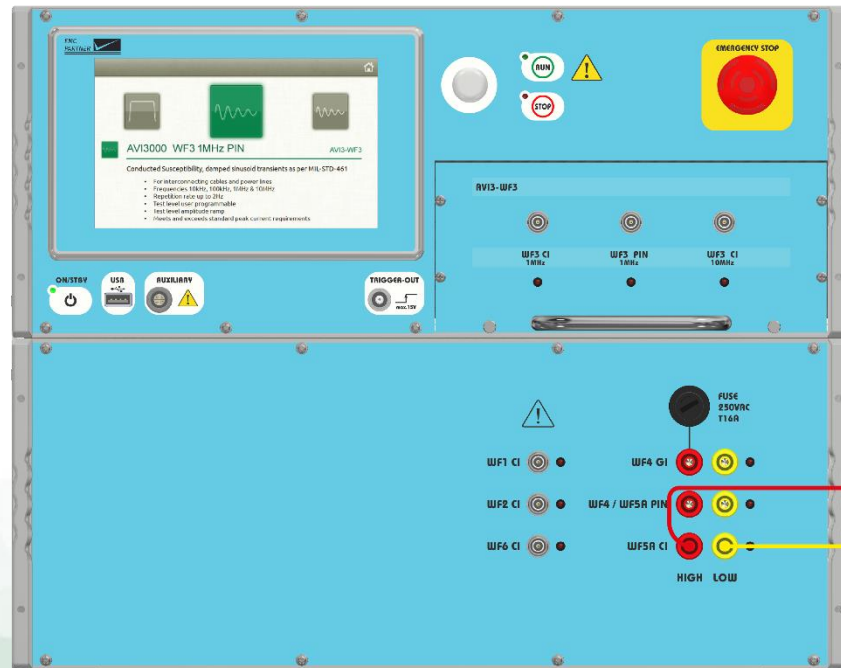

CN-GI-CI-V

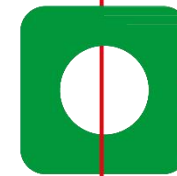
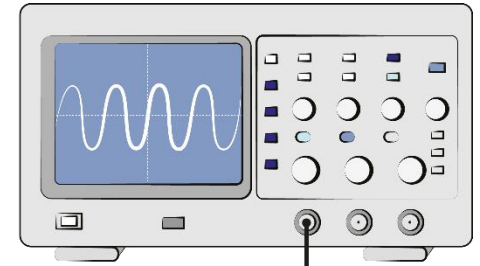

I-PROBE-MB-P1

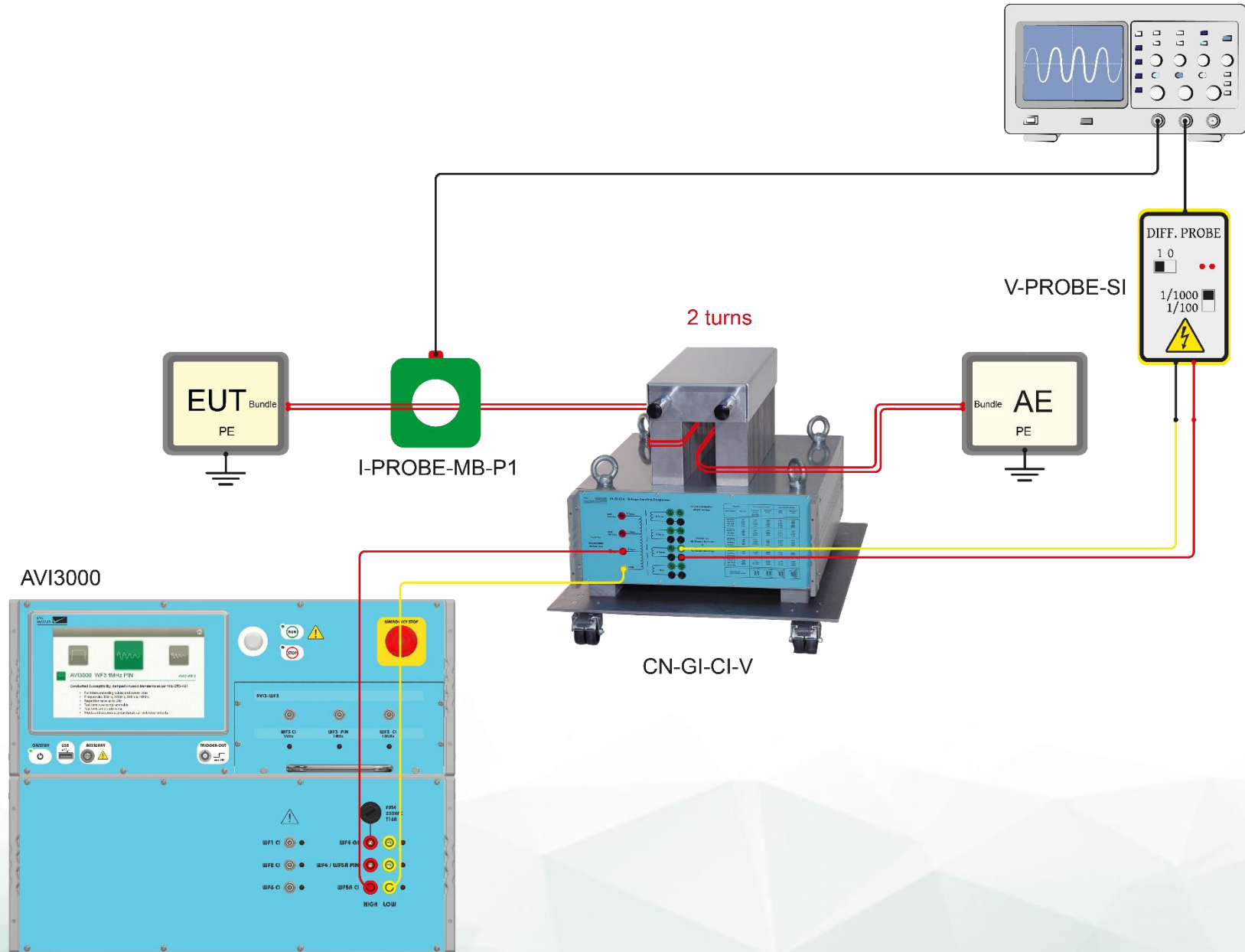

Attenuator 20 dB between probe and DSO

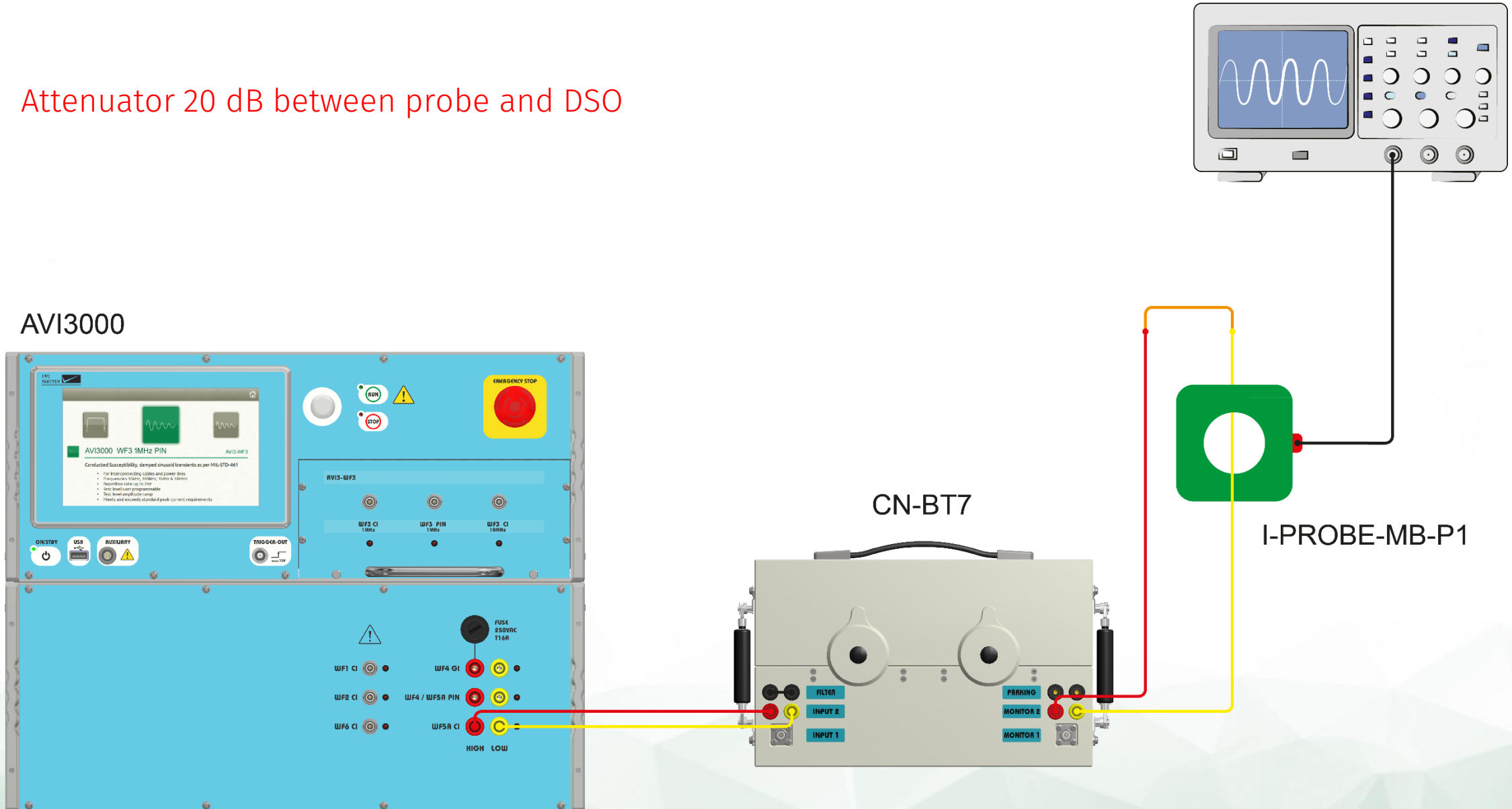

### AVI3000

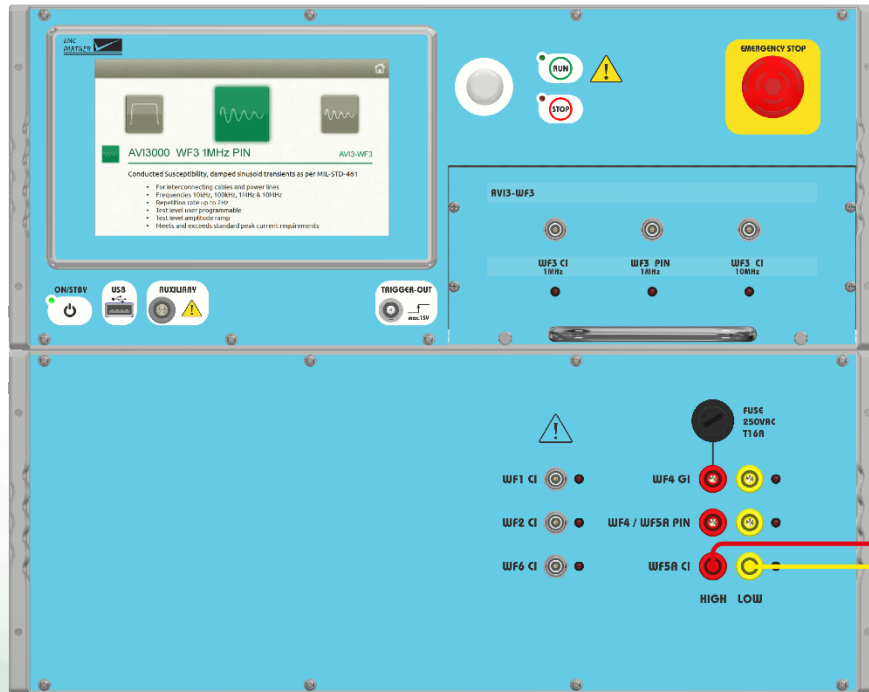

### V-PROBE-SI

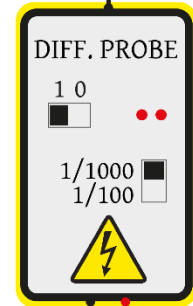

### CN-BT7

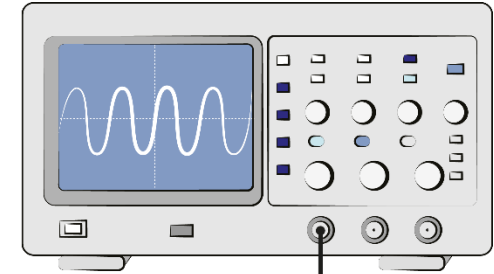
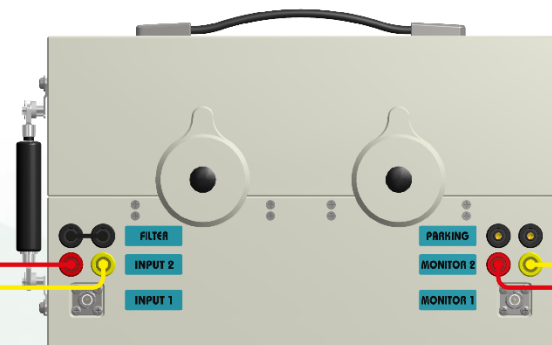

AVI3000

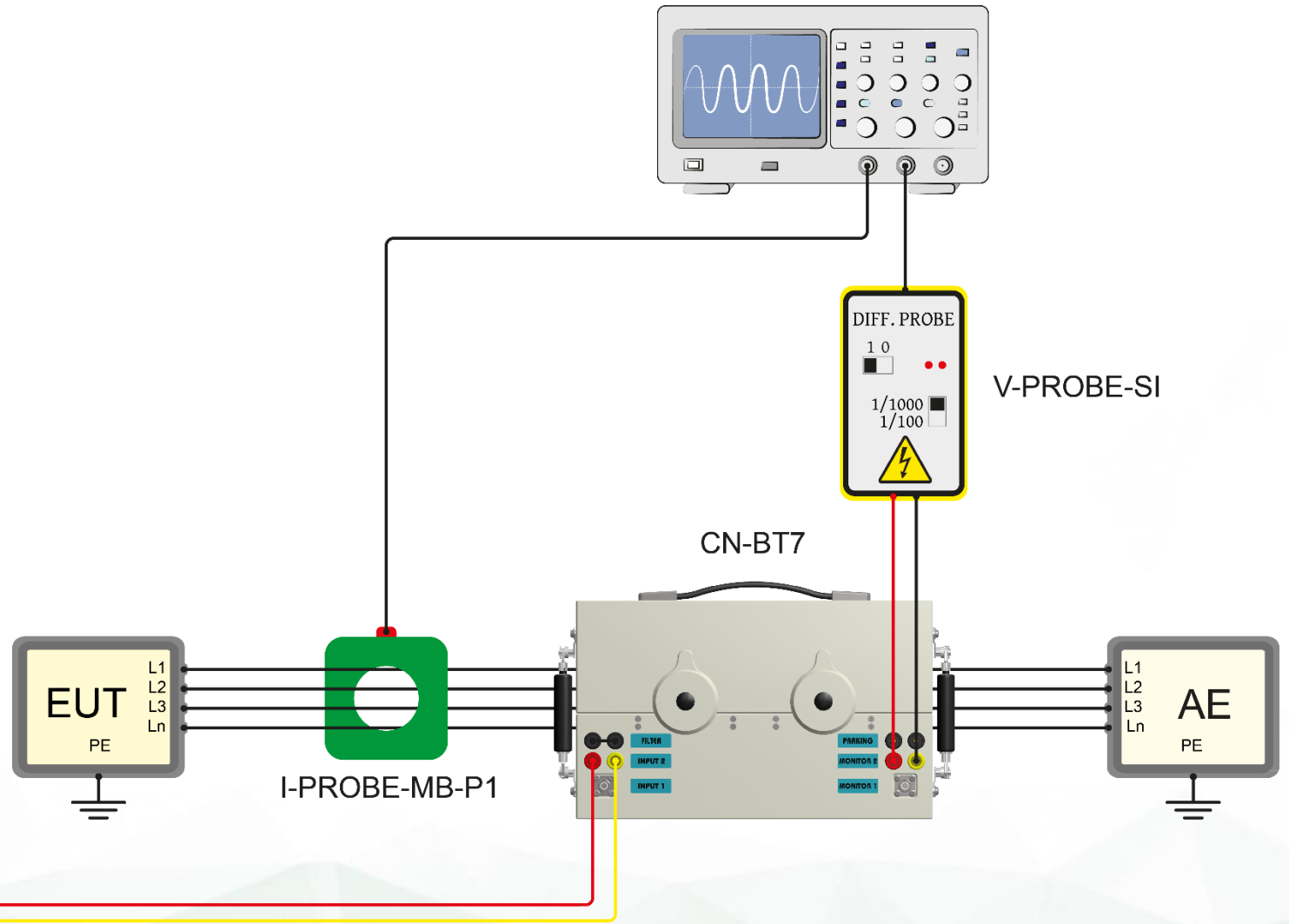
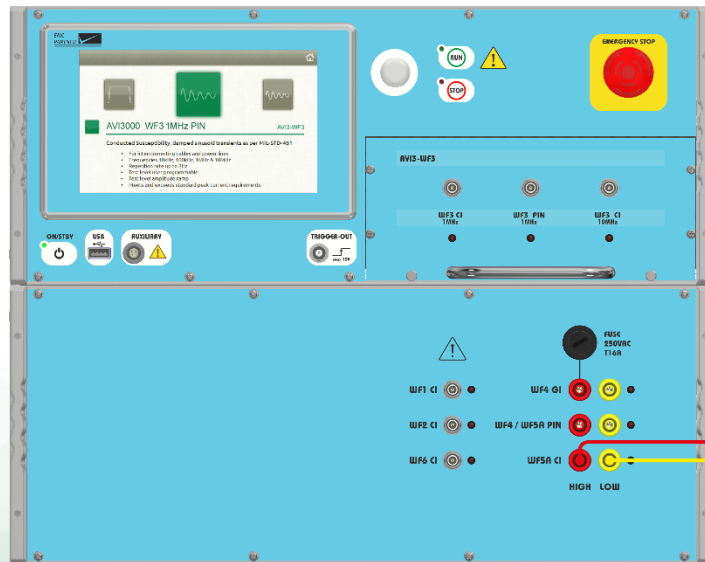

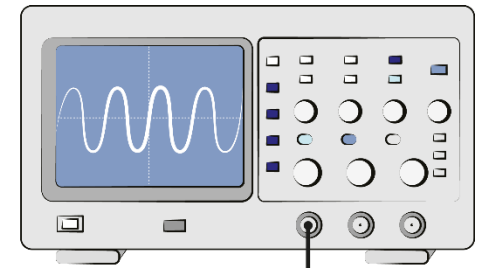

AVI3000

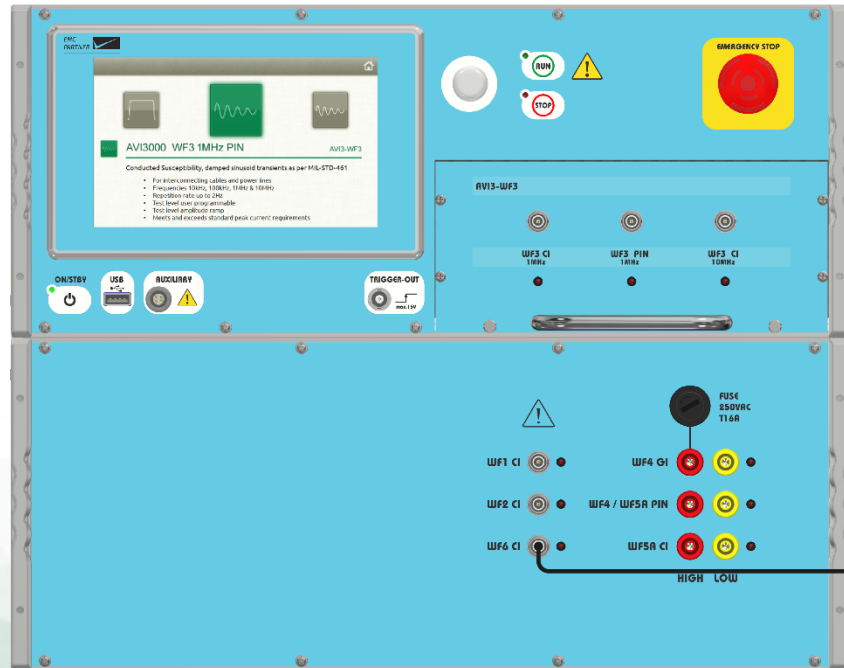

CN-BT7

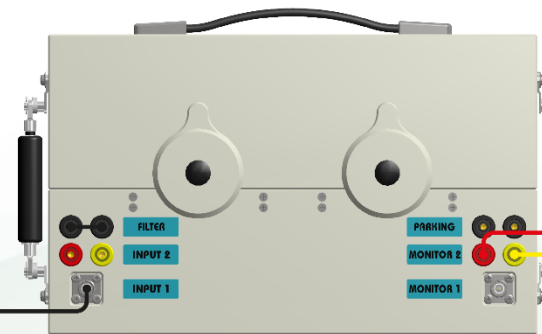

I-PROBE-MB-P1

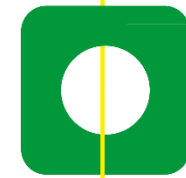

## AVI3000

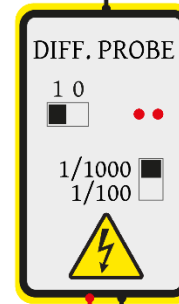
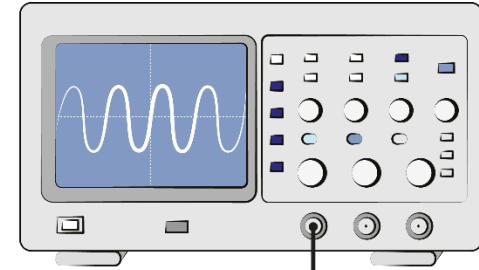
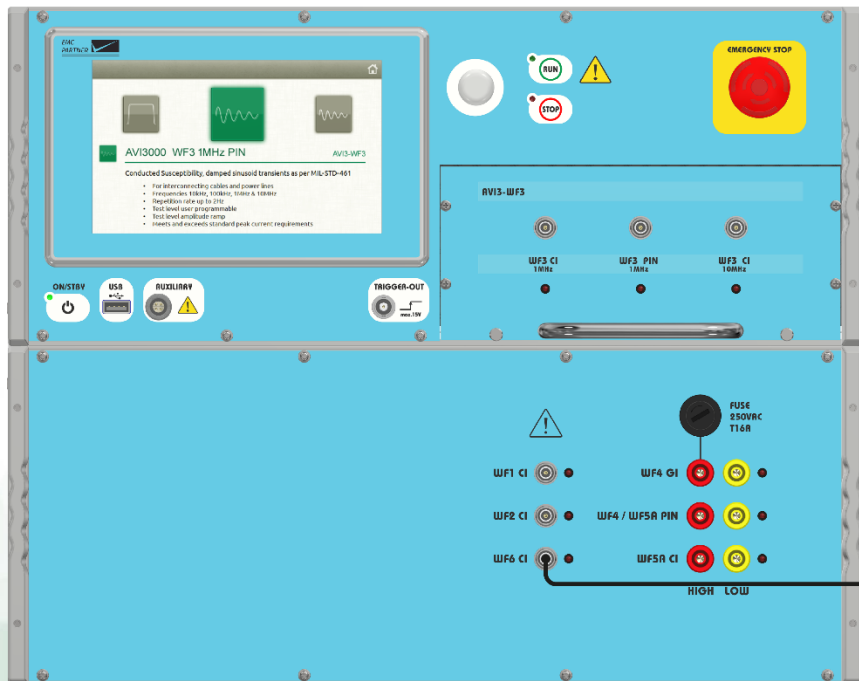

V-PROBE-SI

## CN-BT7

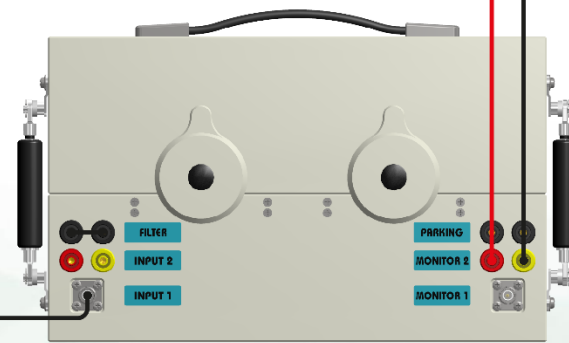

AVI3000

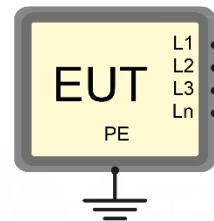
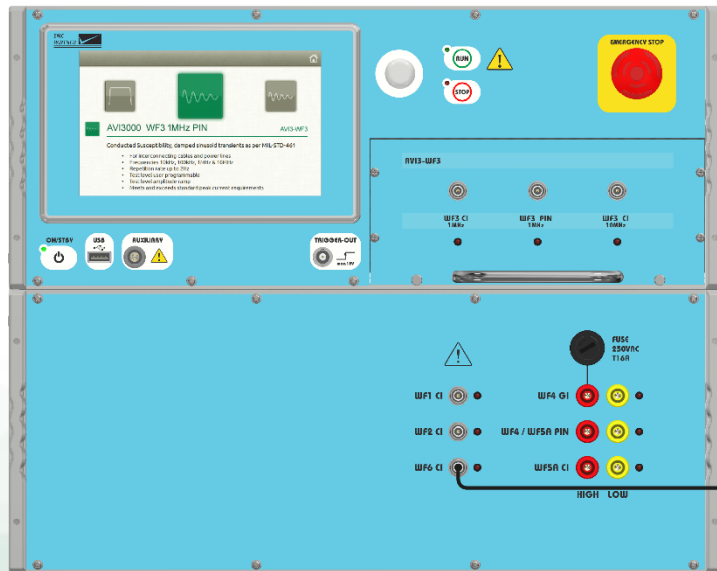

I-PROBE-MB-P1

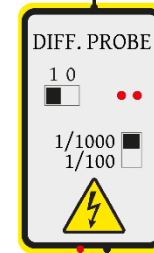
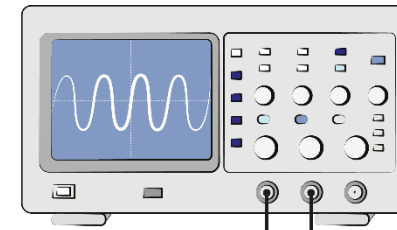
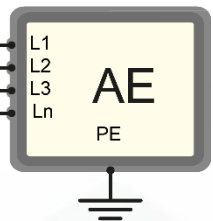
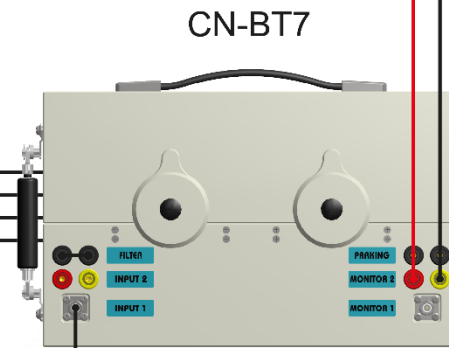

V-PROBE-SI



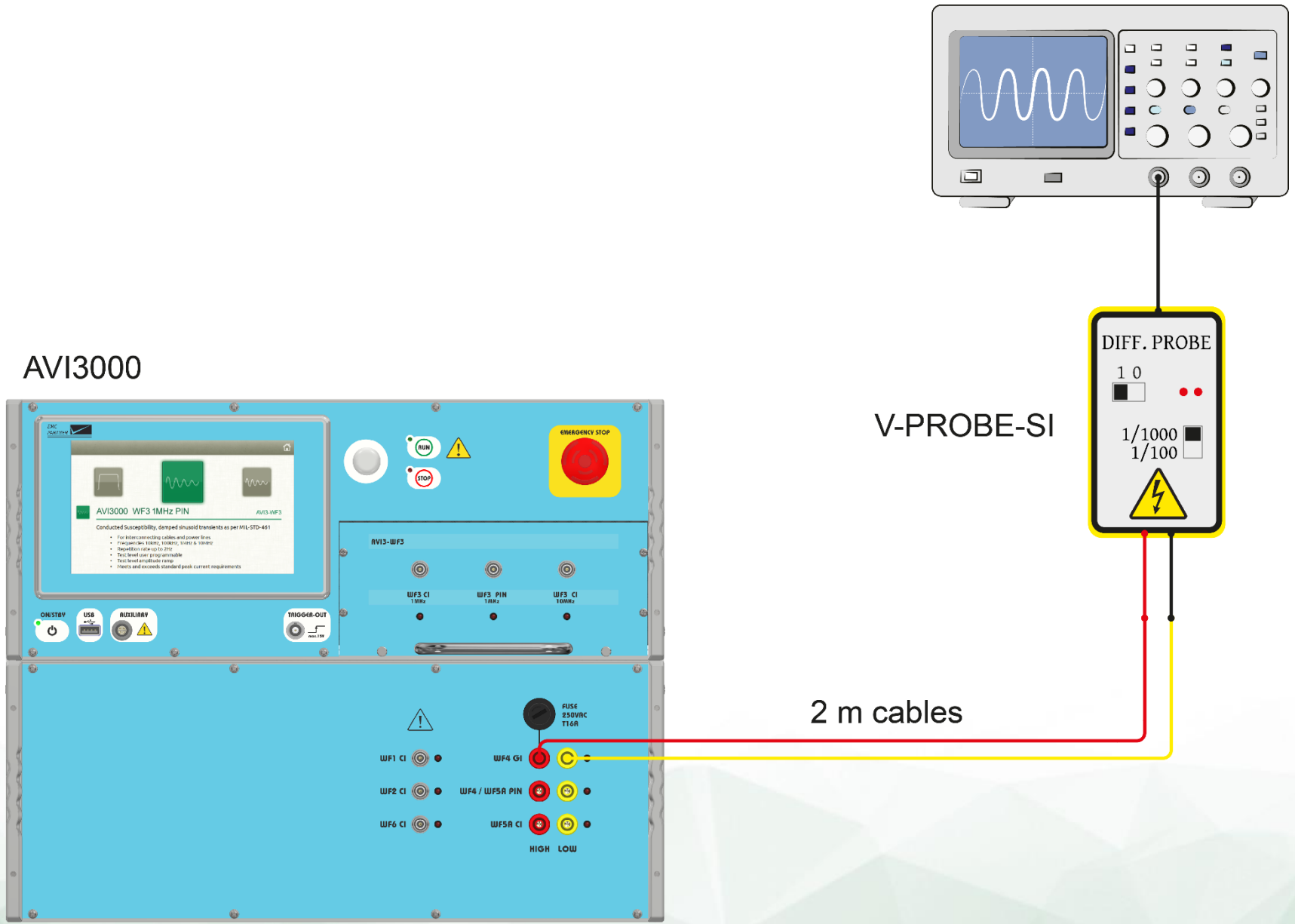

Attenuator 20 dB between probe and DSO

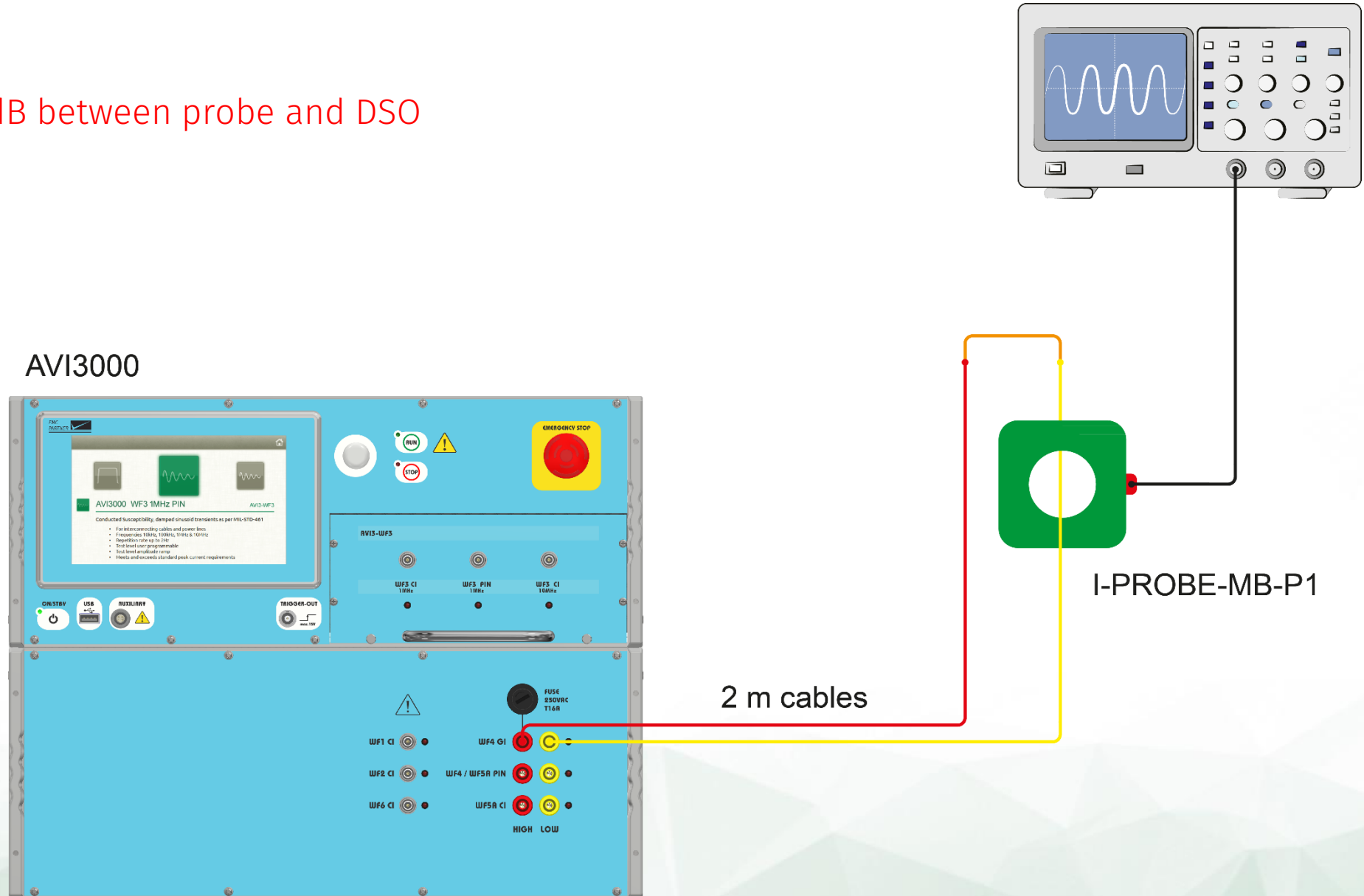

AVI3000

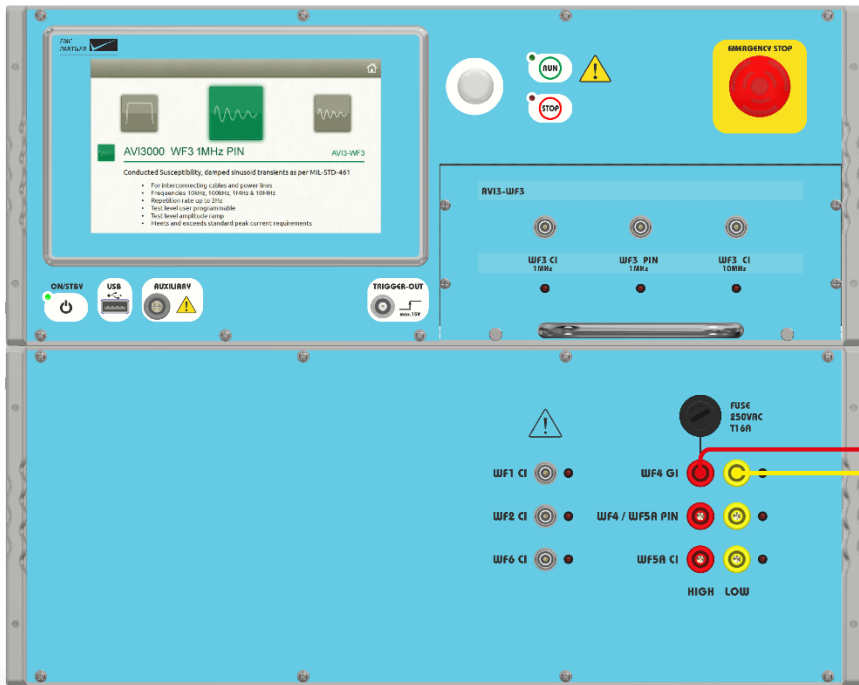

I-PROBE-MB-P1

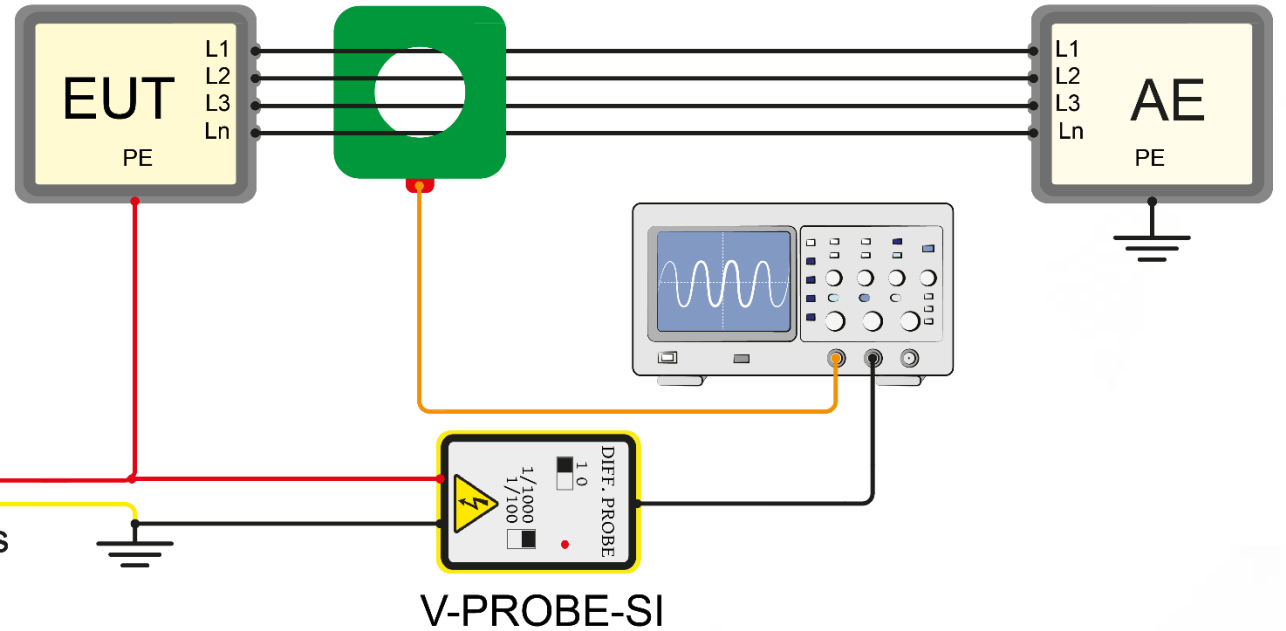

Attenuator 20 dB between probe and DSO

AVI3000

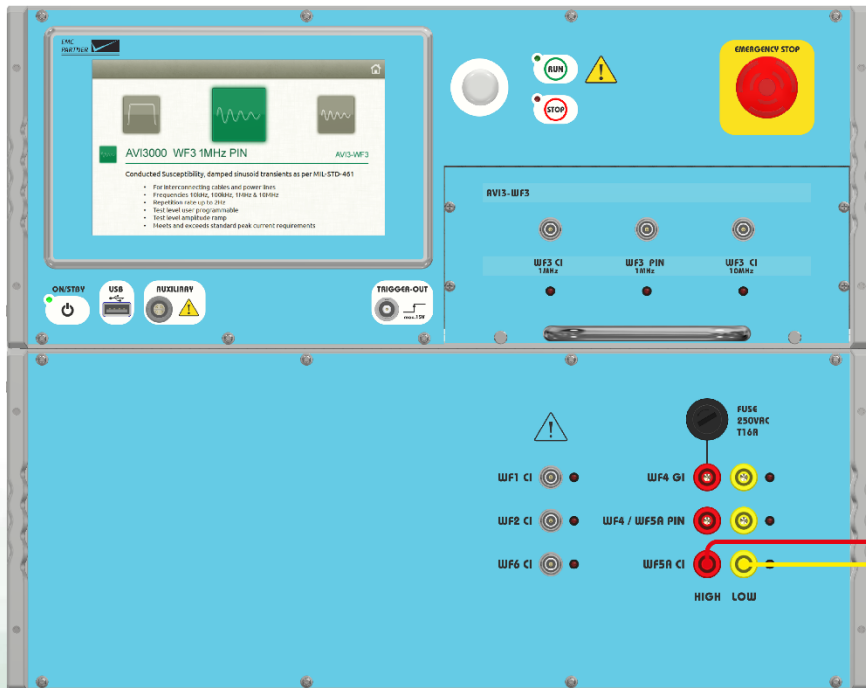

CN-BT7

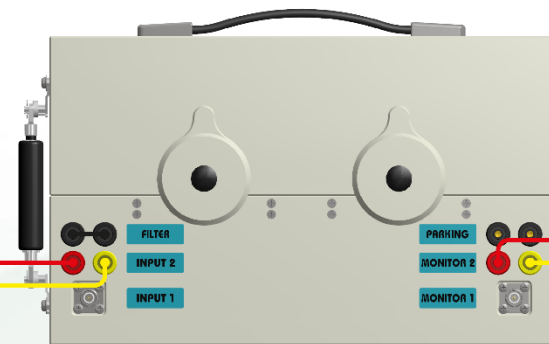

I-PROBE-MB-P1

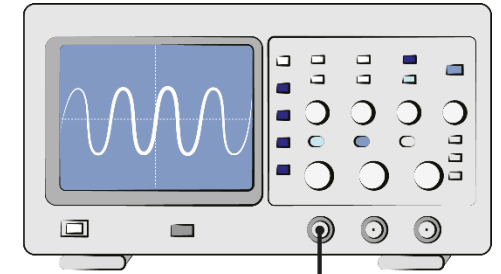
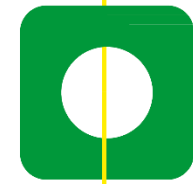

## AVI3000

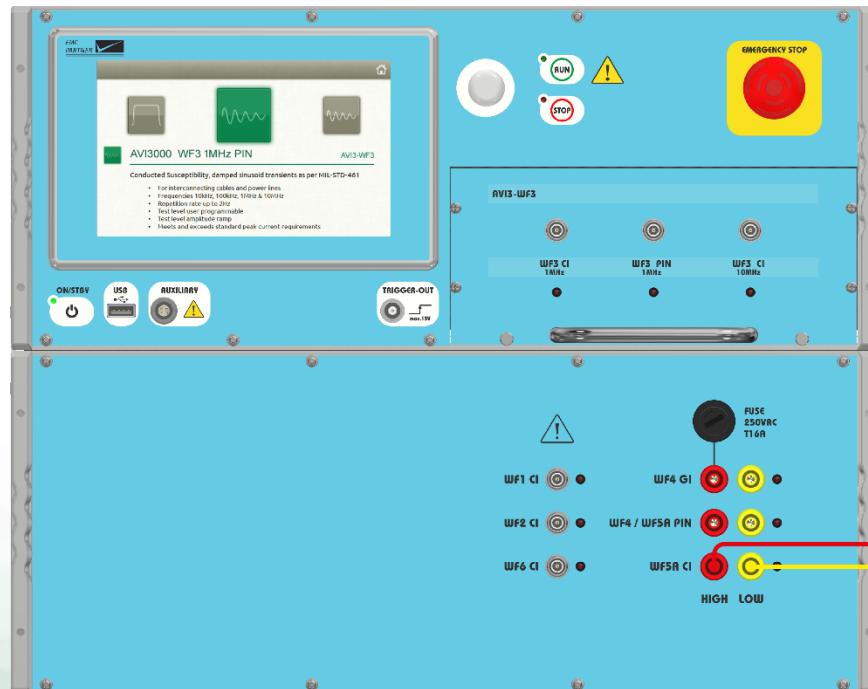

## V-PROBE-SI

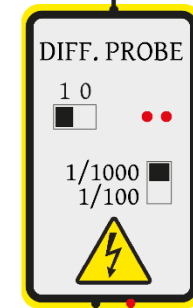

## CN-BT7

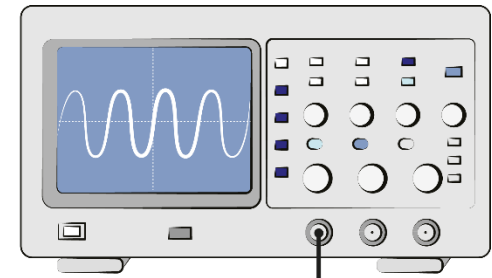
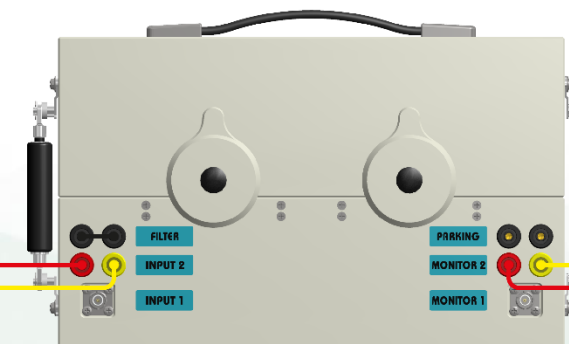

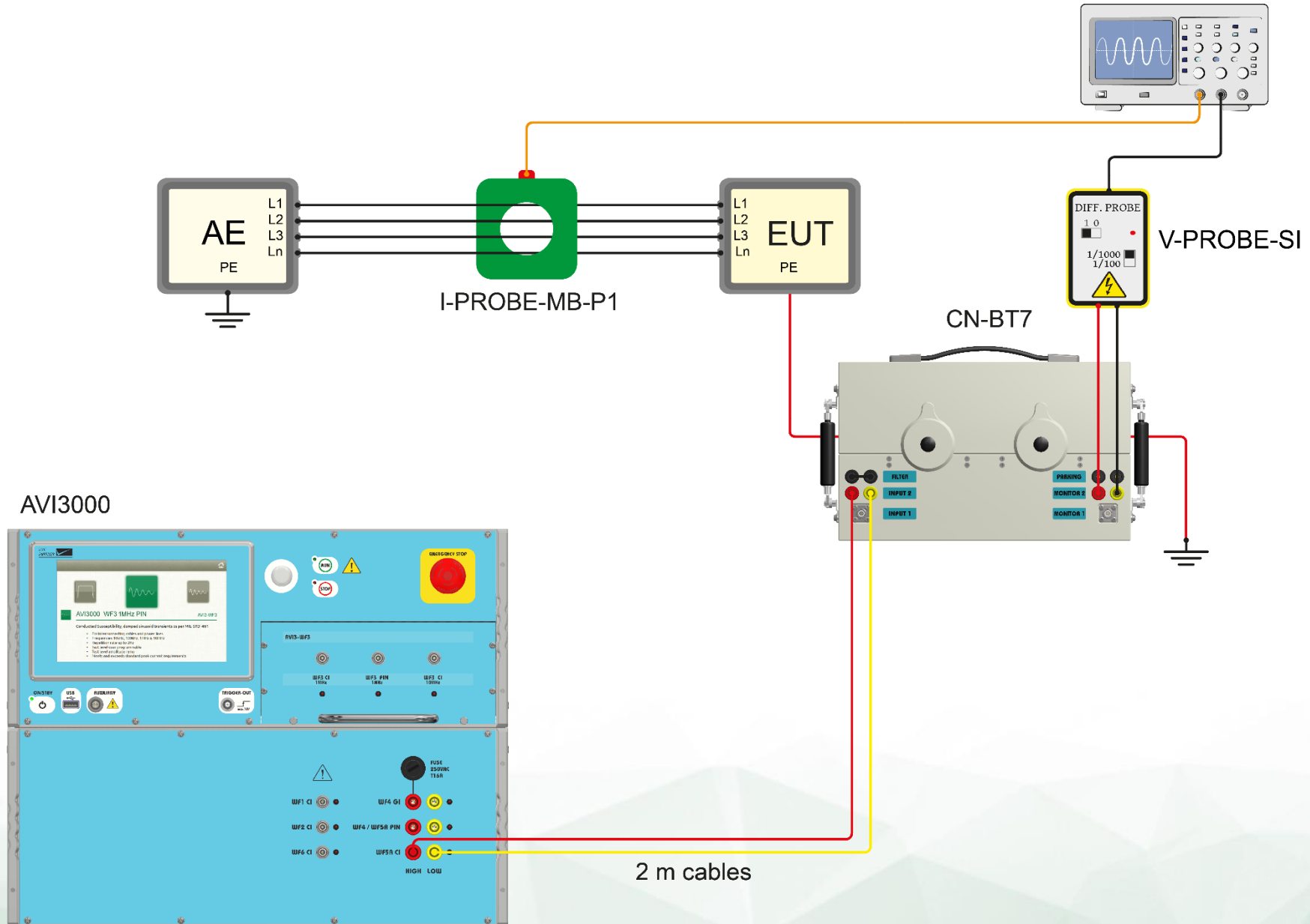

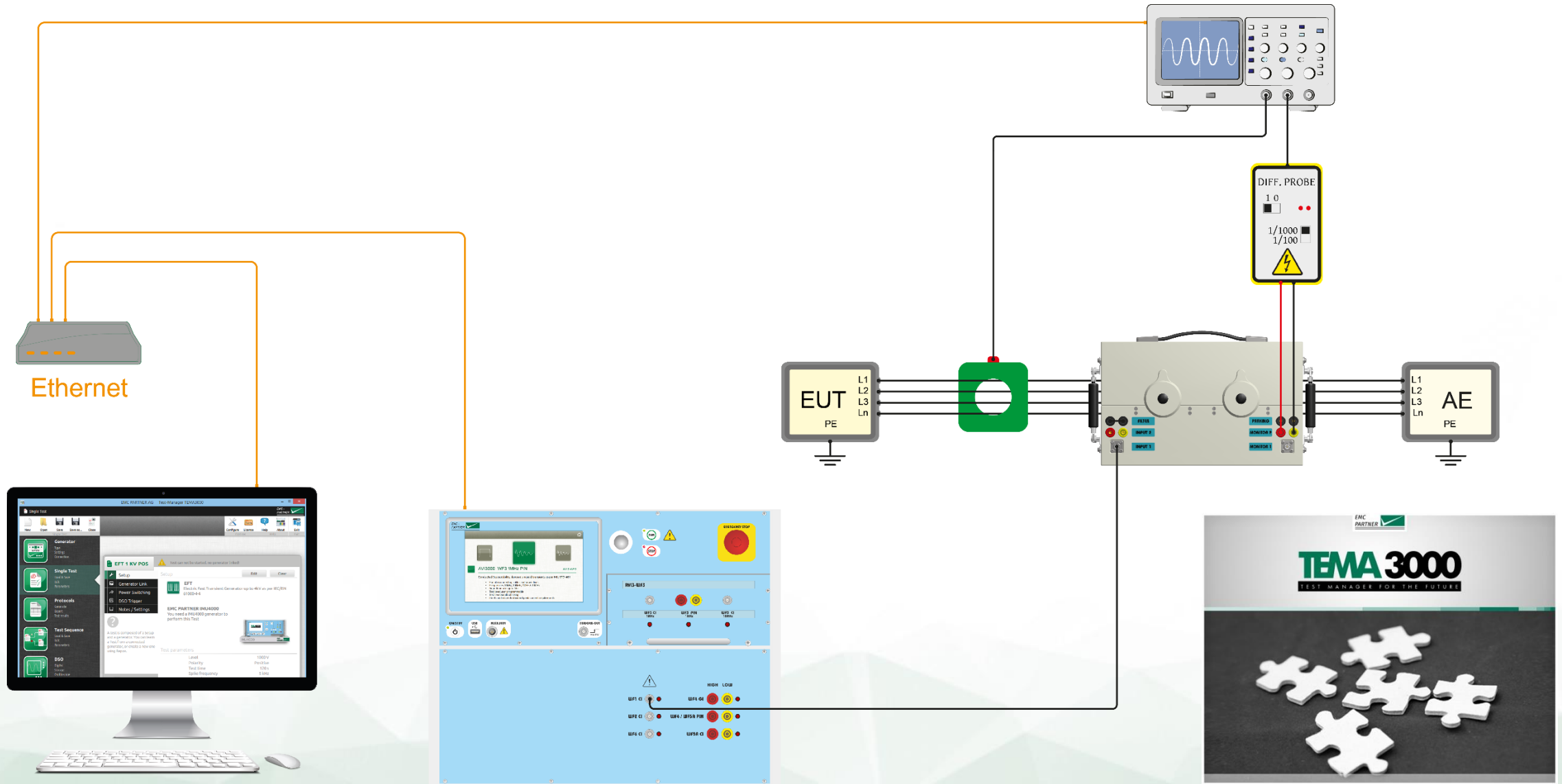



[www.emc-partner.com](http://www.emc-partner.com)