

MegaPulse

IMPULSE TESTER

D5-PF

Instruction Manual

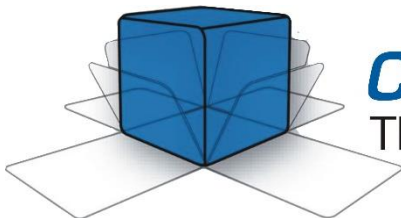

COMPLIANCE WEST USA

The blue box that tests. And tests.

Dear Customer:

Congratulations! Compliance West USA is proud to present you with your MegaPulse D5-PF Impulse Tester. Your instrument features a groundbreaking logic-controlled circuit design and ergonomic front panel and represents the latest in high voltage impulse testing.

To fully appreciate all the features of your new instrument, we suggest that you take a few moments to review this manual. Compliance West USA stands by your instrument with a full one-year warranty. If the need arises, please don't hesitate to call on us.

Thank you for your trust and confidence.

Table of Contents

Section 1	1
Introduction and Safety	1
An Introduction to Impulse Testing with the MegaPulse PF series tester	1
Safety Precautions	1
Test Personnel	1
Testing Area	1
Safety Techniques	2
Safety Markings	2
Using the MegaPulse PF Impulse Tester.....	3
Section 2	4
Getting Started.....	4
Unpacking and Inspection	4
Packaging.....	4
Product Package for D5-PF.....	4
Returning the Instrument	4
AC Line Voltage Requirements	5
Fuse Replacement	5
Section 3	6
Specifications and Controls	6
MegaPulse D5-PF Specifications	6
Front and Rear Panel Features.....	7
General High Voltage Electrical Diagram.....	12
Section 4	13
Operating Instructions	13
External Interlock	13
Front Keyboard and Voltage Knob Enable	13
Discharging Residual Voltage	13
Polarity Pulse Selection.....	14
Voltage Set Point Adjustment	14
Charge and Trigger a Pulse	14
Pulse Verification Procedure.....	15
Energy Measurement.....	18
Energy Measurement using System Included on D5-PF.....	18
Energy Measurement with an External Acquisition System	19
Measurement Terminals Y1 and Y2.....	19
Pass Fail Reference Built in	19
Section 5	21
Testing with the D5-PF.....	21
Section 6	23
Options	23
Circuit for Invasive Blood Pressure test (IEC 60601-2-34 Issue 2)	23
100X.....	23
Sine Wave Generator.....	24
Vacuum Trigger Relay	25
Section 7	26
Maintenance and Calibration	26
Service Information.....	26
General Maintenance.....	26
To avoid contaminating the PWB with oil from your fingers, handle it by the edges or wear gloves. If the PWB becomes contaminated, refer to the cleaning procedures given later in this section	26

Cleaning	26
Calibration Information	26
Technical Assistance	27

Section 1

Introduction and Safety

An Introduction to Impulse Testing with the MegaPulse PF series tester

The impulse test is designed to simulate impulse surges which occur in everyday life due to nearby lightning strikes, switching transients, and other high-frequency faults on the power distribution network. Impulse testing is the fundamental method for empirical verification of the adequacy of insulation. Other methods of ensuring adequate insulation (AC or DC Dielectric Withstand testing, measurement of over-surface creep age, through-air clearance, or distance-through-insulation) are all extrapolated from the results of impulse testing. The impulse test is performed to ensure that the insulation in question will be able to function properly when subjected to similar impulse surges in the field.

Safety Precautions

The impulse withstand test can generate voltages in excess of 5000V peak at potentially lethal current levels. Currents of as little as 5mA at 230 volts can cause death; the MegaPulse can deliver currents of more than 100 Amps peak for very short time duration. The D5-PF has been designed to minimize exposure to high voltages however, the potential for serious injury or death exists and personnel should be aware when they conduct this test.

CAUTION: Any use of this equipment other than as specified in this manual may result in a safety hazard.

Test Personnel

Personnel require special training to conduct the impulse test. They should understand electrical fundamentals clearly, and be aware that high voltage is adept and creative at completing a path to ground. Instructions should include a warning against any metal jewelry. Operators should not allow others in the testing area, especially when tests are being conducted. Organization is to be stressed. The operator should keep the area free of unused leads and equipment.

Testing Area

The area used for conducting the impulse test should be as remote as possible from normal production line activities. Only personnel conducting the test should be allowed in the area, and it should be taped or roped off to preclude casual entry by other employees. In addition, the area should be marked "WARNING - HIGH VOLTAGE TESTING" or the equivalent to warn others of the nature of the testing taking place.

The bench being used should be non-conductive, and any exposed metal parts should be tied together and grounded. If a conductive surface must be used, it should be grounded. Because of sparking during an impulse test failure, it is not safe to conduct impulse testing in combustible atmospheres. Make sure that the equipment is in a ventilated area and that the rear fans are free from obstruction.

It is imperative that a good ground be provided to the MegaPulse tester. Before connecting the equipment, ensure that the building wiring provides a low-resistance ground. If the MegaPulse tester is used on a high-resistance grounding circuit, dangerous high voltages may be present to the operator.

CAUTION: Plug on power cord is disconnect device. The power to the Testing Area should be provided with an **easily reached shutoff switch** which can be actuated by personnel outside the area if needed.



Safety Techniques

The high voltage circuit of the MegaPulse D5-PF can be shut off at any time by turning OFF the rear power switch. Always press TRIGGER to discharge the tester before turning OFF.









The MegaPulse tester is provided with a digital **VOLTAGE ADJUST** knob on the front panel. This voltage setting should always be confirmed by pressing the VOLTAGE ADJUST knob before starting any test.

The MegaPulse tester is provided with a **CHARGE** switch that is in the unarmed "Standby" setting when the tester is first turned ON. When the yellow **CHARGE** button is lit, the tester will not provide high voltage until the **CHARGE** Button and the **TRIGGER** Button have been pressed in order. To prevent inadvertent operation, the operator should be instructed not to press the **CHARGE** Button until the test is ready.

The MegaPulse tester has been designed for one-touch operation with the right hand. If possible, it should be set up to the left and in front of the equipment under test. The equipment under test should be connected to the MegaPulse tester and then left alone by the operator. After the operator is clear of the Tester and the equipment under test, the operator should turn the rear-panel power switch to ON, confirm or adjust the Voltage Set Point, then press the **CHARGE** Button and wait until the front meter reaches the voltage selected, then press the **TRIGGER** Button, with his right hand. This will allow the greatest separation between the operator and the test being conducted.

The MegaPulse PF tester is designed to bleed the high voltage away after the test has concluded. To ensure that any voltage present in the equipment being tested has been completely bled away, the operator should not unplug the equipment under test from the MegaPulse until the front panel meter reads a safe level (40 volts or less is generally considered a safe level). Pressing the TRIGGER button before disconnecting main power (or turning the equipment off) will ensure that the internal capacitors are discharged as much as possible.

Safety Markings

	Direct Current		On (Power)
	Alternating Current		Off (Power)
	Refer to instructions		Caution, possibility of electric shock
	Earth (ground) TERMINAL		High Voltage

Using the MegaPulse PF Impulse Tester

The impulse test involves high voltage and caution should be exercised when using the tester. The **RETURN** lead is referenced to building ground when properly connected. However, both the **OUTPUT** and **RETURN** leads must always be treated as **Hazardous** whenever the power switch of the MegaPulse is in the ON position.

The MegaPulse impulse tester generates the impulse waveform only; it does not determine Passing or Failing results. It is the operator's responsibility to monitor the output waveform and determine Passing or Failing results. In monitoring the impulse waveform, consider the following points: The Impulse waveform is high voltage and high frequency (short duration). Always ensure that the measuring instrument (usually an oscilloscope with a high-voltage probe) is rated for the voltage involved, and that the frequency response of the instrument and probe can measure the output waveform of the MegaPulse Impulse Tester. A measuring instrument or probe with a low frequency response will result in erroneous readings that could be misread.

CAUTION

High voltage generated by the MegaPulse tester is exposed during this test. A risk of shock exists. Exercise care when using the MegaPulse unit.

Pressing the **POLARITY** switch on the front panel can change the polarity of the output waveform. The polarity is Normal when the **NOR** indicator is lit. In this case, the high voltage will appear on the **OUTPUT** as a positive pulse relative to the **RETURN** jack. When the polarity switch is in the Reverse position (**REV** indicator is lit), the high voltage will appear on the **OUTPUT** as a negative pulse relative to the **RETURN** jack. The polarity switch only operates when the **CHARGE** LED is lit, i.e. the output is not charged.

Note that the voltage meter may indicate that some residual voltage is present on the main storage capacitor, even when the tester is first turned ON. This is due to inherent charging of the internal capacitors. Pressing the **TRIGGER** switch will discharge the capacitors (Be sure not to touch the output and return leads when pressing the trigger switch).

Note that the peak amplitude of the measured output waveform is proportional to the voltage that is read on the front panel of the MegaPulse, but it will always be somewhat lower. This is because the meter on the MegaPulse is measuring the voltage on the main impulse storage capacitor. This voltage will intentionally dissipate to some extent before reaching the output leads. Therefore, it is important to measure the peak amplitude of the output waveform, and adjust the output of the MegaPulse accordingly.

Section 2

Getting Started

This section contains information for the unpacking, inspection, preparation for use and storage of your Compliance West product.

Unpacking and Inspection

Packaging

Your Tester is shipped in a special protective container that should prevent damage to the instrument during shipping. Check the shipping order against the contents of the container and report any damage or short shipment to Compliance West USA. Please save the shipping carton and packing material for the carrier's inspection. Our customer support department will assist you in the repair or replacement of your instrument. Please do not return your product without first notifying us and receiving an RMA (return material authorization) number. To receive an RMA number, please contact our customer support department at (1-800-748-6224).

Product Package for D5-PF

The container includes the following:

	Description	Part Number
D5-PF Tester	MegaPulse Tester	
	User Manual	
	High Voltage Test Lead, Red	HVLR (Qty 3)
	High Voltage Test Lead, Black	HVLB (Qty 2)
	High Voltage Jumper, Red	HVLEC13, Option 100X includes one Jumper and option 34 also includes one Jumper. Total Qty 2 if all options are ordered.
	18 AWG AC Power Cord	70-101
TestMinder	User Manual	
	Software CD	MegaPulse TestMinder P/PF
	RS232 cable	60-134
	USBD box	00-USBD BOX
	USB cable	60-221

Returning the Instrument

When it's necessary to return the instrument for servicing or calibration, repackage the instrument in its original container, please include all accessories and test leads. Indicate the nature of the problem or type of service needed. Also, please mark the container as "FRAGILE" to insure proper handling.

If you do not have the original packaging materials, please follow these guidelines:

- Wrap the instrument in a bubble pack or similar foam including all the included cables.
- Use a strong double-wall container that is made for shipping instrumentation.
- Use a layer of shock absorbing material 70 to 100mm (3 to 4 inch) thick around all sides of the instrument. Protect the control panel with cardboard.
- Seal the container securely.
- Mark the container as "FRAGILE" to insure proper handling.

- Please contact Compliance West USA (1-800-748-6224) to inform about the service for your instrument.

AC Line Voltage Requirements

AC line voltage requirements for your Tester are noted on the rear panel of the instrument. Do not connect the instrument to a different voltage source. The cord packaged with your MegaPulse Tester is for use in the United States. If another power cord must be used, the cord must be rated for the maximum current noted on the rear panel. It must also meet the requirements of IEC 227 or IEC 245, and mains cords that are certified or approved by any recognized national test house are regarded as meeting this requirement.

Fuse Replacement

There is a user-replaceable fuse (F1) located on the rear panel of the instrument. It is located behind a door in the Power Inlet-Power Switch-Fuse Holder device. The fuse rating is noted on the rear panel. Do not attempt to replace it with a fuse of any other rating.

Use the following procedure to replace the fuse F1:

1. Turn the power switch to the OFF position.
2. Unplug the instrument from the source of supply.
3. Remove the power inlet cord from the instrument.
4. Using a small screwdriver, pry open the fuse holder door.
5. Replace the fuse with a new one of the correct rating.
6. Replace the fuse holder door and power inlet cord.

Section 3

Specifications and Controls

MegaPulse D5-PF Specifications

ELECTRICAL

Output Voltage:	0 - 5000 V tolerance $\pm 1\%$
Main Capacitance:	32 μF $\pm 5\%$ (Dry capacitor type, 2.5 million cycles life)
Inductances:	500 μH and 25 mH $\pm 5\%$
Main Resistances:	100 Ω , 50 Ω and 400 Ω $\pm 1\%$ non-inductive.
Voltage Control:	Digital Set point adjusted by frontal VOLTAGE knob or by PC TestMinder.
Polarity Control:	Positive and Negative. Alternating control available with optional computer control.
Voltage Display:	4 Digit LED Display.
Voltage Meter resolution:	2V
Duty Cycle:	1 pulse every 20s.

Input Voltage:	120V~ 50/60Hz 230V~ 50/60Hz (CE for EU)
----------------	--

ENVIROMENTAL

Operating Temperature:	15 - 40 °C
Relative Humidity Range:	0 - 90% non-condensing
Altitude	0 - 3000 meters

GENERAL

Dimensions:	17" wide x 10.5" high x 17" in deep
Weight:	45 lbs. approx.

Front and Rear Panel Features

Before using your Tester, take a few minutes to become familiar with the use of its controls, indicators and connectors. The front panel features of the MegaPulse are shown in Figure 1 and described in Table 1. The rear panel features of the MegaPulse are shown in Figure 2 and described in Table 2.

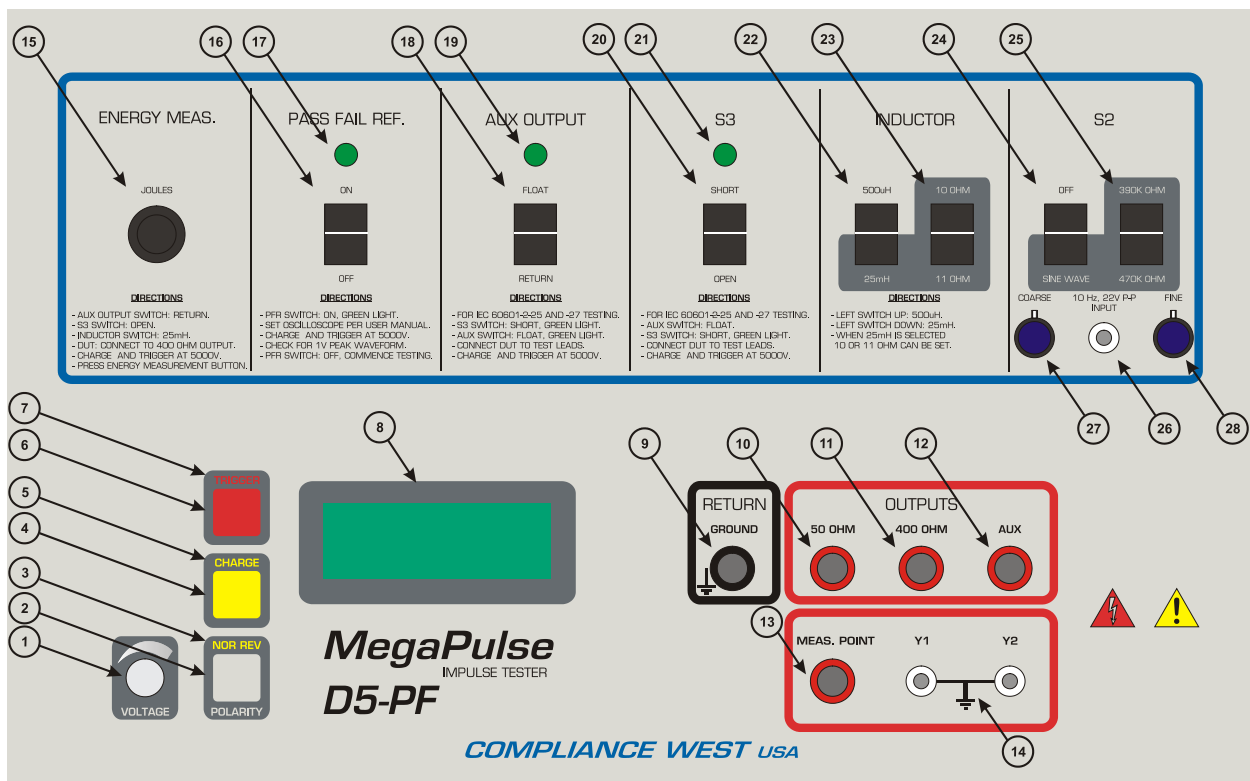

Figure 1 Controls, Indicators, Connectors – MegaPulse D5-PF Front Panel

ITEM	NAME	FUNCTION
1	VOLTAGE Adjust Knob	Adjust the digital voltage set point in the tester. Press the voltage knob to display the voltage set point. This setting will blink for a few seconds on the front meter. Turn Clockwise to increase the Voltage Setting Point before pressing CHARGE button.
2	POLARITY switch	Toggles the output pulse polarity from Normal (Positive) to Reverse (Negative). The pulse will appear on the Output jack relative to the return jack. The polarity switch only operates when the CHARGE indicator is lit and the voltage on the display meter is less than 200V. The polarity is Normal when the NOR indicator is lit and Reverse when the REV indicator is lit.
3	NOR REV indicator	This indicates the state of the Output Polarity switch. NOR indicates Normal (Positive) position. REV indicates Reverse (Negative) position.
4	CHARGE switch	Charge the capacitor to the voltage set point. The CHARGE indicator will turn off after the CHARGE switch is pressed, and the TRIGGER indicator will turn on.
5	CHARGE indicator	This yellow indicator is lit when the tester is ready to charge. CHARGE indicator will go out after pressing CHARGE button. CHARGE and TRIGGER Indicators will be blinking if the Interlock Switch is open.
6	TRIGGER switch	Triggers the output impulse waveform. The impulse waveform will appear across the output leads.
7	TRIGGER indicator	This red indicator is lit to when the tester can be triggered. TRIGGER indicator will go out after pressing TRIGGER button. TRIGGER and CHARGE Indicators will be blinking if the Interlock Switch is open.
8	VOLTAGE meter	This meter displays the voltage on the internal high voltage capacitor. The meter will start flashing at 5100V or above to indicate that the voltage is at the maximum limit. Displays the output voltage set point (Blinking mode). If the Keyboard is locked, the display will show OFF. If the Digital Voltage knob is locked, the display will show OFF
9	RETURN jack	This is the return for the impulse waveform. This jack is referenced to the chassis of the MegaPulse, and is referenced to earth ground as long as the MegaPulse is properly grounded. Even though this jack is referenced to ground, it should be treated as HAZARDOUS whenever the MegaPulse is turned ON.
10	50 ohm OUTPUT jack	The impulse waveform appears on the OUTPUT jack, referenced to the RETURN jack. When the POLARITY switch is in the Normal position (NOR indicator is lit) the output will be a positive pulse. When the POLARITY switch is in the Reverse position (REV indicator is lit) the output will be a negative pulse.

ITEM	NAME	FUNCTION
11	400 ohm OUTPUT jack	The impulse waveform appears on the OUTPUT jack, referenced to the RETURN jack. When the POLARITY switch is in the Normal position (NOR indicator is lit) the output will be a positive pulse. When the POLARITY switch is in the Reverse position (REV indicator is lit) the output will be a negative pulse.
12	AUX OUTPUT jack	The AUX OUTPUT is connected at the grounded side of the 100ohm resistor, but this output is only used when it is required to float the 100ohm resistor.
13	MEAS. POINT jack	Used to perform the Pass/Fail reference test.
14	Y1 – Y2 outputs	These differential outputs are to be connected to two different channels of an oscilloscope. The outputs are then subtracted and the resulting waveform is used to judge acceptability of the EUT.
15	ENERGY MEAS. switch	By pressing this switch, the front display will blink showing for a few seconds the energy measurement from the last pulse. Note: This function only works when the MegaPulse unit is not charging or triggering.
16	PASS FAIL REF. switch	The D5-PF Includes the Pass-Fail reference circuit built in, to use properly refer to the directions on front panel.
17	PASS FAIL REF. indicator	This Green indicator is lit to show that the pass/fail reference is connected (AUX OUTPUT must be grounded).
18	AUX OUTPUT switch	It is used to control the AUX output position (Floated or Grounded).
19	AUX OUTPUT indicator	This Green indicator is lit to show that AUX OUPUT switch is set on the FLOAT position.
20	S3 switch	Used for common mode testing of figure 201.103, S3 switch should be closed only when auxiliary output is floated from ground.
21	S3 indicator	This Green indicator is lit to show that S3 switch is set on the SHORT position.
22	INDUCTOR left switch	This switch allows the user to select the inductance value between 500uH and 25mH.
23	INDUCTOR right switch	This switch allows the user to select the inductance resistance value between 10 ohm and 11ohm when INDUCTOR left switch is on 25mH.
24	S2 left switch	This switch is provided to protect the Signal Generator from the output pulse of the D5-PF when OFF, and to allow the required 20V p-p signal to be injected when SINE WAVE is selected.
25	S2 right switch	This switch is enable only when S2 left switch is on SINE WAVE position and allows selecting between 390K or 470K ohm.
26	BNC INPUT 10Hz, 22Vp-p	BNC Input provided on front panel is for connecting the output signal generator. See Figure 12 Part 9A. Note: If the unit includes the Sine Wave Generation option, the item 26 will be a BNC OUTPUT 10Hz, for monitoring the Sine Wave with an oscilloscope.
27	COARSE adjustment (optional)	It is used to adjust the amplitude of the sine waveform. Only for models with Sine Wave Generation option.
28	FINE adjustment (optional)	It is used to fine adjust the amplitude of the sine waveform. Only for models with Sine Wave Generation option.

Table 1. Controls, Indicators, Connectors – MegaPulse D5-PF Front Panel

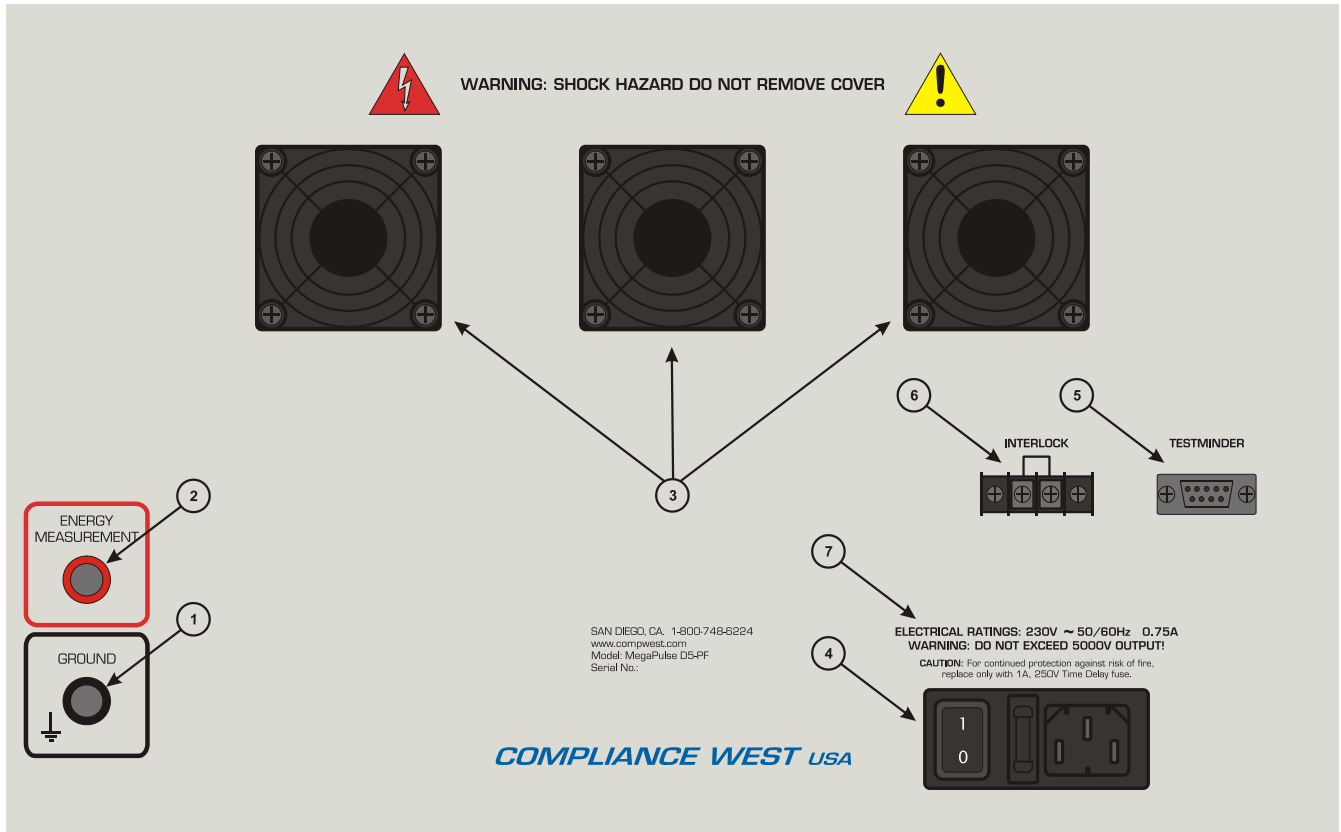

Figure 2. Controls, Indicators, Connectors – MegaPulse D5-PF Rear Panel

ITEM NO.	NAME	FUNCTION
1	Ground for Energy Measurement	This jack is used along with the ENERGY MEASUREMENT jack to calculate the energy. This jack is referenced to the chassis of the MegaPulse, and is referenced to earth ground as long as the MegaPulse is properly grounded. Even though this jack is referenced to ground, it should be treated as HAZARDOUS whenever the MegaPulse is turned ON.
2	Energy Measurement jack	This jack is necessary to verify the value of the 100 ohm resistor. The 100 ohm resistor value is measured between the ENERGY MEASUREMENT jack and the GROUND jack on the rear panel.
3	Fans	The Fans on the rear panel maintain the air flow to cool down the tester. CAUTION: When installing equipment, make sure not to cover the fans and have it on a proper ventilated area.
4	Appliance Inlet / Fuse holder / Power Switch	Use supplied cord set to connect the MegaPulse D5-PF tester to an appropriate source of supply. Fuse holder provides access for Fuse replacement, and the Power Switch is used to turn the tester ON and OFF.
5	TestMinder	Allows the communication between the tester and computer interface; a RS-232 to USB.
6	Interlock Switch	Emergency Stop Close: Enables the tester buttons for operation. Open: Stops any process in the tester and disables the buttons. The TRIGGER and CHARGE Indicators will be blinking
7	Fuse replacement warning / Rating of power supply	Specifies replacement fuse and required supply voltage.

Table 2. Control, Indicators, Connectors – MegaPulse D5-PF Rear Panel

General High Voltage Electrical Diagram

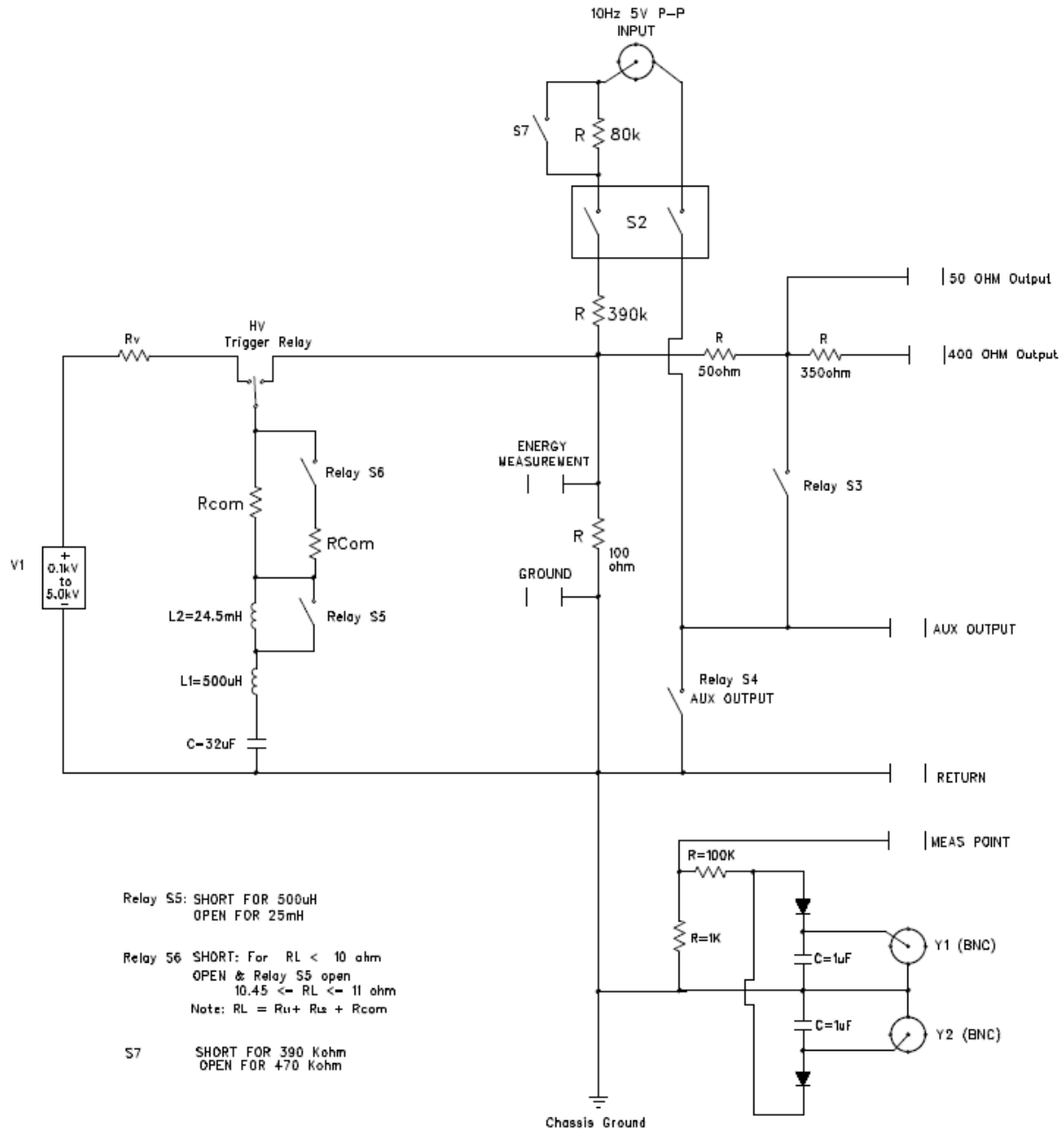

Figure 3. General High Voltage Electrical Diagram– MegaPulse D5-PF

Section 4

Operating Instructions

The D5-PF Medical Defibrillation tester consists of two parts; the pulse generation portion and the measurement portion. Please refer to the general electric circuit shown in Figure 3 to show the function of the D5-PF.

The following procedure will explain how to generate a high voltage pulse with the MegaPulse unit.

External Interlock

The external interlock is a two-position terminal block located on the rear panel. When the External Interlock is open:

- TRIGGER and CHARGE lights will be blinking.
- The front keyboard will be disabled.
- If the unit is connected to a computer with the TestMinder software, the interlock status will be shown on the computer, condition that will also disable polarity changes, charge, and trigger conditions.

When the Interlock is closed, it enables all normal operations of the MegaPulse D5-PF features.

Front Keyboard and Voltage Knob Enable

If the MegaPulse D5-PF tester has disabled the keyboard or Voltage Knob, it is possible to enable them by using the next keyboard sequence:

1. Turn OFF the MegaPulse P tester.
2. Press and hold the **TRIGGER** and **NOR-REV** buttons.
3. Turn ON the MegaPulse tester.
4. Wait until the display shows rESE.
5. Release the TRIGGER and NOR-REV buttons.

Discharging Residual Voltage

Note that the Voltage meter may indicate that some residual voltage is present on the main storage capacitor, even when the MegaPulse tester is first turned ON. This is due to inherent charging of the internal capacitors. The following procedure will explain how to discharge a remaining voltage stored on the main internal capacitor.

CAUTION

High voltage generated by the MegaPulse tester is exposed during this test. A risk of shock exists. Exercise care when using the MegaPulse unit.

1. Turn the rear-panel Power Switch OFF.
2. Set AUX OUTPUT switch to "Return" position.
3. Set S3 switch to "Open" position.
4. If the MegaPulse includes option 100X, install the 100X jumper on the rear panel.
5. If the MegaPulse includes option 34, set the Trigger time switch to 200mS, install the 50k ohm jumper on the front panel.

6. Disconnect the high voltage cables from the outputs connectors (50 ohm, 400 ohm, Aux Output, Energy Measurement point and 50K ohm “If included”).
7. Turn the rear-panel Power Switch ON.
8. Press the red **TRIGGER** button to discharge the main capacitor into the internal resistor of the MegaPulse unit.
9. Turn the rear-panel Power Switch OFF.

Polarity Pulse Selection

NOTE

If the red Trigger light is lit or more than 200V remains on the internal capacitor, the polarity pulse selection will be automatically blocked for safety reasons.

1. Turn the rear-panel Power Switch ON. Positive polarity always is set by default after the unit is turned ON.
2. Press the POLARITY switch button to toggle between positive and negative.

Voltage Set Point Adjustment

NOTE

If the front display shows the word “Off” when trying the adjustment, it means the front Voltage knob has been disabled by the Testminder software. See section “Front Keyboard and Voltage Knob Enable”

To adjust the Voltage Set Point:

1. Press the VOLTAGE Adjust knob one time to enable the adjustment mode, digits for thousands and hundreds will start blinking for a few seconds.
2. While the digits are still blinking, turn the VOLTAGE Adjust knob, clockwise or counterclockwise, to change the value of the blinking digits.
3. While digits are still blinking, press the VOLTAGE Adjust knob again and the tens and unit digits will start blinking for a few seconds.
4. While the digits are blinking, turn the VOLTAGE Adjust knob, clockwise or counterclockwise, to change the value of the blinking digits.
5. After a few seconds without any change on the VOLTAGE Adjust knob, the desired output voltage will be set.

Charge and Trigger a Pulse

The following procedure will explain how to generate a high voltage pulse with the MegaPulse unit. The MegaPulse D5-PF is capable to maintain a specific voltage charge selected by the Voltage Set Point.

CAUTION

High voltage generated by the MegaPulse tester is exposed during this test. A risk of shock exists. Exercise care when using the MegaPulse unit.

1. Confirm the Voltage Set Point by pressing the VOLTAGE Adjust Knob, the current setting will blink for a few seconds on the front meter.
2. If a different Voltage Set Point is needed it, refer to section “Voltage Set Point Adjustment.”
3. Set the front panel switches depending on the type of test needed. Follow the front panel directions or see Figure 3 for the electrical diagram.

4. Push the yellow CHARGE button to start charging the internal high voltage capacitor and wait until the front meter reaches value set on Steps 1 or 2. Verify that the red TRIGGER indicator is now lit.
5. Once the desired voltage is reached, press the red **TRIGGER** button to deliver the high voltage pulse (be sure not to touch the output and return leads when pressing the trigger switch).
6. Turn the rear-panel Power Switch OFF.

Pulse Verification Procedure

The following procedure will verify that the high voltage pulse is properly generated by the D5-PF tester. We recommend that this procedure be conducted periodically to ensure proper operation of the tester. The following items are needed to conduct this procedure:

- High voltage oscilloscope probe (1000:1)
- Digital Oscilloscope

Always ensure that the measuring instruments are rated for the voltage and frequency response involved. A digital oscilloscope or probe with a low frequency response will result in erroneous readings that could be misread.

CAUTION

High voltage generated by the MegaPulse tester is exposed during this test. A risk of shock exists. Exercise care when using the MegaPulse tester.

1. Turn the rear-panel Power Switch OFF.
2. Set Aux output switch to "Return" position.
3. Set S3 to "Open" position.
4. If the MegaPulse includes option 100X, install the 100X jumper on the rear panel.
5. If the MegaPulse includes option 34, set the Trigger time switch to 200mS, install the 50k ohm jumper on the front panel.
6. Disconnect all high voltage cables from the outputs (50 ohm, 400 ohm, Energy Measurement Point and 50k ohm if included).
7. Turn the rear-panel Power Switch ON. If residual voltage is shown on LED display:
 - a. Press the red **TRIGGER** button to discharge the main capacitor into the internal resistor of the MegaPulse unit.
8. Set the Voltage Set Point to 5000V, see section "Voltage Set Point Adjustment."
9. Select the internal inductance of 500uH by using the front panel switch "INDUCTOR."
10. Plug the high voltage test lead (black) into the Return jack, located on the front panel.
11. Plug the high voltage test lead (red) into the 50 ohm jack, located on the front panel.
12. Connect the ends of the test leads to the measuring instrument. See Figure 4 for an example.
13. Set the next capturing setting on the digital oscilloscope to capture the high voltage pulse:
 - a. Vertical Scale = 1.00KV / div.
 - b. Horizontal Scale = 500uS / div
 - c. Trigger Level = + 1kV
 - d. Slope transition "Low to High."
 - e. Set "High Frequency Reject" mode.
 - f. Set "Single Pulse" capture mode.
14. Press the Charge button and wait until voltage reaches 5000V.
15. Press the Trigger button to deliver the pulse (be sure not to touch the output and return leads when pressing the trigger switch).
16. Verify the amplitude of the positive pulse captured on the digital oscilloscope:
 - a. V_{peak} about 4.72KV, see figure 5 (When selected inductor is 500uH).
 - b. V_{peak} about 3.88KV, see figure 6 (When selected inductor is 25mH).
17. Select a negative pulse by pressing the polarity button, and verify the yellow REV indicator is lit.
18. Change the capturing setting on the digital oscilloscope to capture the negative pulse:

- a. Trigger Level = -1kV.
 - b. Slope transition "High to Low"
19. Charge and Trigger the pulse at 5000V.
 - a. Push the yellow **CHARGE** button to start charging the internal high voltage capacitor.
 - b. Once the desired voltage is reached, press the red TRIGGER button to deliver the pulse (be sure not to touch the output and return leads when pressing the trigger switch).
20. Verify the amplitude of the negative pulse captured on the digital oscilloscope:
 - a. Vpeak about - 4.72KV (When inductor selected is 500uH).
 - b. Vpeak about - 3.88KV (When inductor selected is 25mH).

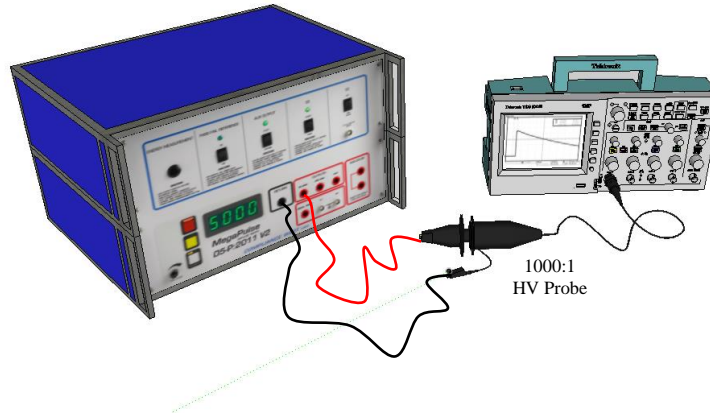

Figure 4. Checkout Pulse Setup

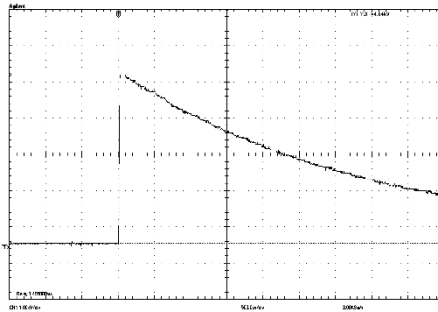

Figure 5. Vpeak = 4.72kV with 500uH inductor

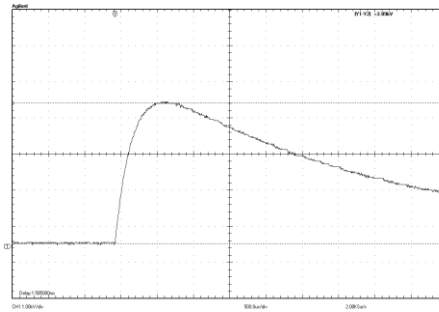

Figure 6. Vpeak = 3.88kV with 25mH inductor

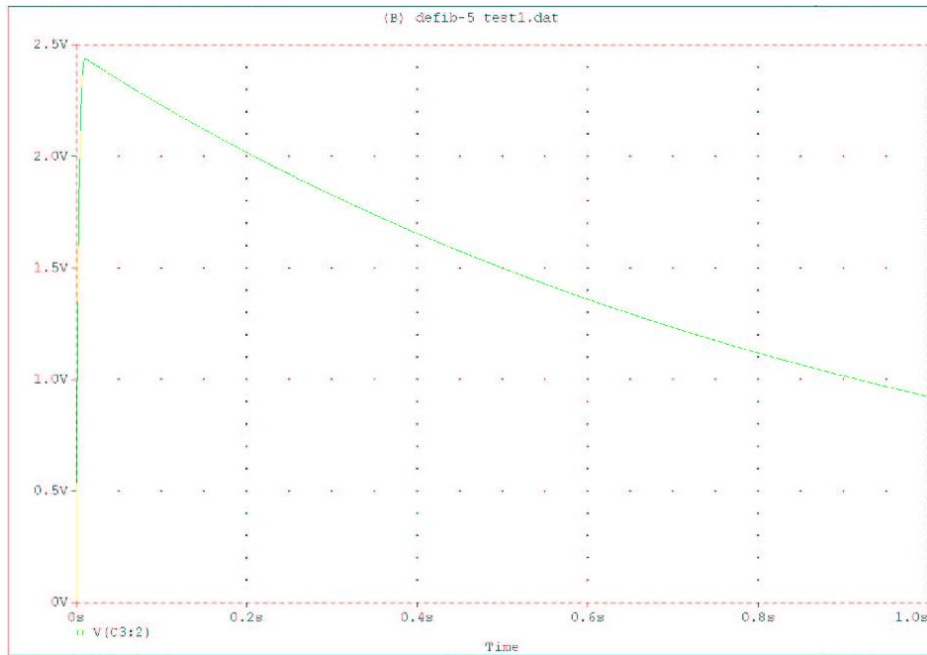

Figure 7. Y1 Y2 Test Output

Energy Measurement

Many medical equipment standards require energy measurements to be taken during surge testing. The D5-PF allows calculation of these measurements in two different ways; by using the automatic energy measurement system included in the tester or by connecting an external high voltage acquisition system to capture the pulse using the rear panel receptacles and manually calculating the energy using the formula shown in Figure 8.

$$E = \int_0^T p(t) dt = \frac{1}{R} \int_0^T s^2(t) dt$$

Figure 8. Formula to Calculate Energy

Where:

- “s” is the voltage pulse captured with a high voltage acquisition system *.
- “dt” is the difference on time between samples of the acquisition system.
- “T” is the total duration of the pulse.
- “R” is the resistance value where the pulse is applied **.
- “E” is the energy in joules.

* The high voltage acquisition system can be a 1000:1 oscilloscope probe connected to a digital oscilloscope capable of executing advanced mathematical functions. The oscilloscope would then be used to calculate the energy by calculating the area under the curve.

** The D5-PF has been designed with a resistor value R of $100\Omega \pm 1\%$, which will result in a value between 99 and 101 Ω . We recommend using a value of 100 Ω during energy calculations as a good approximation of the value for “R” over the test period.

Energy Measurement using System Included on D5-PF

The MegaPulse D5-PF tester is equipped with an internal high voltage pulse acquisition system connected directly to the internal 100 ohm resistor. This system automatically calculates the energy for each single pulse delivered.

Note 1: To calculate the energy, this automated measurement system uses the mathematical formula showed on figure 8, where $R = 100\Omega$.

Note 2: This automatic option only operates when the D5-PF tester has the following settings:

- AUX OUTPUT switch is in the RETURN position
- S3 switch is in the OPEN position
- INDUCTOR switch is for 25mH
- Voltage Set point adjusted between 3500V - 5000V

To perform the automatic energy measurement follows the next steps:

1. Select the desired polarity.
2. Charge and Trigger the D5-PF between 3500V - 5000V
3. Press the Energy Measurement Button. The front display will blink for a few seconds showing the energy measurement in joules from the last pulse. If the display shows the word “none”, it means the last pulse was not captured.

Criteria to validate the energy results:

1. Measure the energy with open circuit (No DUT connected to the D5-PF)
2. Measure the energy with the DUT connected on the output.
3. Subtract the two energies measured on steps 1 and 2, and the difference on these two readings must not exceed the % established on the standard that the user is following.

Energy Measurement with an External Acquisition System

The MegaPulse D5-PF tester is equipped with two high voltage connectors located on the rear panel to have access directly to the 100 Ω resistor, allowing energy measurements with an external high voltage acquisition system. The acquisition system must be capable of executing the advanced mathematical formula shown on figure 8. Figure 9 shows an example of how connect the external acquisition system.

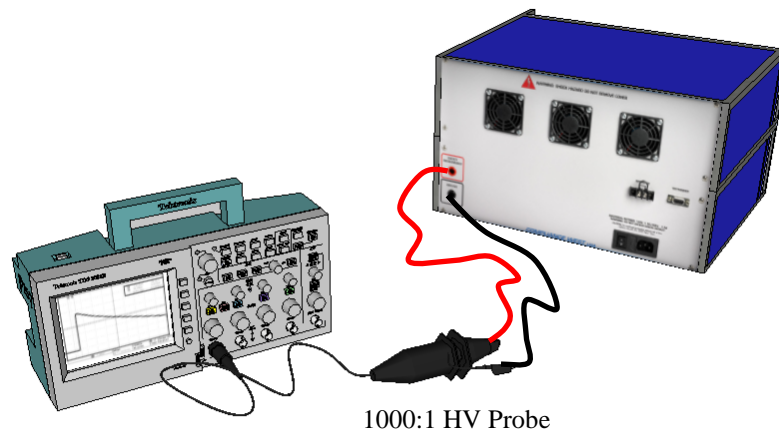

Figure 9. Energy Measurement with an External Acquisition System

Measurement Terminals Y1 and Y2

There are two BNC jacks on the front panel of the D5-PF, labeled Y1 and Y2. These are used to verify that the Applied Part or Chassis of the Equipment Under Test does not exceed 1 Volt peak in accordance with IEC/EN/UL 60601-1. A marginally failing product will cause the voltage on the oscilloscope to rise to 1 Volt (ref. 60101-1 clause 17h). Note that this voltage does not have the same wave shape as the defibrillation pulse. The measurement point has a voltage rise time constant of 2 mS (derived empirically). The decay time of the measurement point is driven by the impedance of the oscilloscope, which is typically 1 M Ω . In this case, the decay time would have a time constant of 1 second. When testing using the math function, the time base should be set at 500mS/division. If a smaller time base is used, there could be transient noise on the waveform.

Pass Fail Reference Built in

The Pass Fail Reference Built in circuit is designed to allow the user perform a quick check test of the Y1-Y2 measurement system of the D5-PF tester.

To perform a quick test using the Pass Fail Reference Build in follow the next steps:

1. Set the Pass Fail switch to the ON position.
2. Set Aux output switch to "Return" position.

3. Set S3 to “Open” position.
4. Select Inductor switch to the 500uH.
5. Only if option 100X is included on the D5-PF tester, install the 100X jumper on the rear panel.
6. Only if option 34 is included on the D5-PF tester:
 - a. set the time switch to 200mS
 - b. Install the 50kΩ jumper on the front panel. Select
7. Using two BNC cables, connect the D5-PF to an oscilloscope as follows:
 - a. Y1 to CH1
 - b. Y2 to CH2
8. Set the oscilloscope with the next parameters:
 - a. Set the Math function A-B on the oscilloscope.
 - b. Set channel 1 and 2 at 1X with 500mV.
 - c. Set the trigger on channel 1 at 100mV.
 - d. Set the time at 500ms.
 - e. Activate the Math function and turn off channel 1 and 2
9. Verify or adjust the Voltage Set Point to 5000V.
10. Press the CHARGE button to start charging the internal high voltage capacitor,
11. Once the desired voltage is reached, press the red **TRIGGER** button to deliver the high voltage pulse and to capture the waveform in the oscilloscope.
12. The oscilloscope should display a waveform similar to Figure 10, with a peak value of approximately 1 volt.

Note: If on the oscilloscope the horizontal time is set less than 500mS, it may capture transient noise because the internal mechanical relays are switching the high voltage, but the correct criteria for Y1-Y2 signal must be on the 500mS scale.

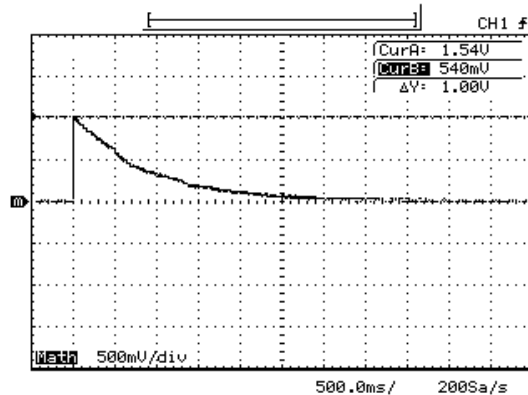

Figure 10. Y1-Y2 Waveform using a Defib-5P Pass/Fail Reference

Section 5

Testing with the D5-PF

To perform actual testing, the D5-PF should be connected to the EUT as shown in the standard which the EUT is being tested to. See figures 11 and 12 are examples of the MegaPulse D5-PF connections for testing parameters of IEC60601. They can be used as a key for the inputs and outputs of the MegaPulse D5-PF. Note the actual connections on the front panel of the D5-PF have been added to Figure 50 of IEC 601 for illustrative purposes. Make sure to confirm your specific circuit connections based on the standard the EUT is being tested to verify your test connections are correct.

Page 199 bis

Add the following new figures 50 and 51:

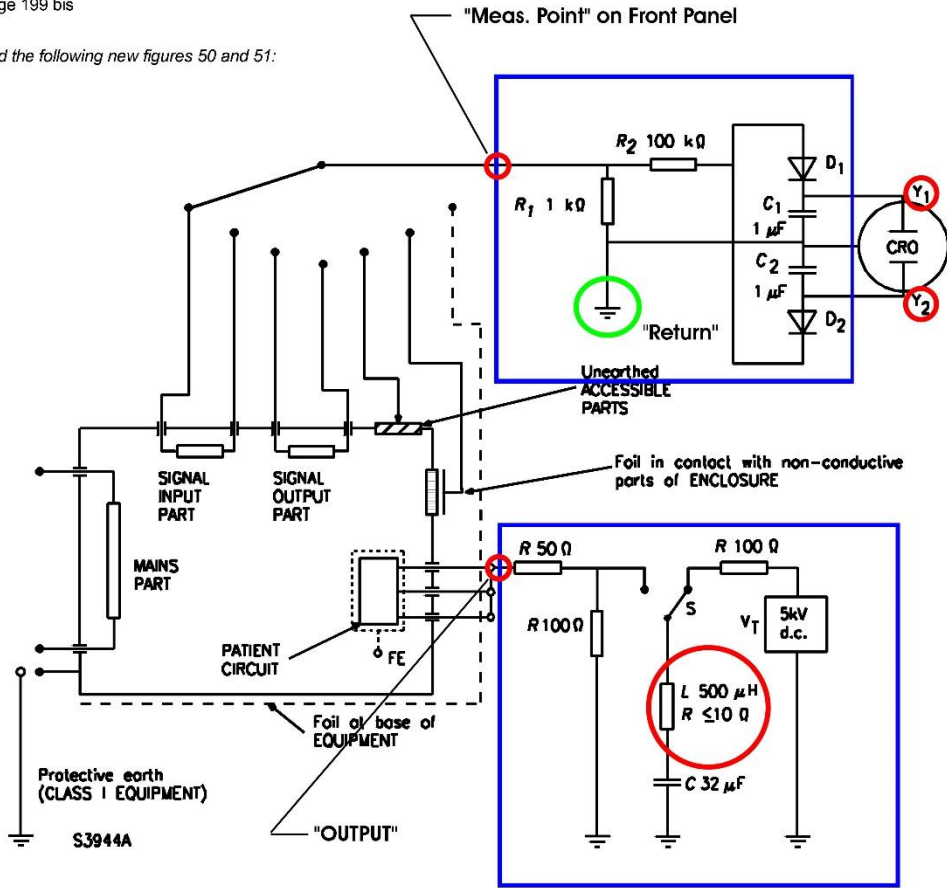
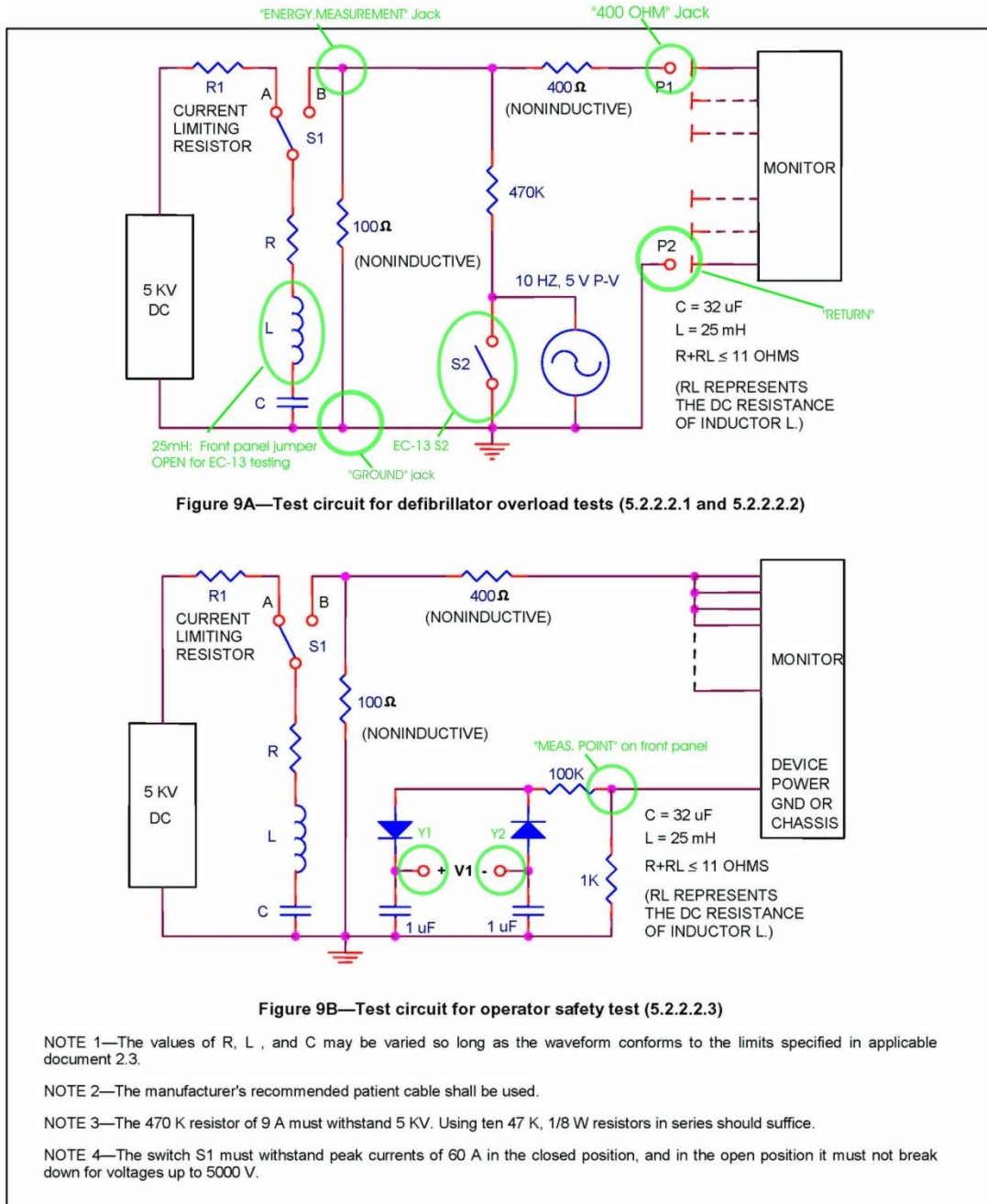

Figure 50 – Application of test voltage to bridged PATIENT CONNECTIONS for DEFIBRILLATION-PROOF APPLIED PARTS (see subclause 17 "h))

Figure 11. Example of D5-PF Connections on Figure 50 of IEC60601



NOTE: All D5-PF meet the specifications of IEC 60601-2-27 ed 3.0 where a 390KΩ resistor replaced the 470KΩ.

Figure 12. Example of D5-PF Connections on Figures 9A and 9B of IEC60601

Section 6

Options

This section contains a list of available options for D5-PF.

Option Name	Description
34	Incorporates a circuit for Invasive Blood Pressure test (IEC 60601-2-34 Issue 2)
100X	HV jumper to disconnect the internal 100ohm resistor and use external Energy measurement devices like Fluke 7000DP and 7010.
MPxxx	Different Line voltages, replace on the part number xxx for 100, 110, 220, 230 or 240 depending the line voltage. (120V for standard configuration).
SG	Built in Sine Wave Generator 22Vp-p (Max).
GVAC	Vacuum trigger relay (20sec. duty cycle only)

Circuit for Invasive Blood Pressure test (IEC 60601-2-34 Issue 2)

This option gives you the convenience to select the discharge resistor 100ohm or 100kohm with a high voltage jumper located in the front panel; it also has an additional output impedance of 50kohm and switch to select trigger duration of 200ms or 20 seconds, this resistance values are need when testing to IEC 60601-2-34. Ed. 2.0, If testing IEC 60601-2-34. Ed. 3.0 no need of adding option 34.

100X

The 100X Option is offered as a separate upgrade to the unit. The Purpose of the 100X Option is to disconnect the internal 100Ω resistor and allow the user to connect an external load for energy measurement purposes.

To connect or disconnect the internal 100Ω resistor, the D5-PF with option 100X is equipped with two high voltage red connectors located on the rear panel. These two connectors are labeled with:

SHORT FOR INTERNAL LOAD: Internal 100Ω load connected.

OPEN FOR EXTERNAL LOAD: Internal 100Ω is disconnected (Note: Use an external load at the Energy Measurement and Ground connectors).

WARNING:

If the Jumper is OPEN FOR EXTERNAL LOAD and the external load is not connected the unit will not discharge properly. The external load should not be less than 95Ω or more than 1000Ω.

To connect an external load for energy measurement purposes, follow the next steps:

1. Turn OFF the D5-PF tester.
2. Connect the 100X Jumper in the rear panel for internal load.
3. Unplug all the cables from the outputs.
4. Set Aux output switch to "Return" position.
5. Set S3 to "Open" position.
6. Set the inductor switch to 25 mH.
7. Only if the option 34 is included on the D5-P:2011, set the Trigger time switch to 200mS and, install the 50k ohm jumper on the front panel. Select the internal inductance of
8. Turn ON the D5-PF tester.
9. Press the TRIGGER button to discharge the tester and make sure the front meter display reads a safe low voltage.
10. Turn OFF the MegaPulse D5-PF.
11. Remove the 100X Jumper in the rear panel for external load.
12. Connect an external load at the Energy Measurement and Ground connectors.
13. Turn ON the MegaPulse D5-PF.
14. Tester is ready to CHARGE and TRIGGER with 100X Option.

To return the D5-PF tester to normal operation condition, follow the next steps:

1. Turn OFF the D5-PF tester.
2. Remove the load connected to Energy Measurement and Ground connectors.
3. Connect the 100X Jumper in the rear panel for internal load.
4. Turn ON the D5-PF tester.
5. Tester is ready to CHARGE and TRIGGER.
6. Turn OFF the D5-PF tester.

Sine Wave Generator

The Sine Wave Generator option is offered as a separate upgrade to the unit. The sine wave is adjustable and must be set up using an oscilloscope. The Sine Wave Generator signal characteristics are defined as follows:

- Frequency = 10Hz
- The sine wave is adjustable from 200mVp-p to 22Vp-p
- Coarse and Fine adjustments for the peak voltage
- The BNC is an output to monitor on an oscilloscope

A 1M Ω impedance input on the oscilloscope needs to be used to measure the sine waveform.

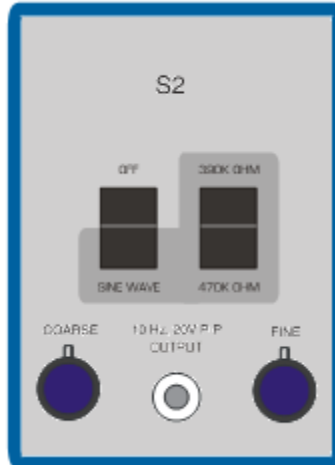

Figure 13. Sine Wave Generator option

To operate the Sine Wave Generator option follows the next steps:

1. Put the S2 switch in the **SINE WAVE** position.
2. Attach the 10 Hz sine wave BNC output to an oscilloscope with a $1M\Omega$ impedance input.
3. Adjust the sine wave amplitude using the coarse and fine adjustments.
4. Put the S2 switch in the **OFF** position.
5. Charge and Trigger the pulse per the directions in the user manual.
6. After the pulse, put the S2 switch in the **SINE WAVE** position to apply the sine wave.

Vacuum Trigger Relay

WARNING:

For this option never exceed 20-second duty cycle

This is high voltage filled with gas of sulfur hexafluoride type SF₆, because of the way the gas performs during switching. SF₆ is an excellent insulator but once the switch is closed, if the relay bounces the SF₆ becomes easily ionized and carries the arc current, this makes the relay electronically bounce less and dramatically reduces contact wear.

Section 7

Maintenance and Calibration

WARNING:

THESE SERVICE INSTRUCTIONS ARE FOR USE BY QUALIFIED PERSONNEL ONLY. TO AVOID ELECTRIC SHOCK, DO NOT PERFORM ANY SERVICING OTHER THAN THAT CONTAINED IN THE OPERATING INSTRUCTIONS UNLESS YOU ARE QUALIFIED TO DO SO.

Service Information

The MegaPulse D5-PF tester is warranted to the original purchaser for a period of 1 year. This warranty does not cover problems due to misuse or neglect. Malfunctions which occur within the limits of the warranty will be corrected at no charge. Mail the instrument postpaid to the manufacturer. Dated proof of purchase is required for all in-warranty repairs. The manufacturer is also available for calibration and / or repair of instruments that are beyond their warranty period. Contact the manufacturer for a cost quotation. Ship the instrument and your remittance per the instructions given by the manufacturer.

General Maintenance

To avoid contaminating the PWB with oil from your fingers, handle it by the edges or wear gloves. If the PWB becomes contaminated, refer to the cleaning procedures given later in this section

Cleaning

CAUTION

Do not use aromatic hydrocarbons or chlorinated solvents for cleaning. These solutions will react with the plastic materials used in the instrument.

Clean the front panel and case with a mild solution of detergent and a damp sponge. Clean dust from the PWB with clean, dry, low pressure (<20 psi).

Calibration Information

The MegaPulse D5-PF has been fully calibrated at the factory in accordance to our published specifications. It is recommended that you have this instrument re-calibrated and safety check done at least once per year. The procedure consists on internal components tolerance verification and calibrating the meter reading to agree with the capacitor bank.

The Calibration procedure must be performed by qualified personnel. Contact Compliance West USA for the latest calibration procedure. Have ready the serial number of the MegaPulse D5-PF tester.

Technical Assistance

Technical Assistance from Compliance West USA is available:

Phone: (800) 748-6224

Hours: 8:00 AM - 4:00 PM Pacific Time.

Also, available on our web site at: **www.compwest.com**

Contact:

Compliance West USA
650 Gateway Center Way, Suite D
San Diego, CA., 92102
United States of America.

Phone: (619) 878-9696

FAX: (619) 794-0404