

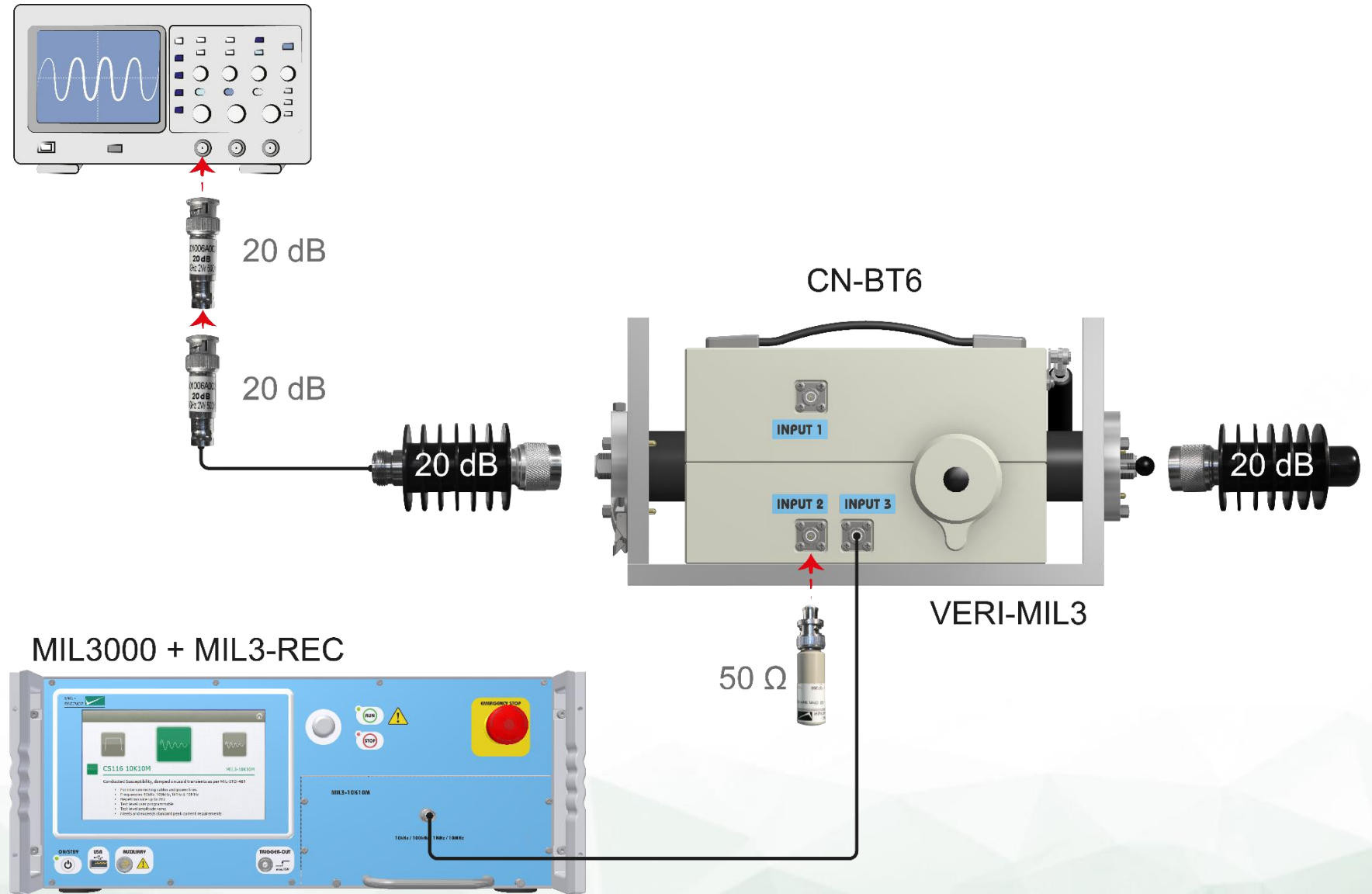

MIL3000 - calibration and test setups

Simple to setup and operate, powerful functionality

- 
- ✓ MIL-STD-461G CS 115 [calibration](#) and [test](#) setups
 - ✓ MIL-STD-461G CS 116 [calibration](#) and [test](#) setups 10 kHz – 10 MHz
 - ✓ MIL-STD-461G CS 116 [calibration](#) and [test](#) setups 30 MHz – 100 MHz
 - ✓ MIL-STD-461F CS 106 [calibration](#) and [test](#) setups
 - ✓ MIL-STD-461C CS06 [calibration and test setups](#)
 - ✓ DO-160 Section 17 [calibration](#) and [test](#) setups
 - ✓ DO-160 Section 19 (spikes) [calibration](#) and [test](#) setups



✓ VERI-MIL3 includes both calibration loads (2 x 20 dB/50 Ω) and measurement attenuators (2 x 20 dB/50 Ω)

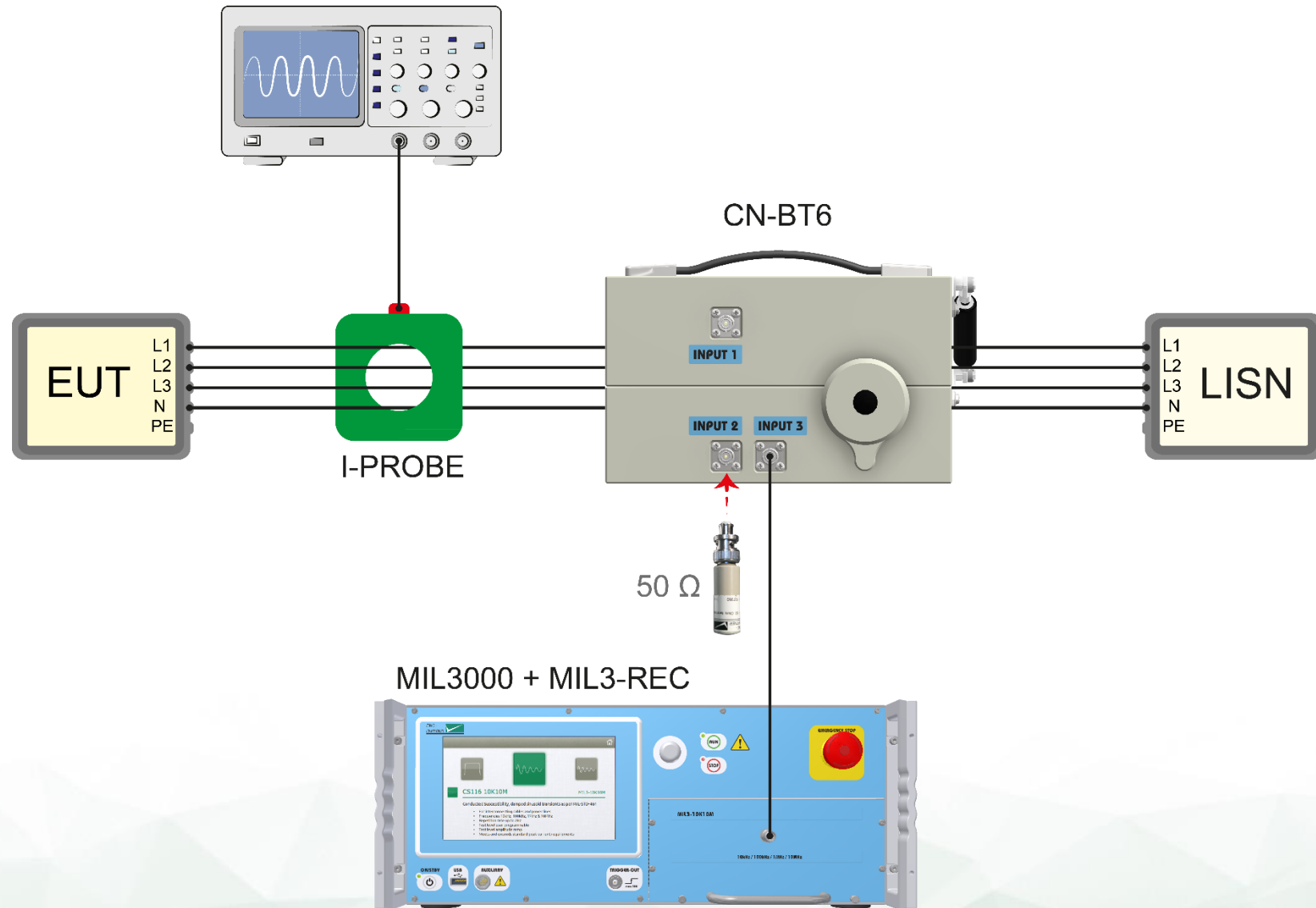

✓ I-PROBE-CS can be used

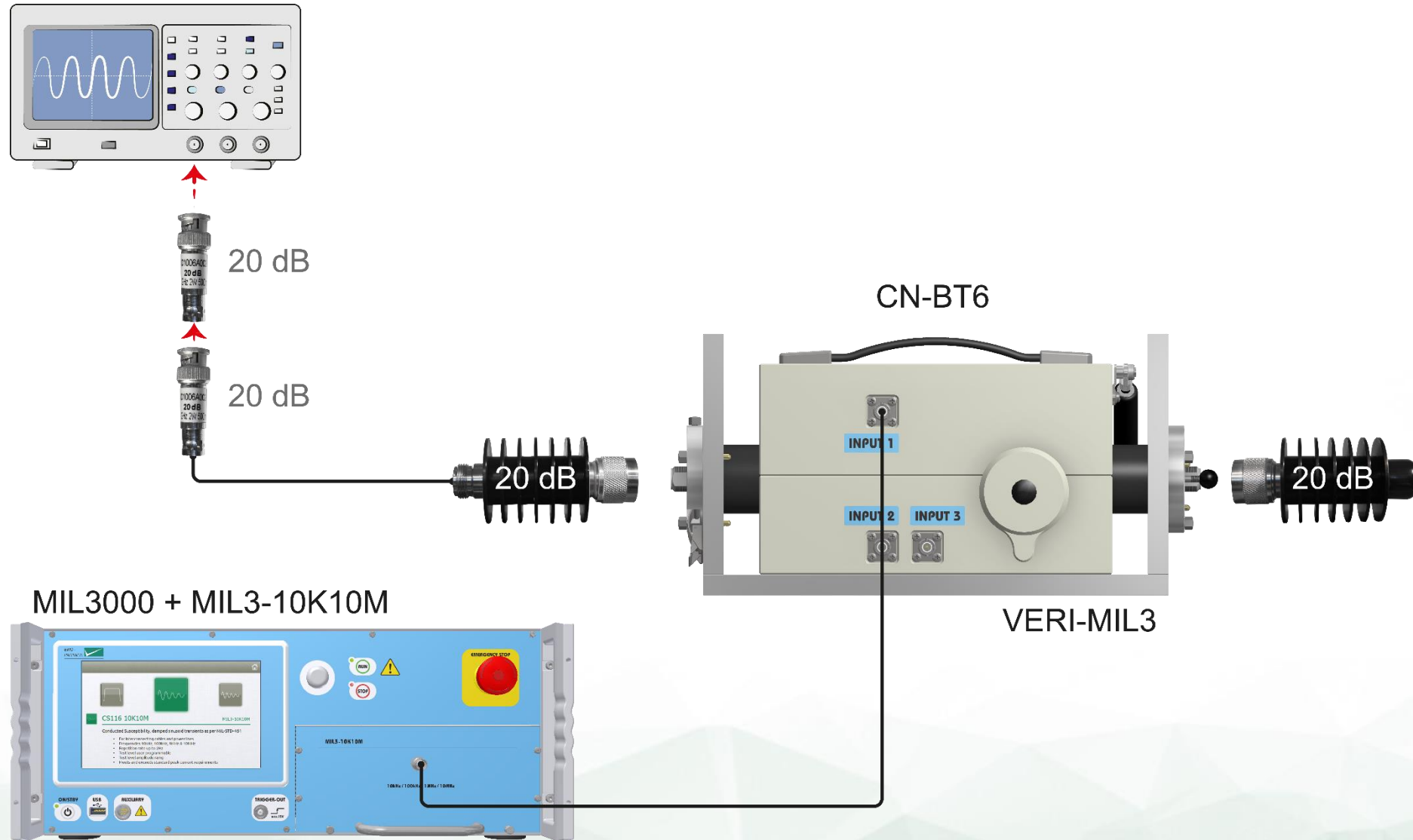

✓ VERI-MIL3 includes both calibration loads (2 x 20 dB/50 Ω) and measurement attenuators (2 x 20 dB/50 Ω)

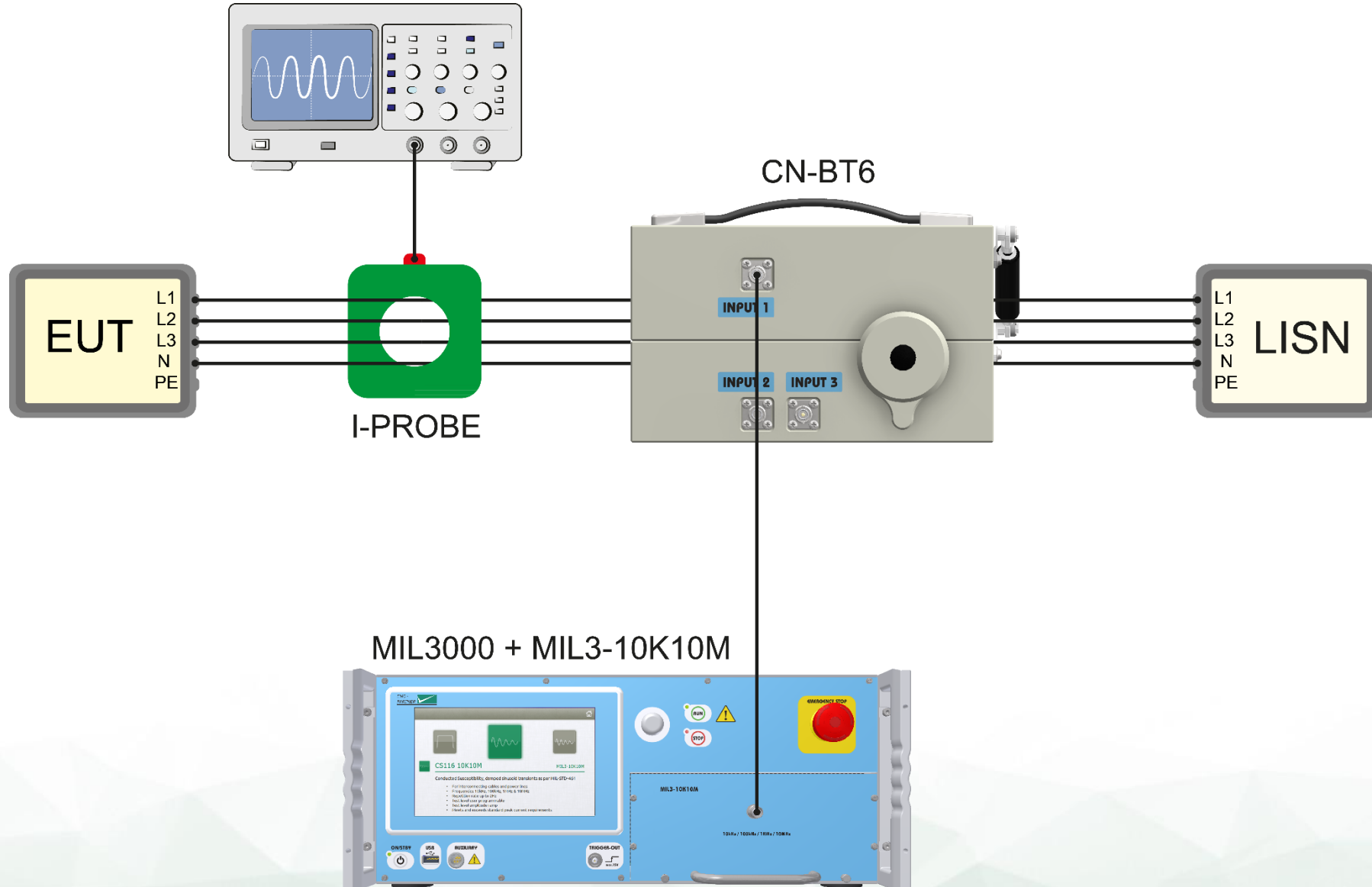

✓ I-PROBE-CS can be used

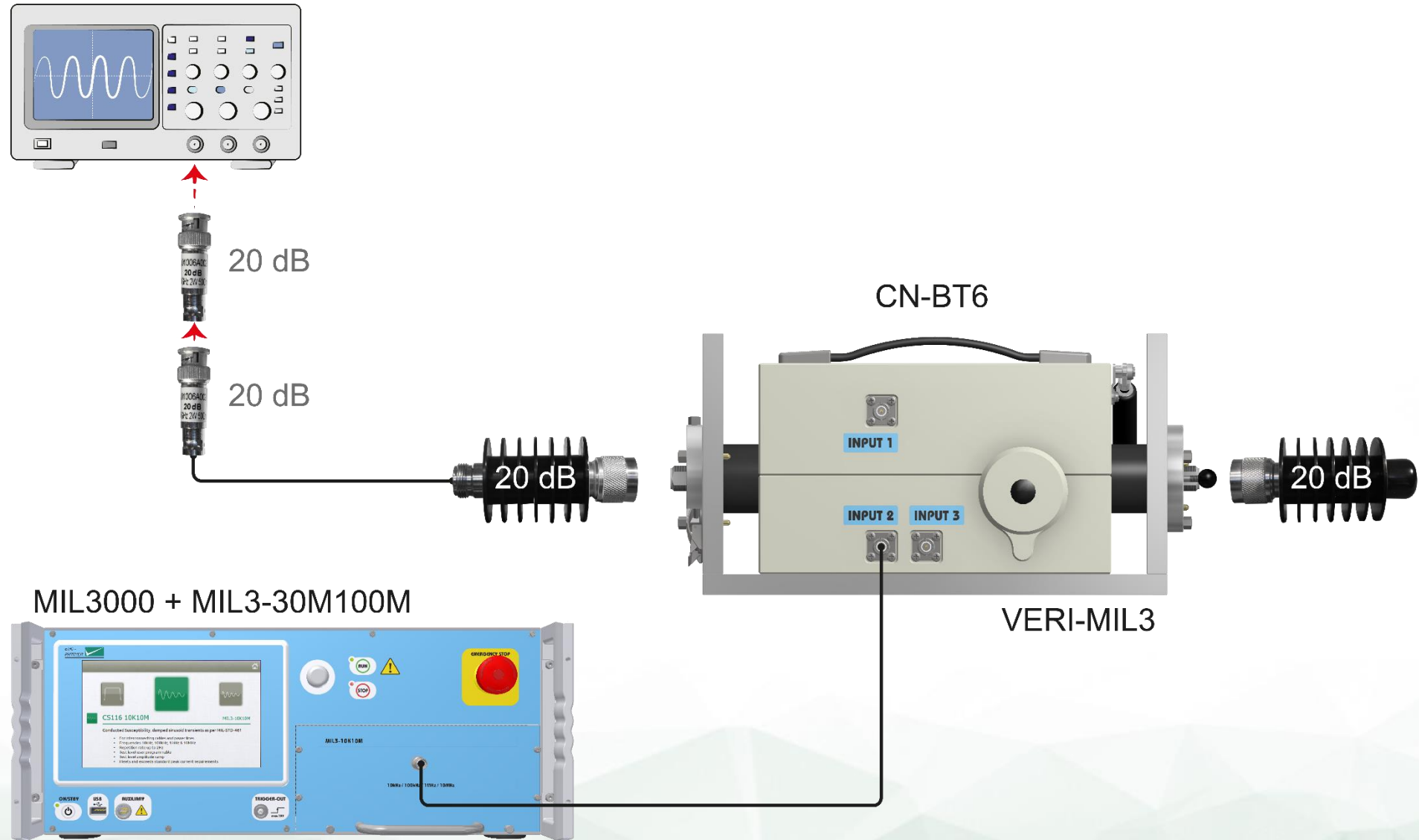

✓ VERI-MIL3 includes both calibration loads (2 x 20 dB/50 Ω) and measurement attenuators (2 x 20 dB/50 Ω)

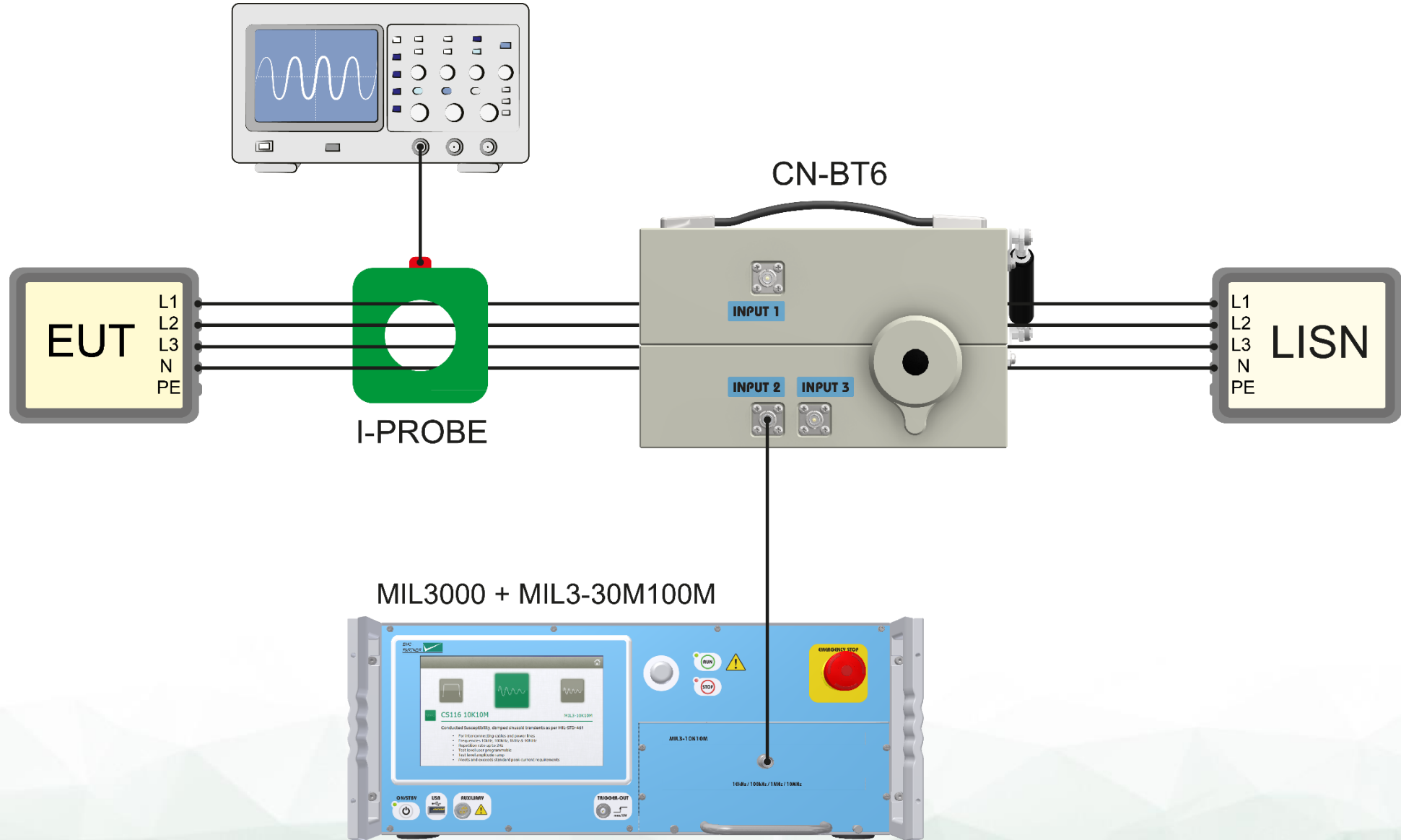

✓ I-PROBE-CS can be used

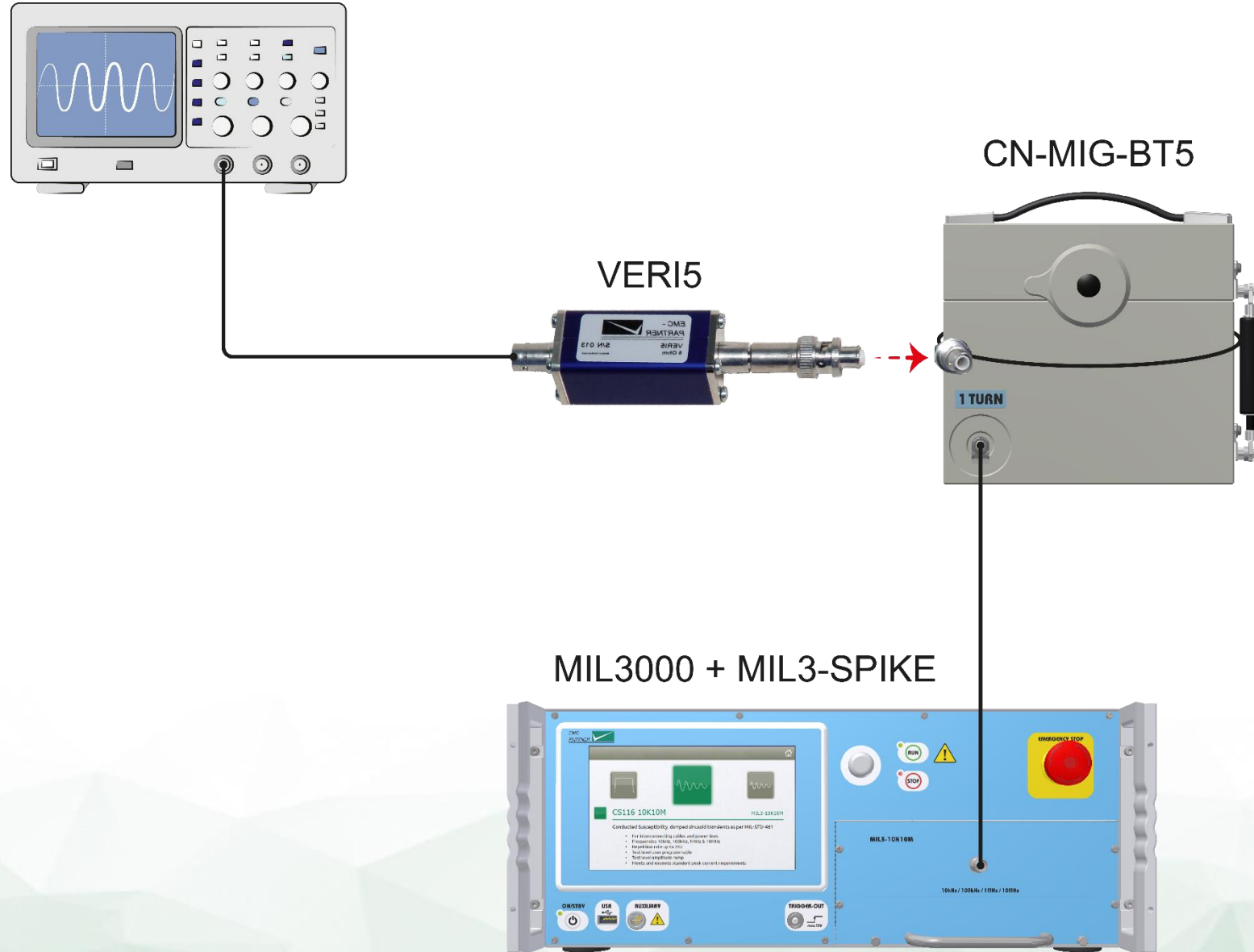

MIL3000 + MIL3-SPIKE

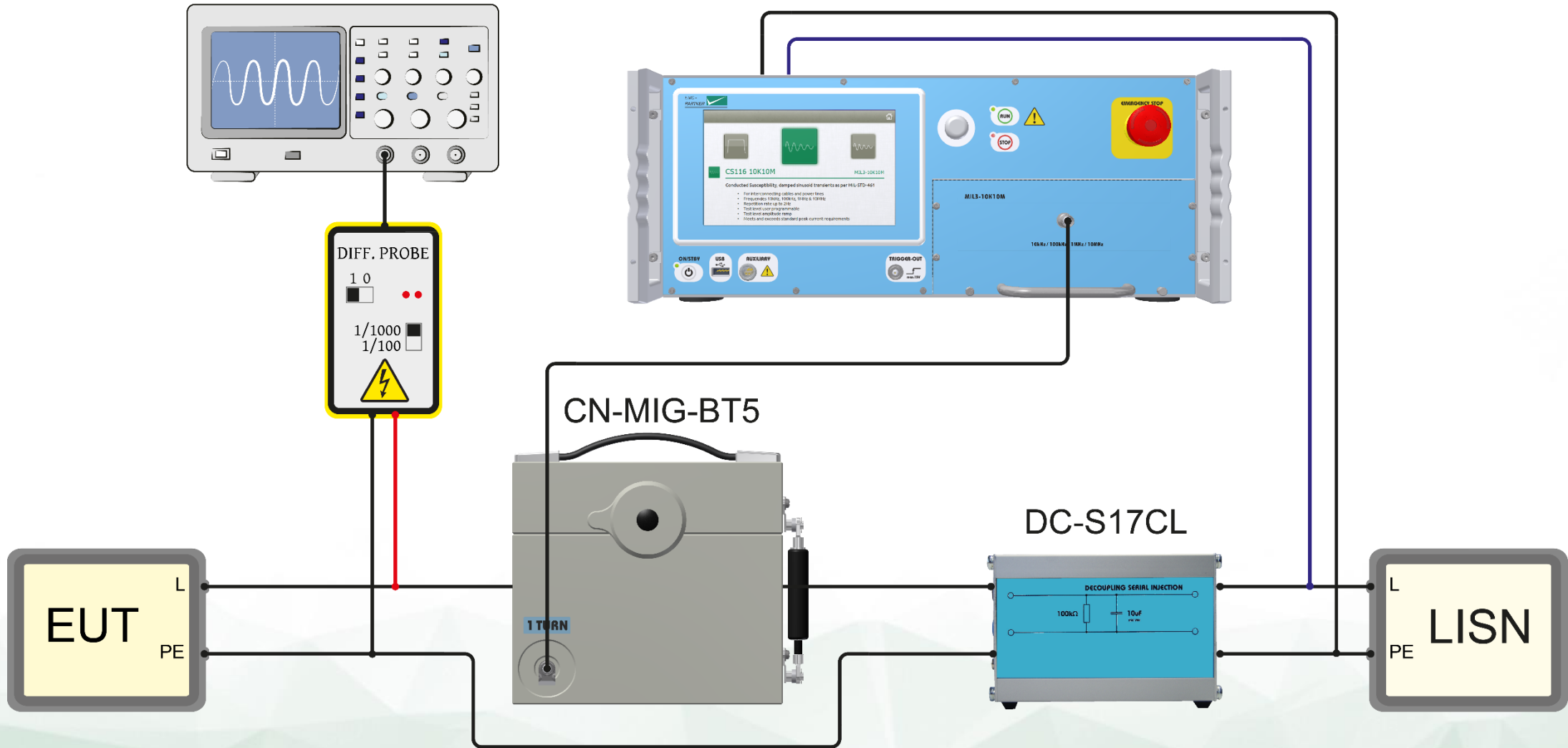

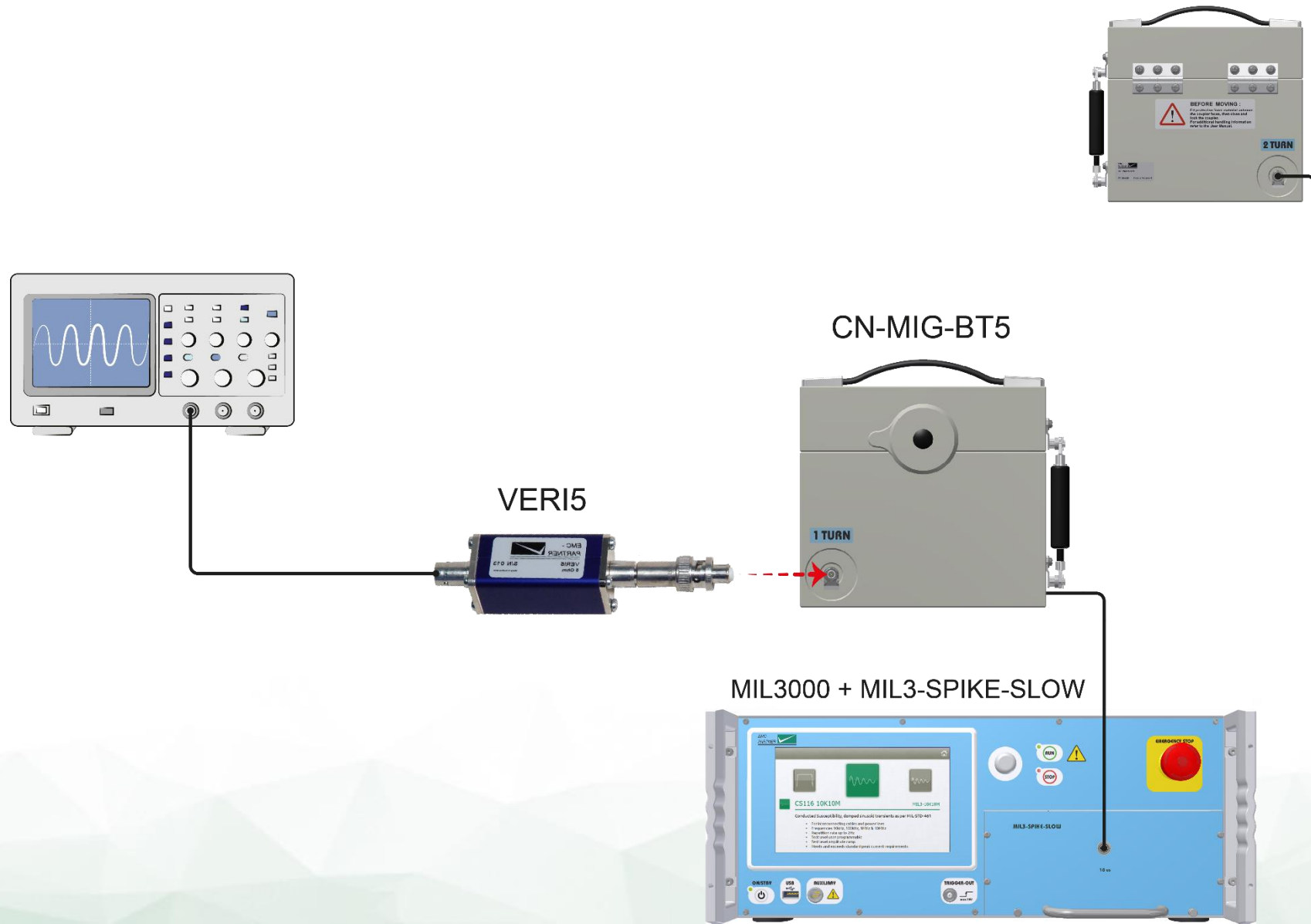

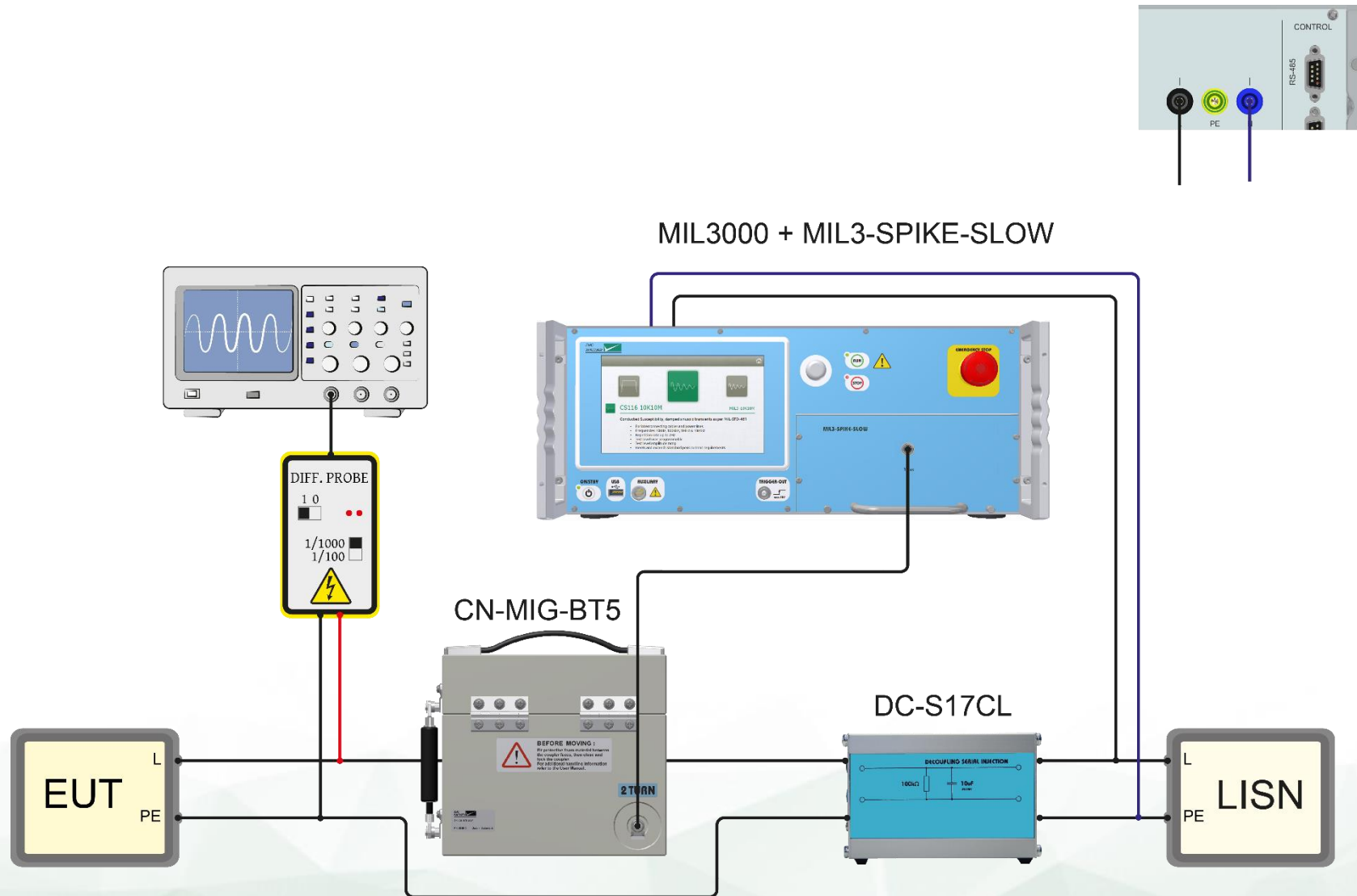

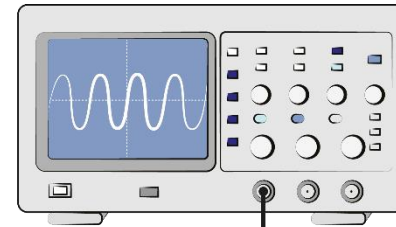

VERI5



MIL3000 + MIL3-SPIKE-SLOW

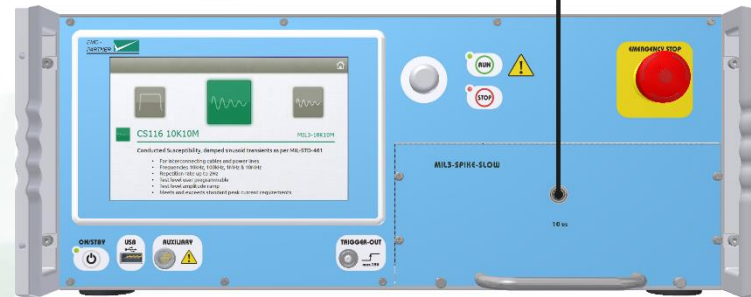

MIL3000 + MIL3-SPIKE-SLOW

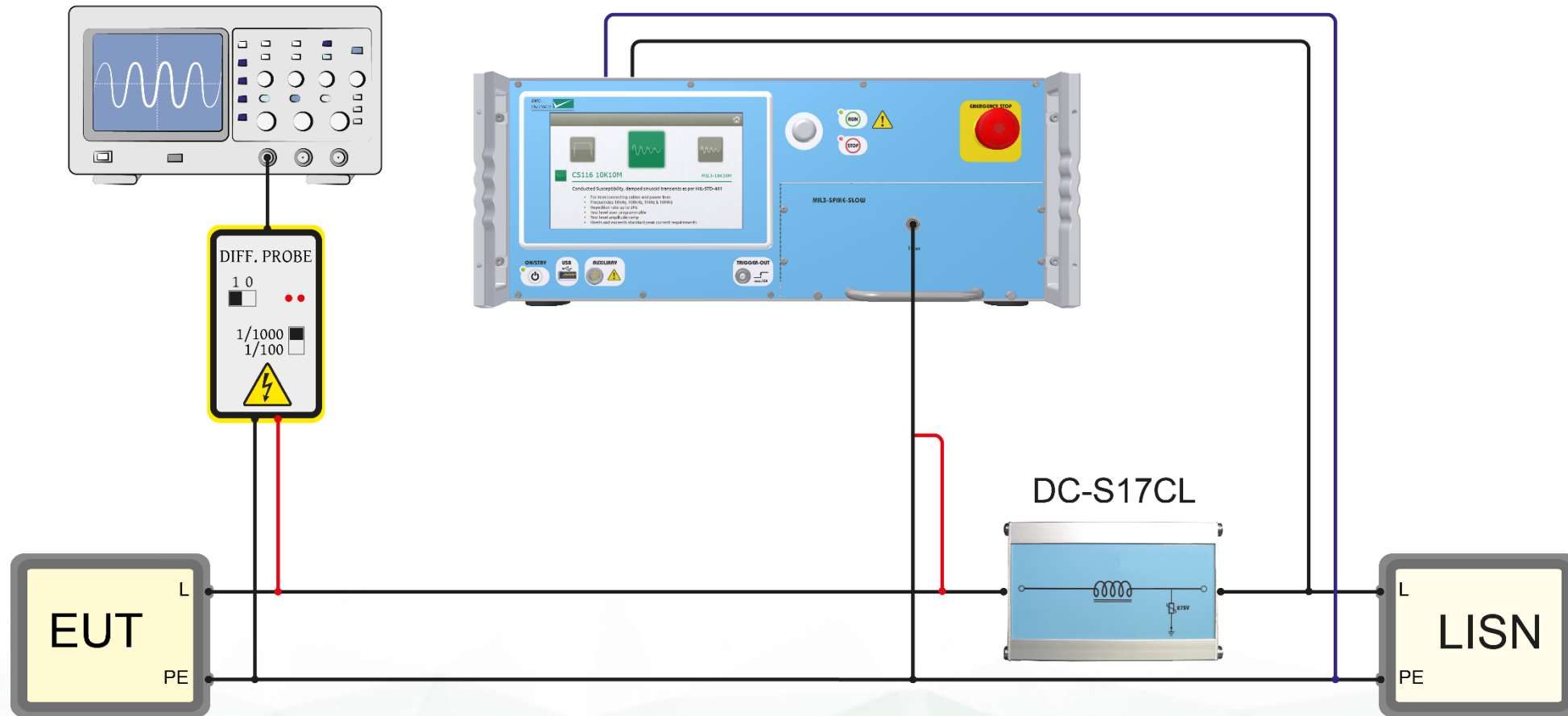

MIL3000 + MIL3-SPIKE-FAST

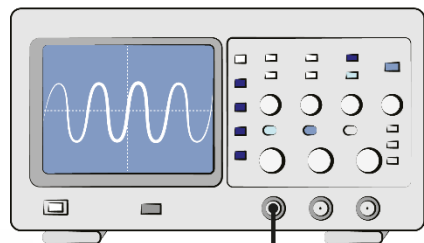
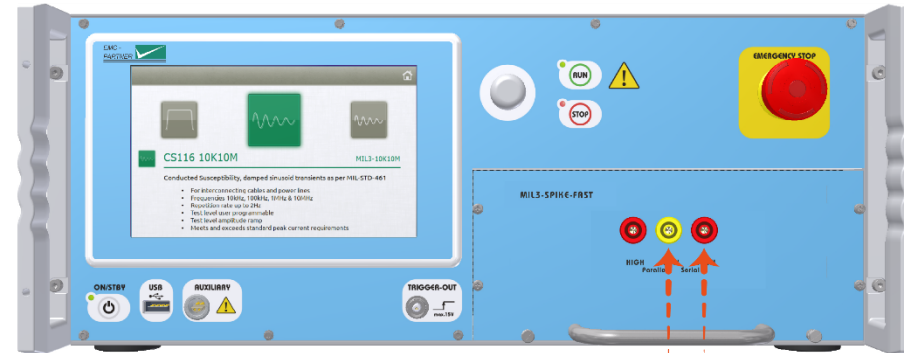

VERI5



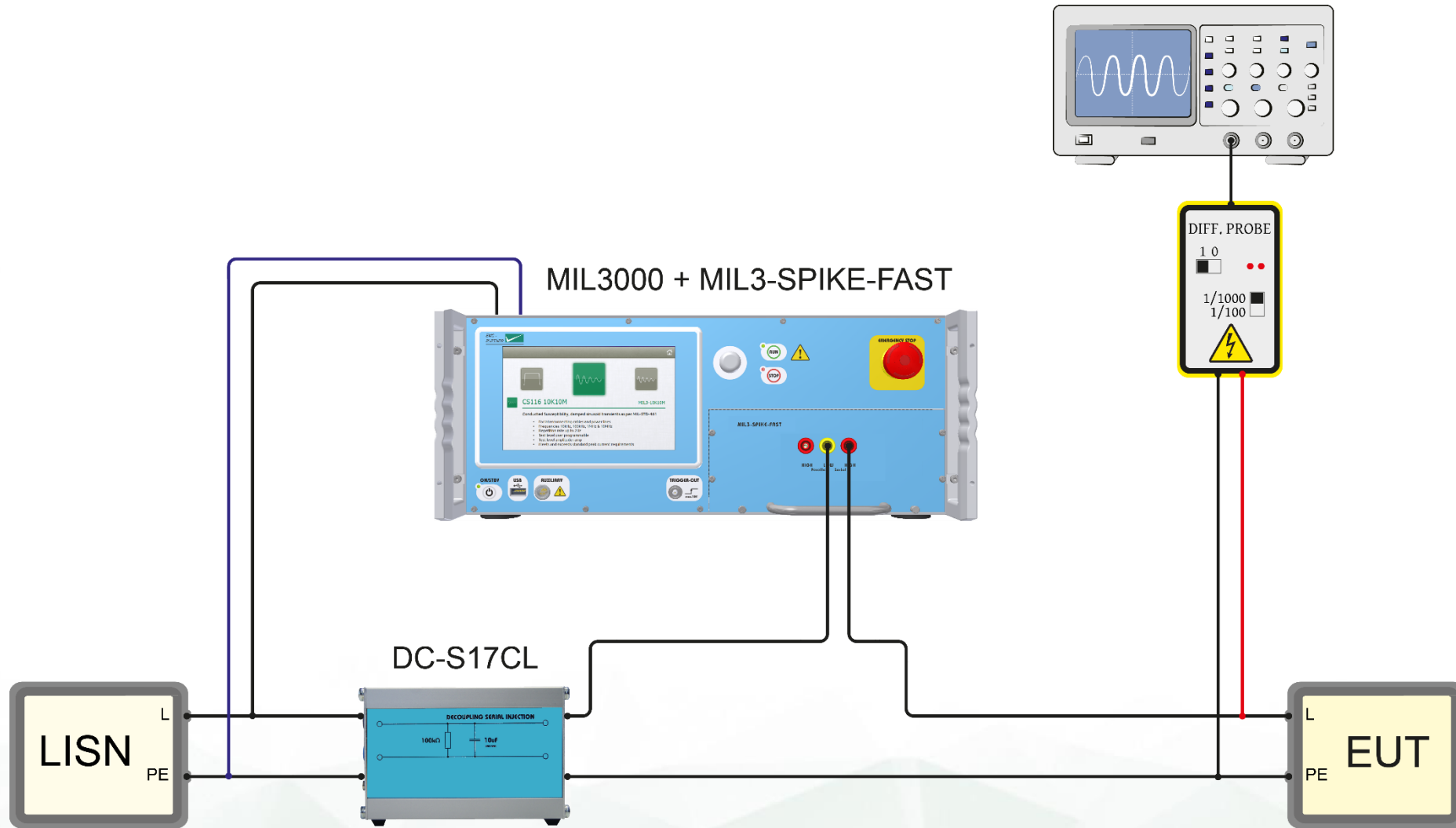

MIL3000 + MIL3-SPIKE-FAST

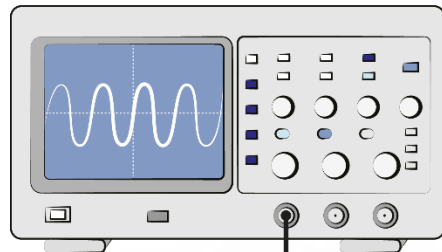
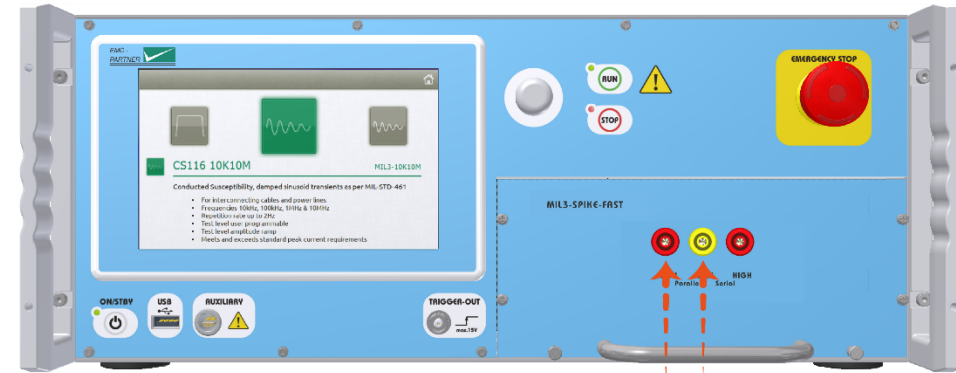

VERI5



MIL3000 + MIL3-SPIKE-FAST

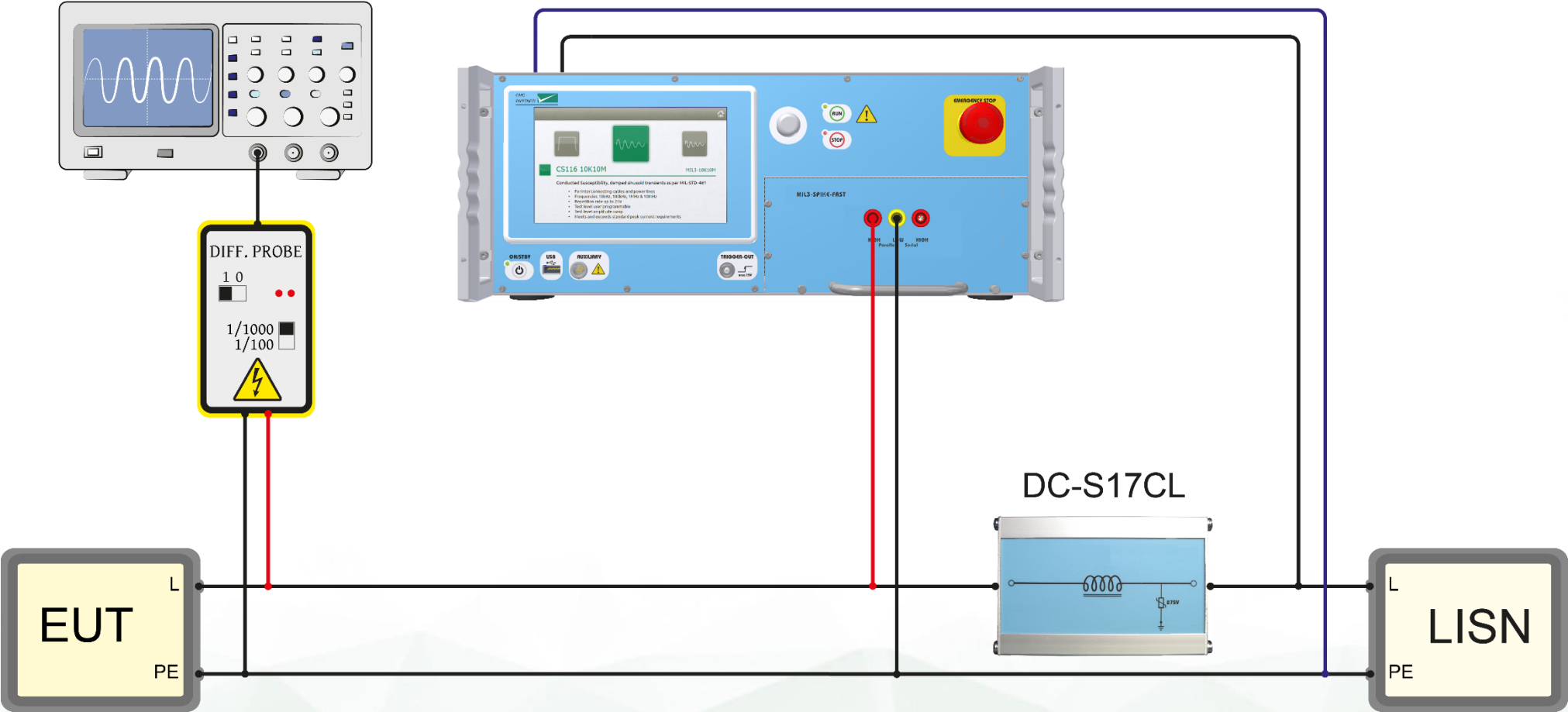

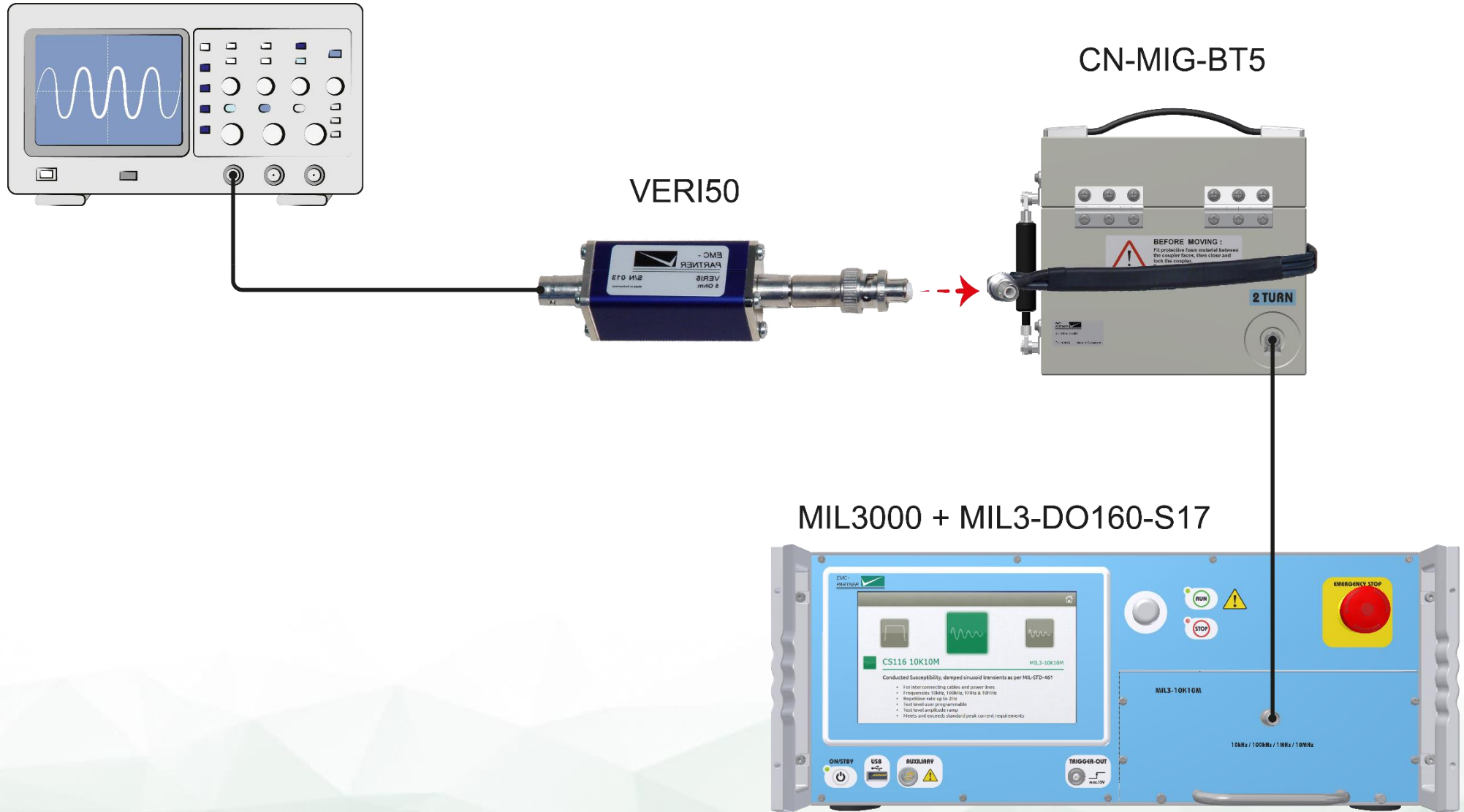

✓ Calibration loop included in delivery

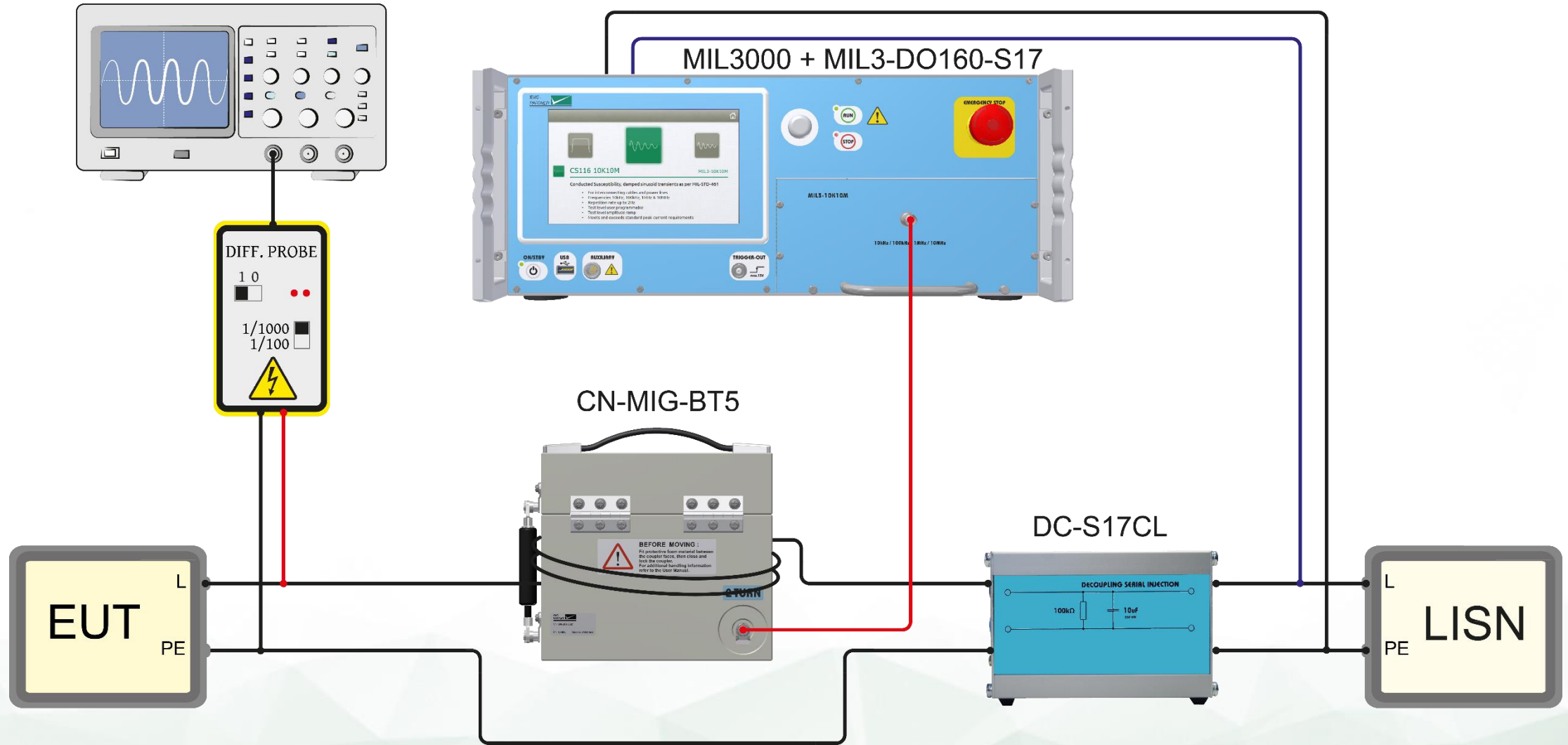

✓ For serial injection, parallel capacitor module(s) from DC-S17CL can be used

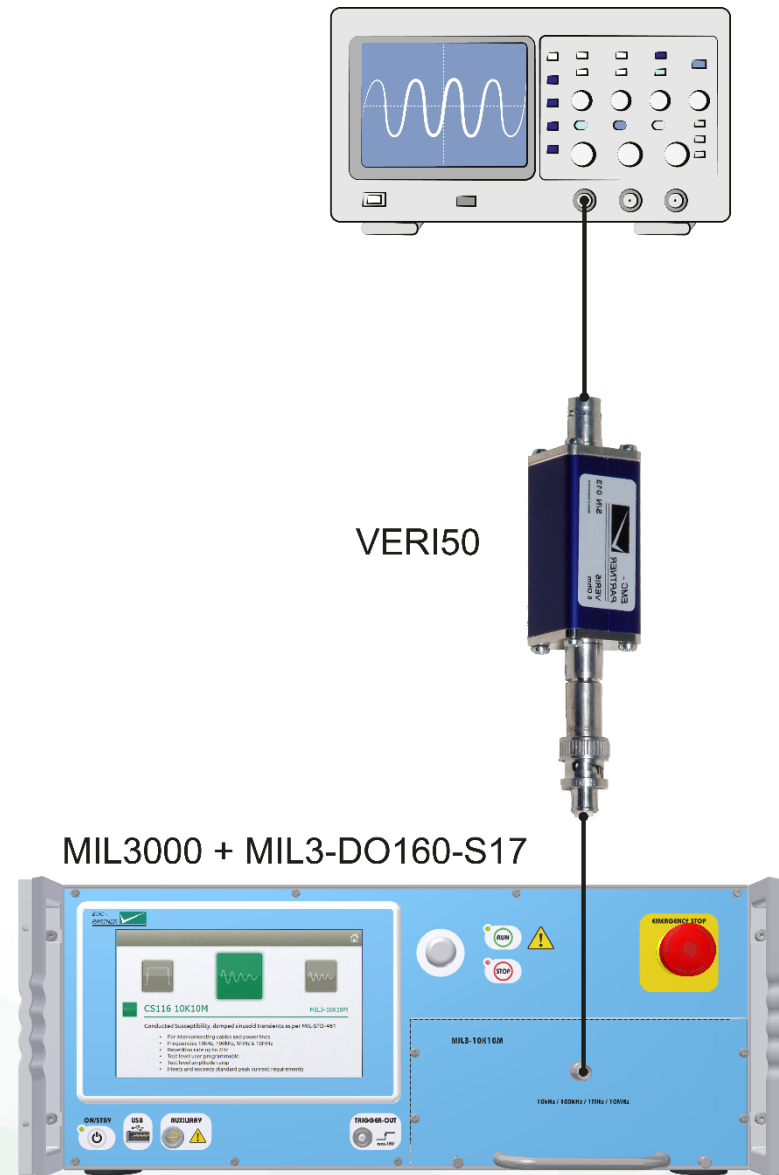

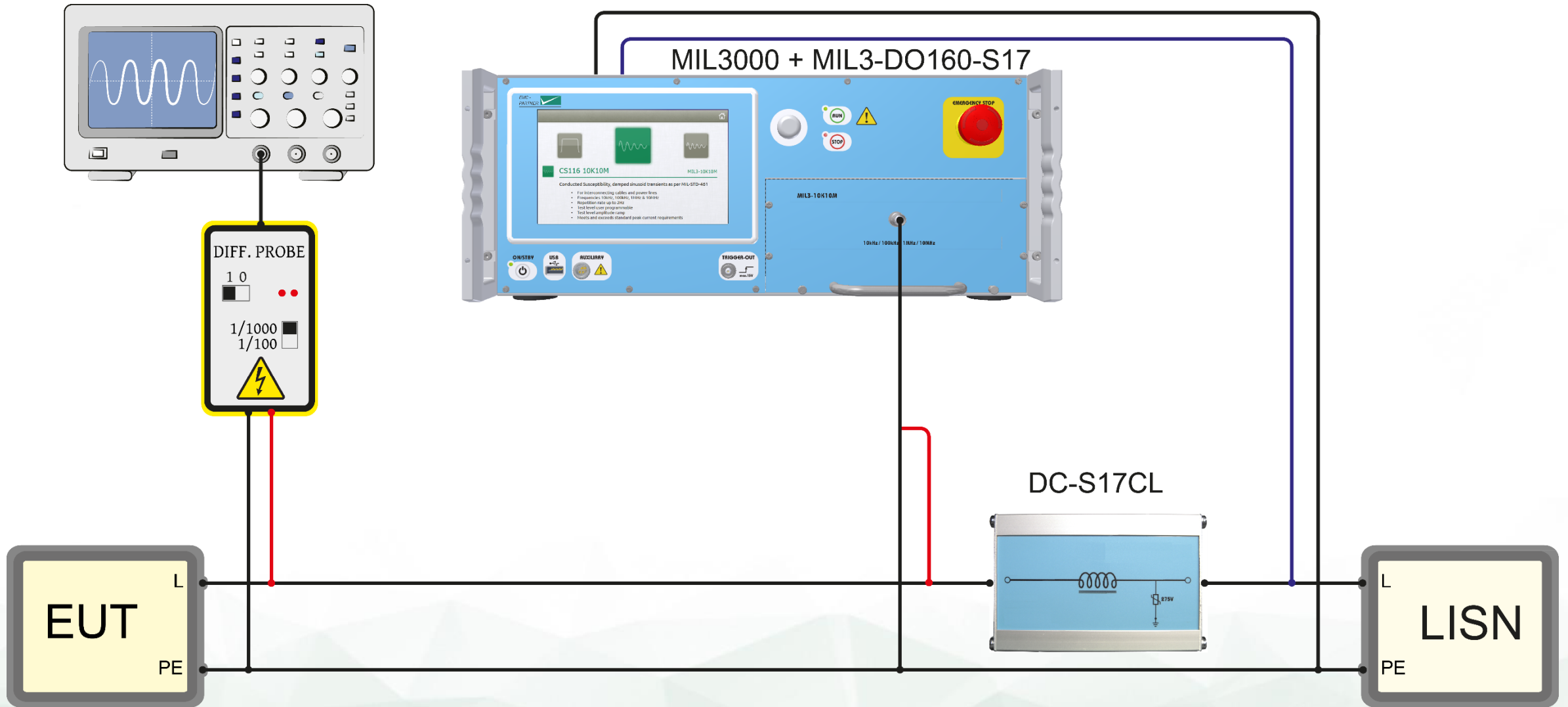

✓ For parallel injection, series inductor(s) from DC-S17CL can be used

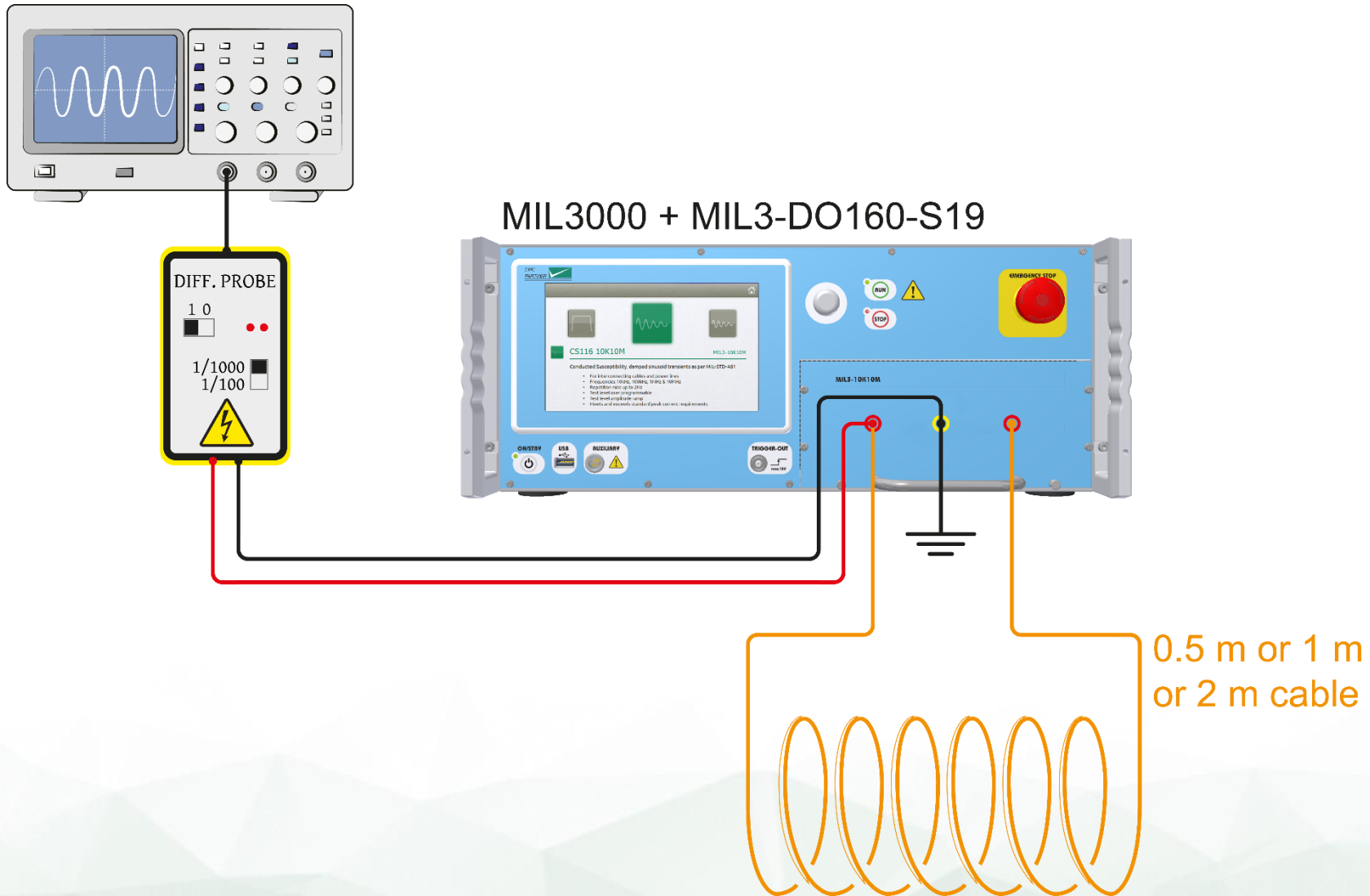

MIL3000 + MIL3-DO160-S19

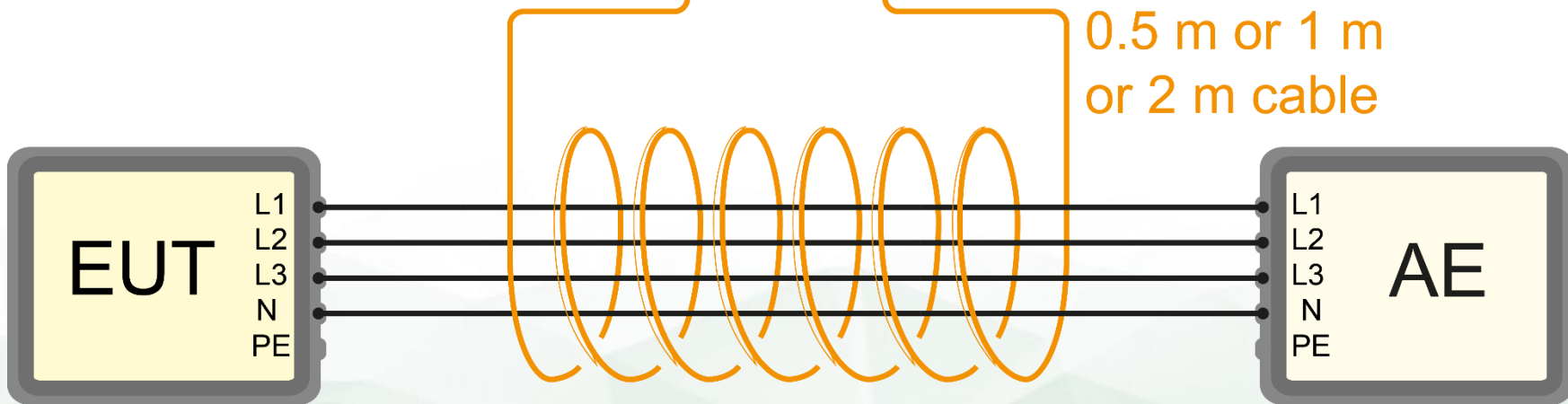
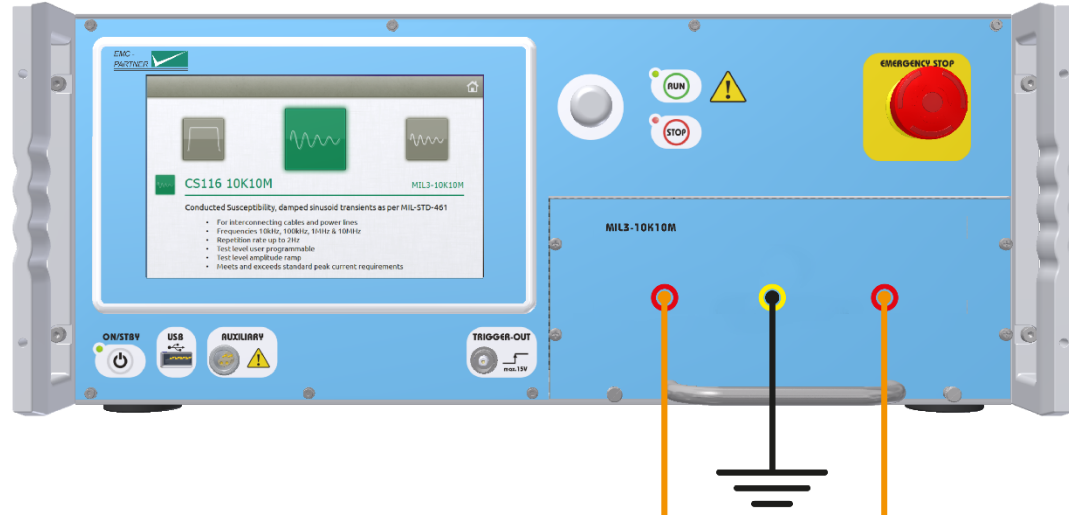

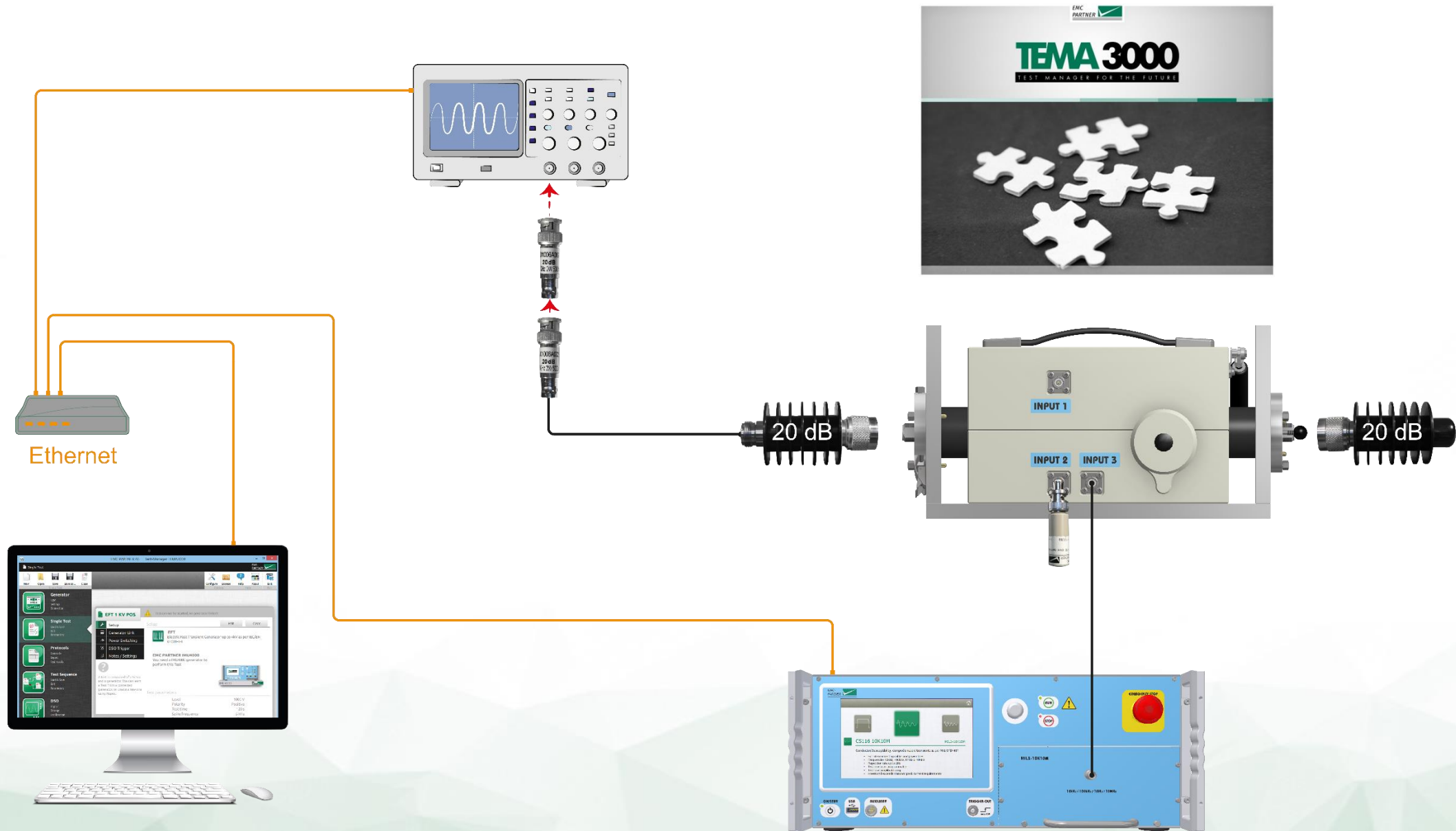



MIL3000 - calibration and test setups

www.emc-partner.com