

User Manual

# MIL-MG3

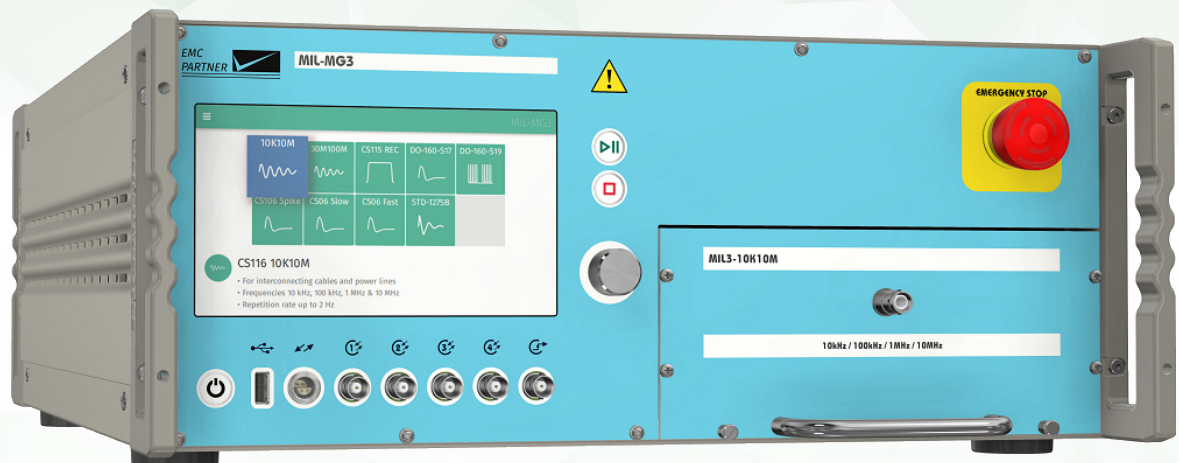

- MIL3-10K10M
- MIL3-30M100M
- MIL3-DO-160-S17
- MIL3-DO-160-S19
- MIL3-SPIKE
- MIL3-SPIKE-SLOW
- MIL3-SPIKE-FAST
- MIL3-REC
- MIL3-1275B
- CN-BT6
- CN-MIG-BT5
- VERI-MIL3
- DC-S17CL
- VERI50
- VERI5

## The Manufacturer

EMC PARTNER AG  
Baselstrasse 160  
4242 Laufen  
Switzerland

Phone +41 61 775 20 30

Fax +41 61 775 20 59

service@emc-partner.ch

## Your Local Representative

Check [www.emc-partner.ch](http://www.emc-partner.ch) to find your local representative

## Typographical Conventions



### Warnings

Safety notices that must be heeded are indicated with this warning triangle.



### Additional Advice

Throughout the user manual very important or helpful advice is indicated with this symbol.

## The Small Print



All products from EMC PARTNER, where appropriate, fulfil the requirements for CE and UKCA certification. A copy of the individual certificates can be viewed and downloaded from [www.emc-partner.com](http://www.emc-partner.com) section company documents.

Version 5.15

Technical Data 4.51

This document may only be reproduced or distributed as the complete document. Partial reproduction of this document requires full, written approval of EMC PARTNER.

Generated on 7th November 2022 with opensource software L<sup>A</sup>T<sub>E</sub>X

Subject to change without notice.

## Safety Instructions



This warning sign is visible on the tester. Meaning: This equipment should only be operated by trained personnel after carefully reading the user manual.

The system belongs to safety class 1.

The system fulfils the requirements of the safety standards IEC 61010 for laboratory measurement equipment "Safety requirements for electrical measuring, control and laboratory equipment".

Consider always the following safety points

- Dangerous mains voltage or high voltages are present inside the test equipment and ALL devices attached to it.
- The Protective Earth must be connected to Earth on the test equipment.
- Before removing any covers from the test equipment, remove all external connection cables.
- Before changing the mains fuse, remove all external connection cables.
- Fuses should only be replaced with the same type and value.
- People with heart pacemakers must not be in the vicinity of the test equipment when it is in operation.
- Do not switch on or operate the test equipment if an explosion hazard exists.
- The test equipment should be operated in a dry room. If condensation is visible, the affected unit(s) should be dried before operating.
- Never touch the Equipment Under Test (EUT), when the test system is operating.
- Establish a safety barrier around the EUT and if required connect it to the safety circuit in the auxiliary connector on the rear panel. The cables under high voltage must not be touched during testing.
- The EUT should be covered and/or well marked during the tests.
- If protective parts are tested, which are likely to explode during tests, they must be covered with a protective cabinet.
- If the test equipment or any of the system components are damaged or it is possible that damage has occurred, for example during transportation, do not apply any voltage.
- This user manual is an integral part of the test system. EMC PARTNER and its sales partners refuse to accept any responsibility for consequential or direct damage to persons and/or goods due to non-observance of instructions contained herein or due to incorrect use of the test equipment.

## Sicherheitshinweise



Gefahr! Dieses Warnsymbol ist am Tester sichtbar angebracht. Es bedeutet: Diese Ausrüstung darf nur durch ausgebildetes Personal bedient werden, nachdem diese die Bedienungsanleitung sorgfältig gelesen hat.

Das Gerät gehört der Schutzklasse I an.

Das Gerät erfüllt die Anforderungen der Sicherheitsnormen IEC 61010 für Messungen in Laboratorien "Sicherheitsanforderungen an elektrische Mess- und Regelgeräte sowie Laborausrüstung".

Beachten Sie stets die folgenden Sicherheitshinweise:

- Gefährliche Netzspannung oder Hochspannung liegt im Inneren der Testausrüstung und an ALLEN daran angeschlossenen Geräten an.
- Der Schutzerdanschluss der Testausrüstung muss mit der Schutzerde des Netzes verbunden sein.
- Bevor Sie irgendwelche Abdeckungen von der Testausrüstung entfernen, entfernen Sie alle äusseren Anschlusskabel.
- Bevor Sie die Netzsicherung austauschen, entfernen Sie alle äusseren Anschlusskabel.
- Netzsicherung nur mit demselben Typ und Ansprechwert ersetzen.
- Personen mit Herzschrittmacher dürfen sich nicht in der Nähe des Geräts aufhalten, wenn dieses in Betrieb ist.
- Schalten Sie die Testausrüstung nicht ein oder betreiben Sie das Gerät nicht, wenn Explosionsgefahr besteht.
- Die Testausrüstung darf nur in einem trockenen Raum betrieben werden. Wenn Kondensation (Beschlag) sichtbar ist, sind die betroffenen Teile der Ausrüstung zu trocknen.
- Berühren Sie niemals die getestete Ausrüstung (EUT), wenn das Testsystem arbeitet.
- Stellen Sie eine Sicherheitsabtrennung rund um das EUT auf und verbinden Sie diese, wenn verlangt, mit dem Sicherheitskreis im Hilfsanschluss (Auxiliary) an der Rückwand. Die unter Hochspannung stehenden Kabel dürfen während des Tests nicht berührt werden.
- Während des Tests sollte das EUT abgedeckt und / oder gut markiert werden.
- Wenn Schutzelemente leicht explodieren können während Tests, müssen diese mit einem schützenden Deckel abgedeckt werden.
- Legen sie keine Spannung an, wenn die Testeinrichtung oder irgendwelche Systembestandteile beschädigt sind oder möglicherweise ein Schaden eingetreten ist, zum Beispiel beim Transport.
- Diese Bedienungsanleitung ist ein vollständiger Bestandteil des Testsystems. EMC PARTNER und seine Verkaufspartner lehnen jede Verantwortung für direkte wie für Folgeschäden an Personen oder Gütern ab, die aufgrund von Nichtbeachten von hierin enthaltenen Anweisungen oder aufgrund von unrichtigem Gebrauch dieser Testausrüstung entstehen.

## Consignes de sécurité



Ce sigle d'avertissement est visible sur le testeur. Signification : Cet équipement ne doit être utilisé que par du personnel formé et après avoir soigneusement lu le mode d'emploi.

Le système appartient à la classe de sécurité 1

Le système répond aux exigences des normes de sécurité CEI 61010 pour les équipements de laboratoire "Exigences de sécurité pour les appareils électriques de mesure, de contrôle et d'équipement de laboratoire".

Considérez toujours les points de sécurité suivants :

- Des tensions secteur dangereuses ou des tensions élevées sont présentes à l'intérieur de l'équipement de test et de TOUS les périphériques.
- La mise à la terre de l'équipement de test doit être effectuée.
- Avant de retirer les couvercles de l'équipement, débranchez tous les câbles de connexion externes.
- Avant de changer le fusible secteur, débranchez tous les câbles de connexion externes.
- Les fusibles ne doivent être remplacés que par le même type et valeur.
- Les personnes portant un stimulateur cardiaque ne doivent pas se tenir à proximité de l'équipement de test lorsqu'il est sous tension d'opération.
- Ne pas allumer ou faire fonctionner l'équipement de test si un risque d'explosion existe.
- L'équipement de test doit être utilisé dans un local sec. Si de la condensation est visible, les appareils affectés doivent être séchés avant utilisation.
- Ne jamais toucher l'équipement sous test (EST), lorsque le système est sous fonction.
- Mettre en place une barrière de sécurité autour de l'EST et, si nécessaire raccorder la au circuit de sécurité du connecteur auxiliaire sur le panneau arrière. Les câbles sous haute tension ne doivent pas être touchés pendant le test.
- L'EST doit être couvert et / ou bien marqué pendant les essais.
- Si des éléments de protection sont susceptibles d'exploser lors de tests, ils doivent être couverts avec un boîtier de protection.
- Si l'équipement de test ou l'un des composants du système ont été endommagés ou il est possible que des dommages ont eu lieu, par exemple pendant le transport, ne pas appliquer de tension.
- Ce manuel fait partie intégrante du système de test. EMC PARTNER et ses partenaires commerciaux refusent d'accepter toute responsabilité pour des dommages indirects ou directs à des personnes et / ou des marchandises dues au non-respect des instructions contenues dans ce document ou en raison d'une mauvaise utilisation de l'équipement de test.

## Contents

<b>1</b>	<b>System Overview</b>	<b>9</b>
1.1	MIL-MG3 (PN 109924) . . . . .	9
1.2	CN-BT6 (PN 107244) . . . . .	9
1.3	VERI-MIL3 (PN 107245) . . . . .	10
1.4	CN-MIG-BT5 (PN 104910) . . . . .	10
1.5	DC-S17CL (PN 103674) . . . . .	10
1.6	VERI50 (PN 103572) . . . . .	10
1.7	VERI5 (PN 103573) . . . . .	11
1.8	SHUNT0E1 (PN 103575) . . . . .	11
1.9	VERI01 OSI (PN 103570) . . . . .	11
1.10	20dB Attenuator (PN 104372) . . . . .	11
1.11	I-PROBE-CS (PN 108372) . . . . .	11
<b>2</b>	<b>Initial Operation</b>	<b>13</b>
2.1	Unpacking and Checking . . . . .	13
2.2	Installation . . . . .	13
2.3	Powering the Equipment . . . . .	13
2.4	Safety Circuit . . . . .	13
<b>3</b>	<b>Hardware Description</b>	<b>14</b>
3.1	Front Panel . . . . .	14
3.2	Rear Panel . . . . .	15
<b>4</b>	<b>Software User Interface</b>	<b>17</b>
4.1	Home Screen . . . . .	17
4.2	Options Menu . . . . .	18
4.2.1	Setups . . . . .	19
4.2.2	Sequence . . . . .	20
4.2.3	Reports . . . . .	21
4.2.4	Update . . . . .	22
4.2.5	Settings . . . . .	23
4.2.6	Extensions . . . . .	24
4.2.7	Connectors . . . . .	25
4.3	Setting up and Running a Test . . . . .	27
<b>5</b>	<b>General Setups</b>	<b>30</b>
5.1	Setups with Emergency Stop . . . . .	30
5.2	Setups with Warning Lamp . . . . .	31
5.3	Setups with Test Cabinet . . . . .	32
<b>6</b>	<b>Tests as per MIL-STD-461</b>	<b>34</b>
6.1	Test as per MIL-STD-461 CS115 Bulk Cable Injection, Impulse Excitation . . . . .	34
6.1.1	System Calibration . . . . .	34
6.1.2	EUT-Test . . . . .	35
6.2	Test as per MIL-STD-461 CS116 Damped Sinusoidal Transients . . . . .	36
6.2.1	Calibration . . . . .	36
6.2.2	EUT-Test . . . . .	37

6.3	Test as per MIL-STD-461 CS106 - MIL3-SPIKE . . . . .	38
6.3.1	Calibration Setup . . . . .	38
6.3.2	Test Setup . . . . .	39
6.4	Test as per MIL-STD-461 CS06 - MIL3-SPIKE-SLOW . . . . .	40
6.4.1	Serial Injection - Calibration Setup . . . . .	40
6.4.2	Serial Injection - Test Setup . . . . .	41
6.4.3	Parallel Injection - Calibration Setup . . . . .	42
6.4.4	Parallel Injection - Test Setup . . . . .	43
6.5	Test as per MIL-STD-461 CS06 - MIL3-SPIKE-FAST . . . . .	44
6.5.1	Serial Injection - Calibration Setup . . . . .	44
6.5.2	Serial Injection - Test Setup . . . . .	45
6.5.3	Parallel Injection - Calibration Setup . . . . .	46
6.5.4	Parallel Injection - Test Setup . . . . .	47
<b>7</b>	<b>Tests as per MIL-STD-1275B</b>	<b>48</b>
7.1	Test as per MIL-STD-1275B - MIL3-1275B . . . . .	48
7.1.1	Test Setup . . . . .	48
<b>8</b>	<b>Tests as per DO160</b>	<b>49</b>
8.1	Tests as per DO160 Section 17 . . . . .	49
8.1.1	Serial Injection - Calibration Setup . . . . .	49
8.1.2	Serial Injection - Test Setup . . . . .	50
8.1.3	Parallel Injection - Calibration Setup . . . . .	51
8.1.4	Parallel Injection - Test Setup . . . . .	52
8.2	Tests as per DO160 Section 19 . . . . .	53
8.2.1	Test Setup . . . . .	53
<b>9</b>	<b>Remote Operation</b>	<b>54</b>
9.1	TEMA3000 . . . . .	54
<b>10</b>	<b>Maintenance and Service</b>	<b>55</b>
10.1	Firmware update . . . . .	55
10.2	Maintenance . . . . .	55
10.3	Cleaning . . . . .	55
10.4	Warranty . . . . .	55
10.5	Customer Service . . . . .	56
10.6	Recycling / Disposal . . . . .	56
<b>11</b>	<b>Technical Data</b>	<b>57</b>
11.1	MIL-MG3 . . . . .	57
11.1.1	MIL-MG3 Main Generator . . . . .	57
11.1.2	MIL3-REC . . . . .	58
11.1.3	MIL3-10K10M . . . . .	58
11.1.4	MIL3-30M100M . . . . .	59
11.1.5	MIL3-DO160-S17 . . . . .	59
11.1.6	MIL3-DO160-S19 . . . . .	60
11.1.7	MIL3-SPIKE . . . . .	60
11.1.8	MIL3-SPIKE-SLOW . . . . .	61
11.1.9	MIL3-SPIKE-FAST . . . . .	62

11.1.10	MIL3-1275B	62
11.2	CN-BT6	63
11.3	CN-MIG-BT5	63
11.4	VERI-MIL3	63
11.5	DC-S17CL	63
11.6	VERI5	64
11.7	VERI50	64
11.8	SHUNT0E1	65
11.9	VERI01 OSI	65



# 1 System Overview



Not all accessories are used for all tests. The chapter “Perform a Test” provides more information.

## 1.1 MIL-MG3 (PN 109924)

MIL-MG3 system comprises a base unit with user changeable impulse modules. A coupling transformer, for cable injection tests, completes the system. The 7 inch graphic colour touch panel provides an intuitive and comfortable user interface. Interactive parameter input, help text and graphic illustrations guide the user through the instrument programming process.



### 1.1.1 Modules

Modules are available for MIL-MG3 system to cover different test requirements. Users can select a module for an individual test and add additional modules to enhance the test system capability. New modules are automatically recognized and controlled by the MIL-MG3 base unit. All modules are independent and can be ordered at any time. Available Modules are

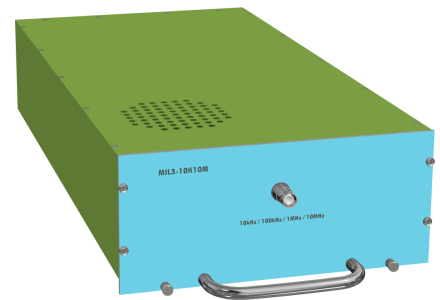

- MIL3-REC (for CS115, PN 107241)
- MIL3-10K10M (for CS116, PN 107239)
- MIL3-30M-100M (for CS116, PN 107240)
- MIL3-SPIKE (for MIL-STD-461 CS106, PN 107483)
- MIL3-SPIKE-SLOW (for MIL-STD-461 CS06, PN 109239)
- MIL3-SPIKE-FAST (for MIL-STD-461 CS06, PN 109241)
- MIL3-DO160-S17 (for DO160 Section 17, PN 107484)
- MIL3-DO160-S19 (for DO160 Section 19, PN 107485)
- MIL3-1275B (for MIL-STD-1275B, PN 107595)

## 1.2 CN-BT6 (PN 107244)

Injection probe for CS115 and also CS116. A single coupler that covers the complete frequency range 10 kHz up to 100 MHz. Aperture 5 cm for large cable bundles.



### 1.3 VERI-MIL3 (PN 107245)

Coaxial calibration fixture for use with CS115 and CS116 waveforms. Supplied with

- 2 x 20 dB N-type attenuators
- 2 x 20 dB BNC-type attenuators
- 1 x cable 1 m N to BNC

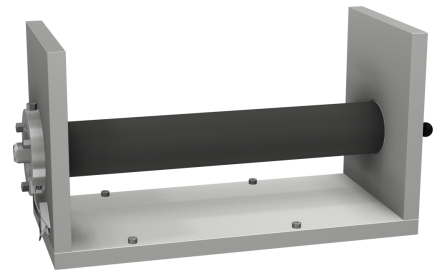

### 1.4 CN-MIG-BT5 (PN 104910)

Injection probe for MIL3-DO-160-S17, MIL3-SPIKE and MIL3-SPIKE-SLOW.



### 1.5 DC-S17CL (PN 103674)

The de-coupling set is used for voltage spike tests to protect the supply sources or auxiliary equipment. The DC-S17CL consists of two de-coupling boxes "PARALLEL INJECTION" and two boxes "SERIAL INJECTION".



### 1.6 VERI50 (PN 103572)

50 Ohm termination with integrated voltage divider.



### 1.7 VERI5 (PN 103573)

5 Ohm termination with integrated voltage divider.



### 1.8 SHUNTOE1 (PN 103575)

0.1 Ohm shunt with SHV-BNC connector for direct measurement of current impulses.



### 1.9 VERI01 OSI (PN 103570)

0.1 Ohm low impedance shunt with SHV-BNC connector for the MIL-SPIKE-FAST current calibration.



### 1.10 20dB Attenuator (PN 104372)

Used with MIL3-10K10M module to reduce generator output. Only needed for tests where the EUT is very sensitive. NOT required for calibration.



### 1.11 I-PROBE-CS (PN 108372)

Current monitor probe used during CS115 and CS116 testing to ensure the anticipated test level is not exceeded. Measurement bandwidth up to 200MHz.

### 1.11.1 V-PROBE-SI (PN 105107)

The V-PROBE-SI is a differential voltage probe with a system bandwidth from DC up to 70 MHz. The maximum voltage rating is  $\pm 7000$  V peak or  $\pm 2000$  Vrms.

## 2 Initial Operation

### 2.1 Unpacking and Checking

1. Check the packaging for signs of damage. If damage is visible, report this to the shipping company immediately.
2. Gently remove the equipment from the packaging.
3. Check the delivery for completeness using the delivery note and the accessory lists for the various items. If something is missing, contact EMC PARTNER or your local sales representative immediately.
4. Check the equipment for any damage. If there is damage, immediately contact the shipping company who made the delivery.



Retain the original packing material for a safe transport at a later date.

### 2.2 Installation

The equipment is designed for use under laboratory conditions. Make sure that all fan openings are unobstructed, that the airflow perforations are unimpeded, and that the minimum distance from the wall is 10cm. An insufficient airflow can cause the equipment to overheat, which may disturb the operation and even cause damage.



Most equipment from EMC PARTNER can be mounted in a 19" Rack. A special rack mounting kit is available. Contact your local sales representative for a quotation.

### 2.3 Powering the Equipment

Check that the local AC-supply is suitable for the equipment. Power rating of the instrument is indicated on the type plate next to the AC power supply connector located on the rear panel. Only use the supplied power cord to connect to your public power supply.



The equipment must always be connected to protective earth. Check the earth connection on your power outlet before you connect and turn on the equipment.

### 2.4 Safety Circuit

The generator is equipped with a safety circuit. As long as the safety circuit is open, no test can be started. To close the safety circuit

1. connect the auxiliary connector on the rear panel
2. pull out the emergency stop button on the front panel with a slight turn clockwise

A closed safety circuit is indicated by a red illuminated emergency stop button

## 3 Hardware Description

### 3.1 Front Panel

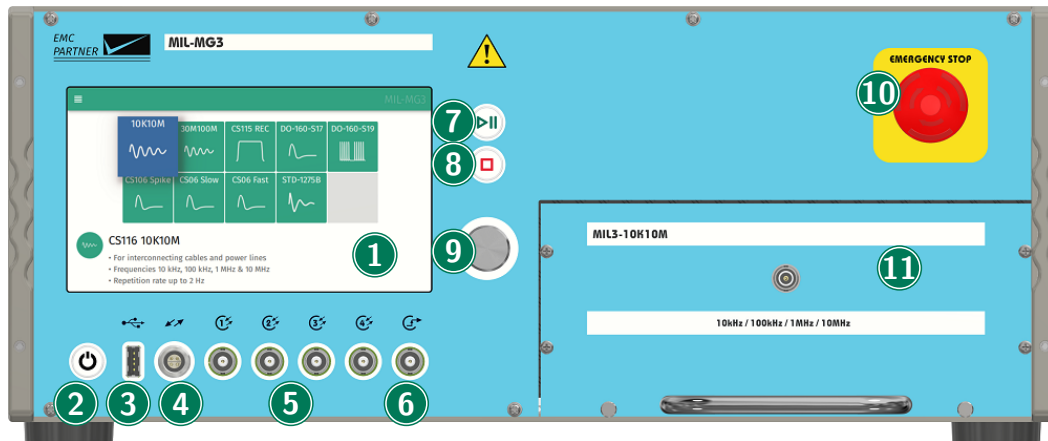

- 1 Touchscreen Monitor**  
User interface to perform all functions including test types selection, parameter entry, saving and recalling tests.
- 2 On/Off/Standby Button**  
Power up or power down the generator.
- 3 USB Port**  
Connect a USB memory stick to copy files (setups, protocols, error logs) from the generator. The USB interface is also used to update the internal firmware.
- 4 Auxiliary Connection**  
Interface for additional external equipment.
- 5 BNC Inputs/Outputs**  
BNC connectors are either measurement outputs for direct connection to an oscilloscope for monitoring various voltages and currents or freely configurable inputs/outputs. Please refer to the chapter Connectors for additional information.
  - BNC1: Freely programmable
  - BNC2: Freely programmable
  - BNC3: Freely programmable
  - BNC4: Freely programmable
- 6 BNC Trigger Output**  
BNC output for a direct connection to the scope to start pulse acquisition. A 6 V signal is generated at every impulse release.
- 7 Run/Pause Button**  
Starts or pauses the selected test.  
A green blinking LED indicates a running test.

- 8 **Stop Button**  
Stops the selected test.  
A red blinking LED indicates a stopped test due to an error.  
A red LED indicates a finished test.
- 9 **Rotary Knob**  
Entry device enables fast navigation and parameter entry.
- 10 **Emergency Stop**  
Push to open the safety circuit. As soon as the safety circuit is open, all running tests are immediately stopped. No more tests can be started.  
Release the emergency stop button with a slight turn clockwise. A closed safety circuit is indicated by a red illuminated emergency stop button.
- 11 **Plug-in Module**  
Exchangeable plug-ins for different wave shapes. The plug-ins are secured by two retained screws on the bottom.



Never remove a plug-in during a running test.

### 3.2 Rear Panel

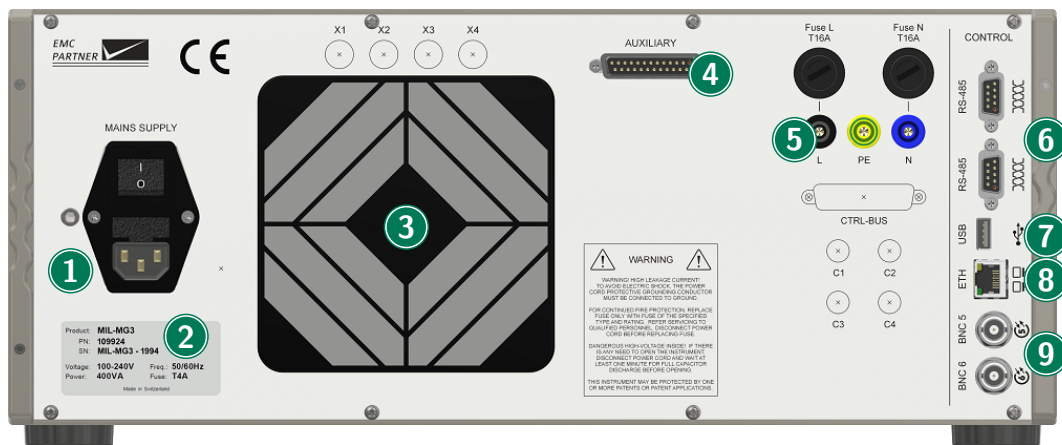

- 1 **AC Socket / Mains Connection**  
A country specific mains cable is delivered with the equipment, this should be used to connect to the mains power supply. A mains fuse is located in the socket housing. The value is indicated on the equipment type plate.  
 Take care to ensure the power mains matches the power ratings on the equipment type plate.  
The generator must always be connected to protective earth.
- 2 **Device Information Panel**  
Product name, serial number (SN), product number (PN), and input power requirements.

### 3 Rear Fan

Rear cooling fan. Take care not to obstruct the opening to assure proper airflow through the generator and prevent overheating.

### 4 Auxiliary Connection

Fit the auxiliary connector delivered with the equipment, to close the safety circuit.

It is possible to extend the safety circuit or to connect additional external warning lamps.

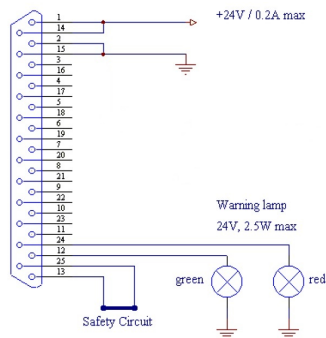

- The green lamp indicates safety circuit open, no test can be started
- The red lamp indicates safety circuit closed, tests can be started

### 5 EUT Power Input

Separate EUT Power input if required for a specific plug-in.

### 6 RS485 Interfaces

Interfaces to connect additional equipment that is controlled directly from the test equipment.

### 7 USB Port

Connect a USB memory stick to copy files (setups, protocols, error logs) from the generator. The USB interface is also used to update the internal firmware.

### 8 Ethernet Interface

Remote control using TEMA3000 software via a common Ethernet interface.

### 9 BNC Inputs/Outputs

Two freely programmable BNC connectors.

Please refer to the chapter Connectors for additional information.



## 4 Software User Interface

### 4.1 Home Screen

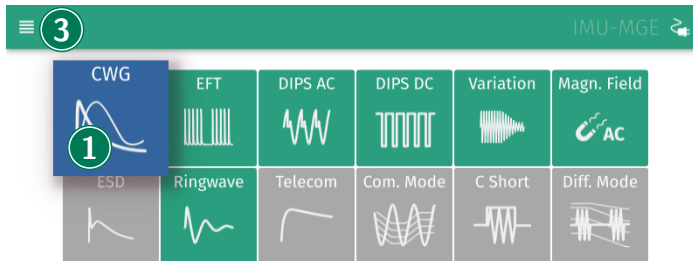

- 1** CWG
- Flexible coupling path selection
  - Automatic voltage adjustment for PE coupling
  - Variable coupling impedance

#### 1 Test Selection

The main window shows all tests available on the equipment. The preselected test is indicated with a blue icon. A green icon indicates that this test is available on your generator. A gray icon indicates that this test is not currently available on your generator. Scroll through the tests with the rotary knob or select one directly on the touch screen. If an unavailable test is selected, a message will be displayed about the modules required for this test but not currently available in your generator.



Not all tests are available all the time. Availability depends on hardware configuration. To simplify the menu structure, tests that are unavailable can be removed from the configuration:

≡ (Options Menu) -> Settings -> Settings -> Home Screen

#### 2 Test Description

A short description is included with each test type.

#### 3 Options Menu

In the top-left corner an Options Menu ≡ (Options Menu) is available. It is an overlay menu giving access to equipment and configuration settings. This menu is always available.

## 4.2 Options Menu

Select  (Options Menu) , to enter the options menu. This menu allows access to all test-independent features of your generator.

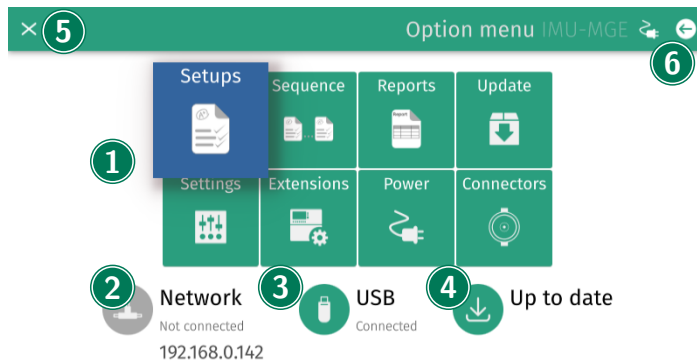

- 1 Utilities**

The options menu includes the various setting options, which are explained in more detail later in this chapter.
- 2 Network**

Indicates if the generator is connected to a network, via the ethernet connector on the rear panel of the generator.
- 3 USB**

Indicates if a USB key is plugged in and recognized by the generator. The USB key can be used to update the generator software and save/load test reports or setups.
- 4 Up to date**

Indicates that the generator software is up-to-date. If the generator is connected to a network with internet access it will automatically look for available updates from EMC PARTNER.
- 5 Exit**

The x-button in the top-left corner can be used to exit the options menu.
- 6 Back**

The arrow-button in the top-right corner can be used to navigate back through the user interface.

## 4.2.1 Setups

Select ≡ (Options Menu) -> Setups, to enter the setups menu.

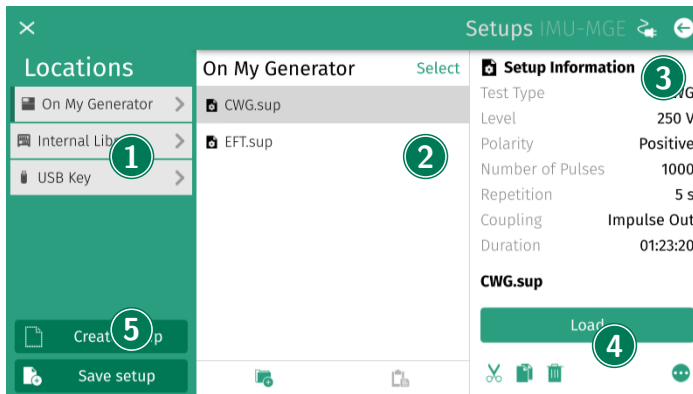

### 1 Root Directory

Select the location where setups are to be displayed and edited. Choose between the EMCP Library with predefined setups, the user defined internal library or setups on the USB stick.



Changed or deleted files inside the built-in EMCP Library will be restored at the next generator startup.

### 2 Saved Setups

All saved setups are listed here. The files can be organized in folders and subfolders.

### 3 Preview

Preview with the most important key data of the selected setups.

### 4 Actions

In addition to loading the stored setup to configure the generator, the files can be further processed in various ways. The setup can be deleted, renamed, copied and moved. It is also possible to save it directly to the USB stick.



Single setup files are copied to a USB memory stick by selecting the file and choosing copy to USB from the menu. To copy multiple setup files, first push select and mark multiple files. When all files to be copied are marked, press copy to USB as normal.

### 5 Save Current Setup

The currently configured test will be saved.

## 4.2.2 Sequence

Select ≡ (Options Menu) -> Sequence, to enter the sequence menu.

You can link up to 15 tests, saved internally to run concurrently.

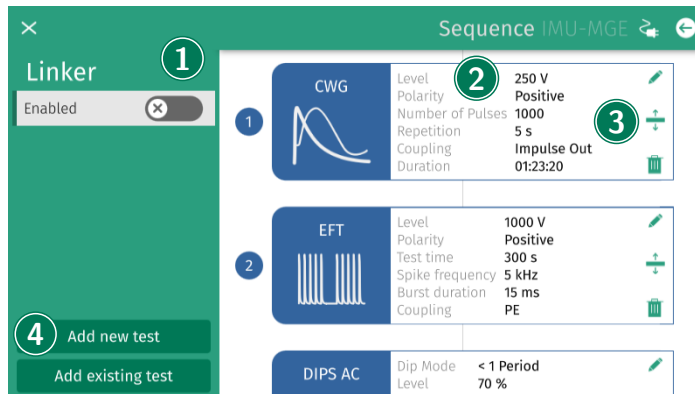

### 1 Activate

If checked, the setup linker is activated. Press run to start the linked tests.

### 2 Preview

The individual tests in the sequence are shown with the most important parameters.

### 3 Edit, Delete, Modify

Edit a single test or delete it completely. Setups are stored as a copy in the setup linker. Any change of parameters or complete deletion has no effect on the source file in the library. The sequence can be changed using Drag & Drop.

### 4 Action

Existing setups can be added into the sequence from the library or a new setup can be created directly.



A linked sequence cannot be saved internally. TEMA3000 Software provides a complete sequence generation package including DSO integration and other applications.

### 4.2.3 Reports

Select ≡ (Options Menu) -> Reports, to enter the reports menu.

A report containing test parameters and results can be saved in the equipment. Additional information about the EUT and environmental conditions can be added.

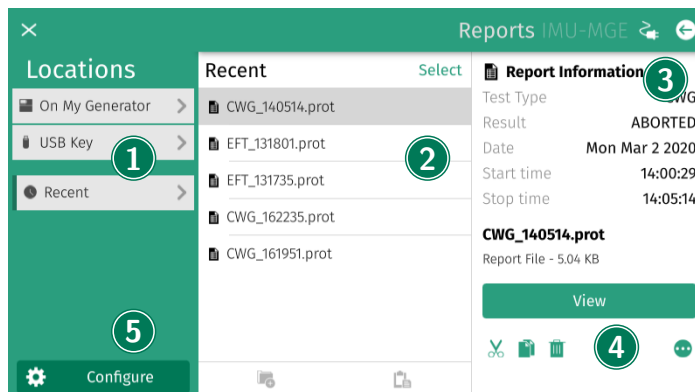

#### 1 Root Directory

Select the location where reports are to be displayed and edited. The last 15 reports are displayed under Recent. This is also the case if the creation of the reports is switched off.

#### 2 Saved Protocols

All saved protocols are listed here. The files can be organized in folders and subfolders.

#### 3 Preview

Preview with the most important key data of the selected report.

#### 4 Actions

In addition to displaying directly on the generator, the reports can be further processed in various ways. The report can be deleted, renamed, copied and moved. It is also possible to save it directly to the USB stick in various formats (PDF, HTML, CVG).



Single protocol files are copied to a USB memory stick by selecting the file and choosing copy to USB from the menu. To copy multiple protocol files, first push select and mark multiple files. When all files to be copied are marked, press copy to USB as normal.

#### 5 Configure

Basic settings for automatic report generation such as storage structure and naming. The default directory structure creates sub directories in the format <year>/<month>/<day>. Additional information about the EUT and the test environment can also be stored. This information is automatically added to each protocol.

## 4.2.4 Update

Select ≡ (Options Menu) -> Update, to enter the update menu.

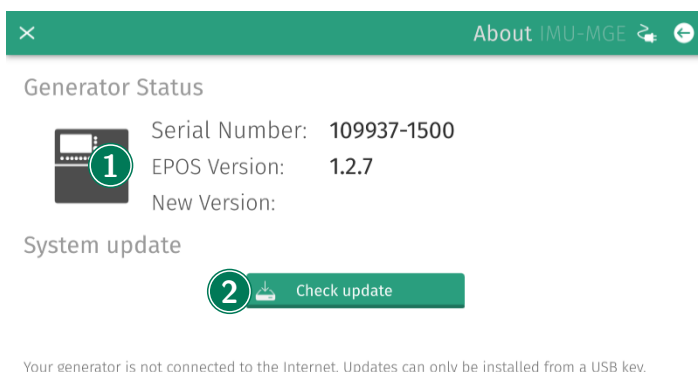

### ① Generator Status

Generator information is shown, such as the generator product and serial number, the current version of the installed EPOS (EMC PARTNER Operating System) software, as well as a new version (if available).

### ② Check Update

Forces the generator to check for available updates, an internet connection is necessary.

## 4.2.5 Settings

Select ≡ (Options Menu) -> Settings, to enter the settings menu.

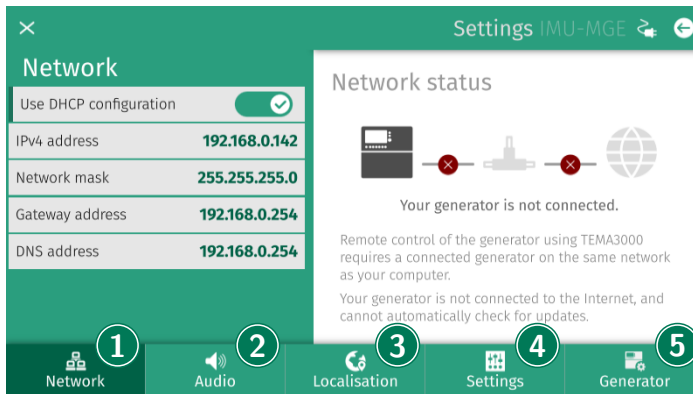

### 1 Ethernet

Depending on the network capability, the TCP/IP address information for the equipment can be obtained in different ways. If the network supports dynamic TCP/IP configuration using the Dynamic Host Configuration Protocol (DHCP), all address information can be assigned automatically. If the network does not support DHCP, or if the equipment is set to use alternate TCP/IP configuration, the address must be set manually. By default, the equipment is configured to use a manual address.



#### Risk of network errors

Connection errors can affect the entire network. If the network does not support DHCP, or dynamic TCP/IP configuration is disabled, assign a valid address information before connecting the equipment to the LAN. Contact the local network administrator to obtain a valid IP address.

### 2 Audio

Volume and type of the different audio messages

### 3 Localisation

Set equipment time and date, and the required format. This information will be included in the test report and file data.



The user interface is available in different languages. English (Default), German, French, Spanish, Italian, Chinese (Traditional), Chinese (Simplified), and Russian. Additional languages can be provided on request. Please contact EMC PARTNER. All translations are made to the best of our knowledge and abilities, however, we cannot guarantee the correctness of all translations.

### 4 Settings

Settings for the general behavior of the generator:

- Generator can stop as soon as the EUT failed.
- The generator can perform different tests from the setup linker.
- During a running test changed parameters can be reset when the test is over.
- The direction of the input knob can be inverted.
- Unavailable tests due to missing hardware can completely be removed (instead as being indicated with a gray icon).

## 5 Generator

Perform a factory reset or copy service data to the USB drive.

### 4.2.6 Extensions

Select ≡ (Options Menu) → Extensions, to enter the extensions menu.

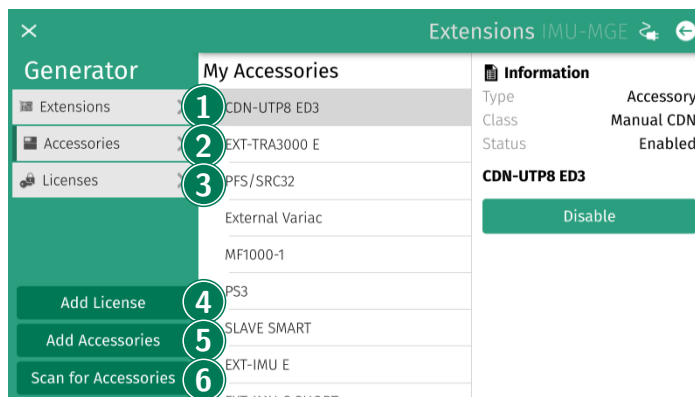

#### 1 Extensions

Shows all internal and external connected extensions. Only extensions which have an active communication with the generator are displayed.

#### 2 Accessories

Listing of all actually available external accessories. The configuration with the actually available external accessories has to be done only once. For a better overview the user interface is adapted to the existing equipment. This adaptation is done automatically based on this configuration.

#### 3 Licenses

Lists all licenses for software options.

#### 4 Add License

Allows adding a new license. Selecting "Add License" opens an on-screen keyboard where you can enter the license key for the software option you have purchased from EMC PARTNER.

#### 5 Add Accessories

Missing accessories can be added manually with "Add Accessories". To find the desired entry faster, the external accessories are grouped into several categories.

#### 6 Scan for Accessories

External accessories that have active communication with the generator via the RS485 bus can be automatically detected and added with a scan.



A scan for newly connected devices is also performed automatically each time the generator is started.



## 4.2.7 Connectors

Select ≡ (Options Menu) -> Connectors, to enter the connectors menu.

There are 4 BNC connectors on the front panel and 2 on the rear panel. The two on the rear panel can always be freely programmed as inputs or outputs. Of the 4 connectors on the front panel, those which are not used as outputs of internal measurements are freely configurable.

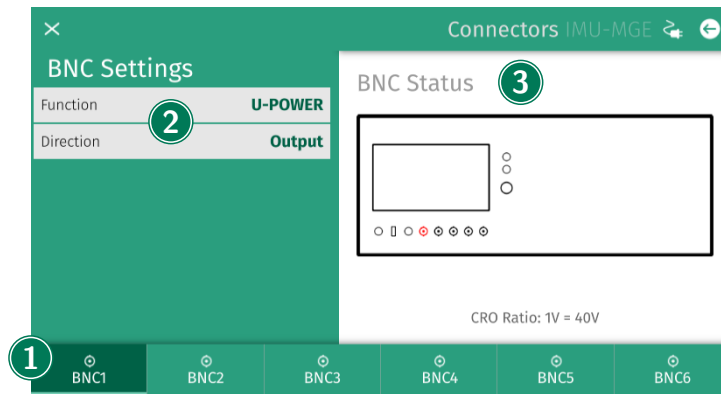

### 1 BNC Connectors

Select between the six BNC connectors on the generator: BNC1-BNC4 are located on the generator front panel, BNC5 and BNC6 are located on the generator rear panel.

### 2 BNC Settings

If it is a fixed measurement output, the designation is given. Otherwise, individual programming is possible. They can be programmed to be either inputs or outputs, with active-high or active-low characteristic. Additionally the debounce time can be set freely. They can be programmed with any one of the following functions:

- No Function
- Trigger Input (Input)
- Emergency Stop (Input)
- EUT Fail (Input)
- EUT Mark (Input)
- Running State (Output)
- Safety Circuit State (Output)
- Start Test (Input)
- Stop Test (Input)



### Block diagram of the interface

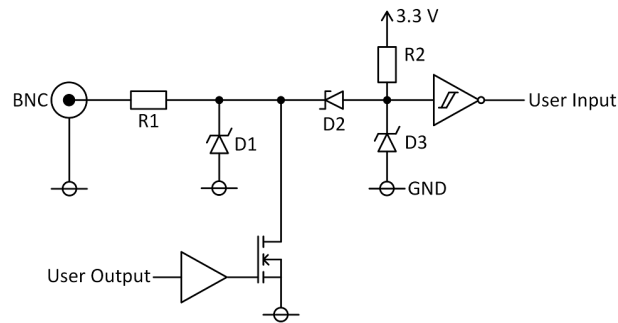

The value of the resistor R1 is 10 Ohm, and the value of R2 is 1kOhm. D1 is a 27V TVS-diode, D2 is a fast Schottky diode, and D3 is a 3.3V TVS-diode.

The output functions as open drain output. Maximum 24 volts for both input and output configuration. Detailed information is given in the technical data

### 3 BNC Status

Provides additional information on the status of the selected connector.

## 4.3 Setting up and Running a Test

The same process is used to program the generator for different tests. In the first step, the parameters should be set according to the requirements of the test.

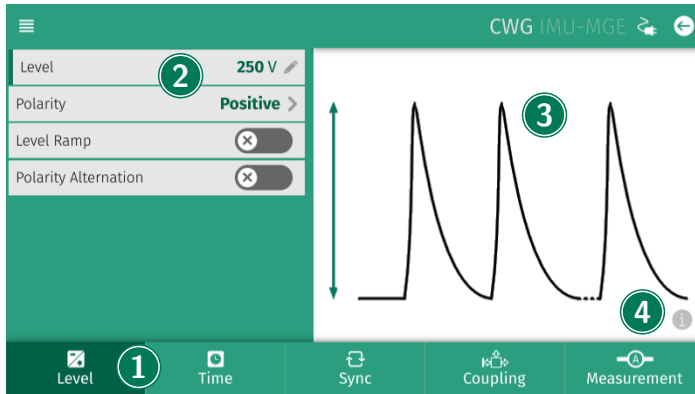

### 1 Main Category

For quick access, categories at the bottom of the display contain groups of relevant parameters. Select a category using the touch panel or the rotary knob.

### 2 Parameter List

All parameters from a selected category are shown on a single screen. Click on a parameter to edit the value.



Press and turn the rotary knob at the same time for a quick parameter change.

All parameters are checked for validity during the entry process. If necessary (for example test level too high), the system automatically corrects the value. Corrected values are indicated by a red background.

The system also checks for inconsistencies with other parameters and, where necessary, makes an adjustment. It is not possible to create a test containing invalid parameters.

### 3 Parameter Image

Individual images clarify the effect of each parameter.

### 4 Parameter Help

For each parameter, an additional help text is provided directly on the generator. Press the info button to open the help text in a popup window.



Starting a test by pressing the run button on the front panel, changes the display to the run view.

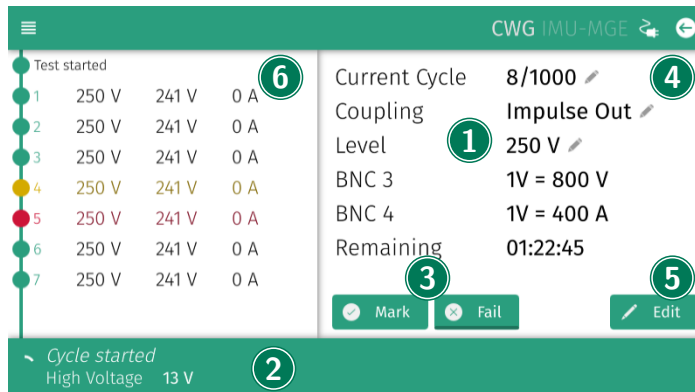

- ① **Information Area**  
Indicates the most important information about a running test.
- ② **Status Bar**  
Provides information about the current event.
- ③ **Mark / Fail**  
Mark or Fail add this information at the current test position. This information will be included in the report.
- ④ **Quick Parameter Change**  
All parameters that are marked with a pencil symbol in the information area can be edited with a single click on the parameter during the test.
- ⑤ **Edit Parameter**  
Many parameters can be edited during an ongoing test. A click on Edit shows all parameters. Modifiable parameters are marked, unchangeable ones are shown with a short animation when clicked. Depending on the test type, parameter change will take place with the next cycle or after a few seconds. Changed values are highlighted for a few seconds in the information area.
- ⑥ **Live Report**  
At this point information about the entire test is displayed. The content depends on the particular test and could include readings, changed parameters or information about warnings. If the test was marked during the run, this is indicated by a yellow marking. If it was highlighted with fail, an entry is made in red.



**Pause and Resume a Test**

Most tests can be paused with a click on the start/pause button. Another click on the Start/Pause button resumes the test at the current position.



During the pause, only the disturbance source is interrupted. A possible EUT voltage will not be switched off. Only a stopped test and an open safety circuit (pressed emergency button) guarantees a safe operation on the connected device.

After the test time has expired or if the test is stopped manually, the complete report is displayed. It is possible to save the report in the desired format (PDF, HTML, CSV) directly to the USB stick.



Under ≡ (Options Menu) -> Reports -> Configure you can set that the protocol is automatically saved in the desired format.

## 5 General Setups



This chapter provides information on general setups which apply to different generators. The setups are shown with a selection of exemplary EMC PARTNER generators, including the IMU-MGS and INS-1250.

The setups presented in this chapter deal with the following accessories which can be used with several EMC PARTNER generators:

- EMERGENCY-STOP (PN 109773)
- WARNING-LAMP (PN 109775)
- TC-ST (PN 109768)

### 5.1 Setups with Emergency Stop

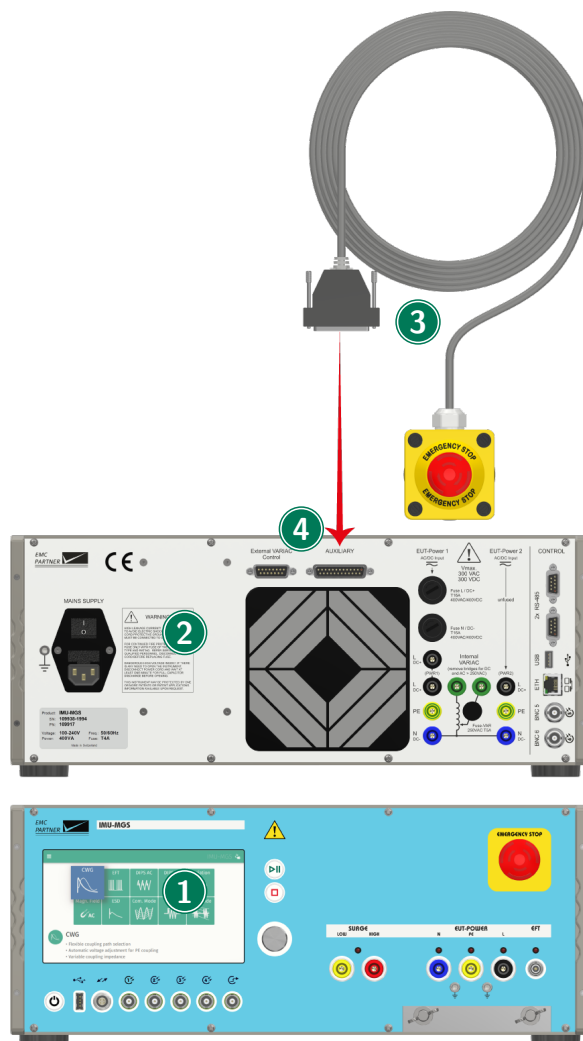

EMERGENCY-STOP

**1 Generator Front Panel**

In this setup the IMU-MGS generator is shown for exemplary purposes. The external emergency stop button can be used with a variety of EMC PARTNER generators.

**2 Generator Rear Panel**

The emergency stop button is connected to the rear panel on the generator. In this setup the IMU-MGS generator rear panel is shown for exemplary purposes. Other EMC PARTNER generators may have different connector arrangements on their rear panel.

**3 External Emergency Stop Button**

The external emergency stop button consists of the button itself, an extension cord with a length of five meters, and the EMC PARTNER standard 25-pin auxiliary connector.

**4 Auxiliary Connector**

The emergency stop button is connected to the 25-pin auxiliary connector located on the rear panel of all EMC PARTNER generators.

## 5.2 Setups with Warning Lamp

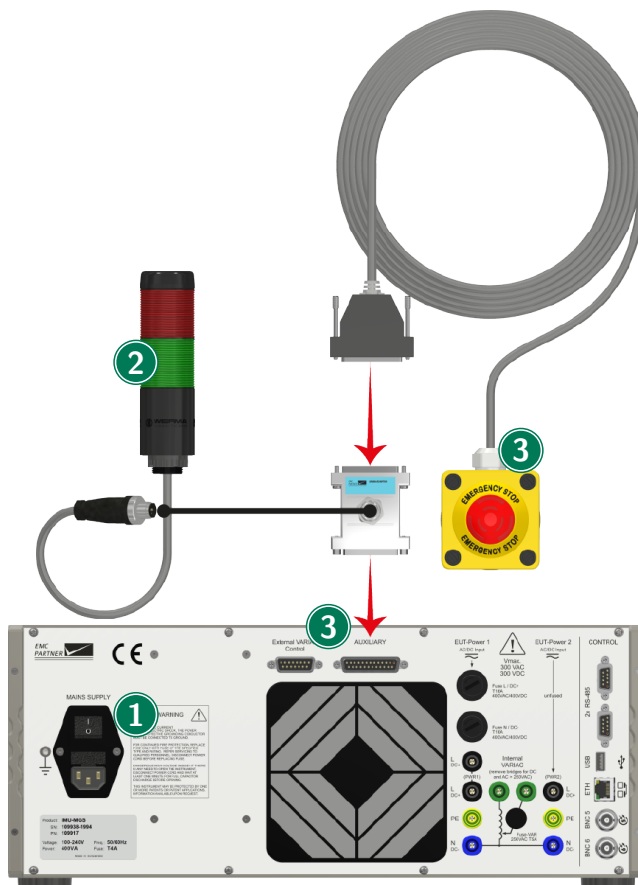

EMERGENCY-STOP WARNING-LAMP

**1 Generator Rear Panel**

The warning lamp and emergency stop button are connected to the rear panel on the generator. In this

setup the IMU-MGS generator rear panel is shown for exemplary purposes. Other EMC PARTNER generators may have different connector arrangements on their rear panel.

### 2 Warning Lamp

The warning lamp consists of the lamp itself as well as an adapter box which is used to connect warning lamp to the generator 25-pin auxiliary output while providing another auxiliary output where a second accessory can be connected. Additionally, the warning lamp comes with a magnetic foot which can be used to fix it to metallic surfaces, a mounting angle, and a three meter extension cable which can be used between the lamp and the adapter box.

### 3 Auxiliary connector

The warning lamp is connected to the 25-pin auxiliary connector located on the rear panel of all EMC PARTNER generators via the included adapter box.

### 4 External Emergency Stop Button

The external emergency stop button consists of the button itself, an extension cord with a length of five meters, and the EMC PARTNER standard 25-pin auxiliary connector. In case both an emergency stop and a warning lamp are used together, the emergency stop is connected to the generator via the adapter box which is part of the warning lamp.

## 5.3 Setups with Test Cabinet

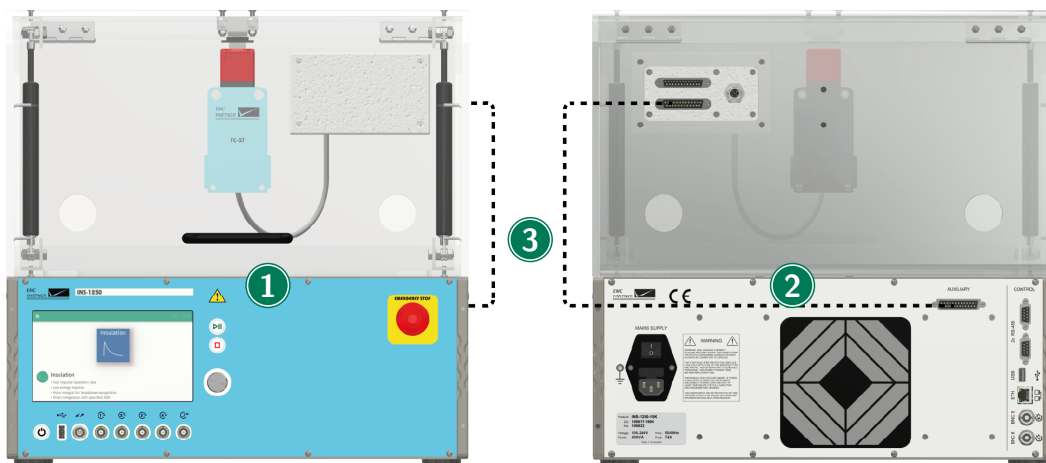

TC-ST

### 1 Generator and TC-ST (front view)

On the left side we provide a front view of an exemplary EMC PARTNER generator (INS-1250) with the test cabinet (TC-ST) mounted on top of the generator. The TC-ST can also be used with other generators and can be placed, e.g. next to the generator, depending on your needs.

### 2 Generator and TC-ST (rear view)

On the right side we provide the rear view of the same setup, i.e. EMC PARTNER generator INS-1250 with TC-ST mounted on top. Note that the rear panel of this generator is less crowded, than the rear panel of the IMU-MGS generator which has been shown in the previous images.

### 3 Auxiliary connection

The generator and test cabinet TC-ST are connected via an auxiliary connector cable between the 25-pin auxiliary connectors located on the rear panels of the generator and the test cabinet respectively.



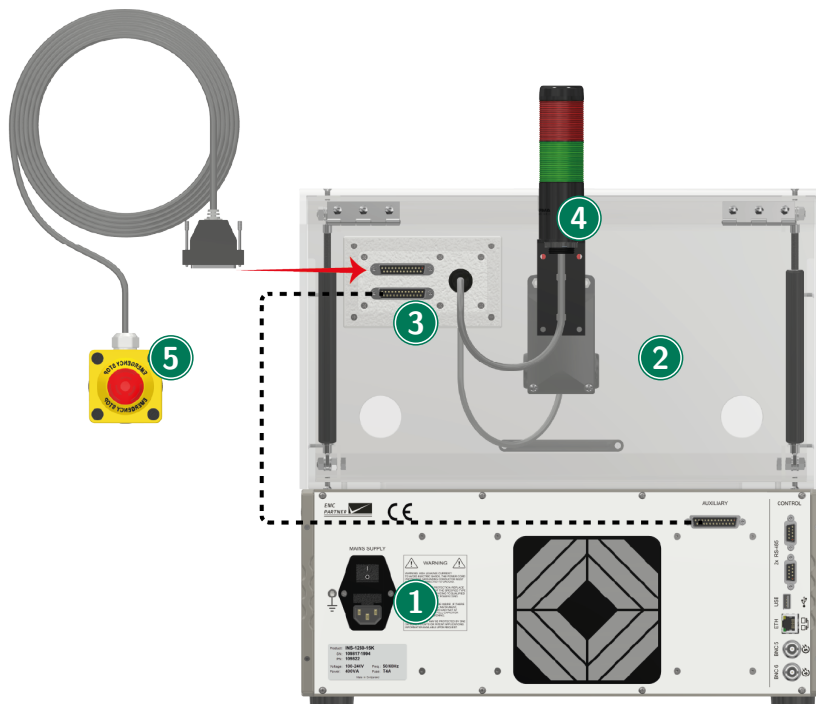

#### TC-ST WARNING-LAMP EMERGENCY-STOP

- ① **Generator**  
Rear panel of the generator - depending on the generator the connector configurations on the rear panel might differ.
- ② **Test Cabinet TC-ST**  
Test cabinet TC-ST placed on top of the generator. The test cabinet can also be placed next to the generator.
- ③ **Test Cabinet Rear Panel**  
The test cabinet rear panel provides two 25-pin auxiliary connectors as well as a dedicated 5-pin connector for the warning lamp. The cabinet is connected to the generator via the provided auxiliary cable between one of the connectors and the auxiliary connector on the generator rear panel.
- ④ **Warning Lamp**  
The warning lamp can be connected directly to the test cabinet rear panel (without the need for the adapter box) and be mounted to the test cabinet using the provided mounting angle.
- ⑤ **External Emergency Stop Button**  
The external emergency stop button can be connected to the generator via the remaining auxiliary connector on the TC-ST. The emergency stop signal is fed through the TC-ST.

## 6 Tests as per MIL-STD-461



Additional information for calibration is also available in the calibration report.

### 6.1 Test as per MIL-STD-461 CS115 Bulk Cable Injection, Impulse Excitation

#### 6.1.1 System Calibration

Prior to each test, the system has to be calibrated. The calibration is made at a fixed test level.

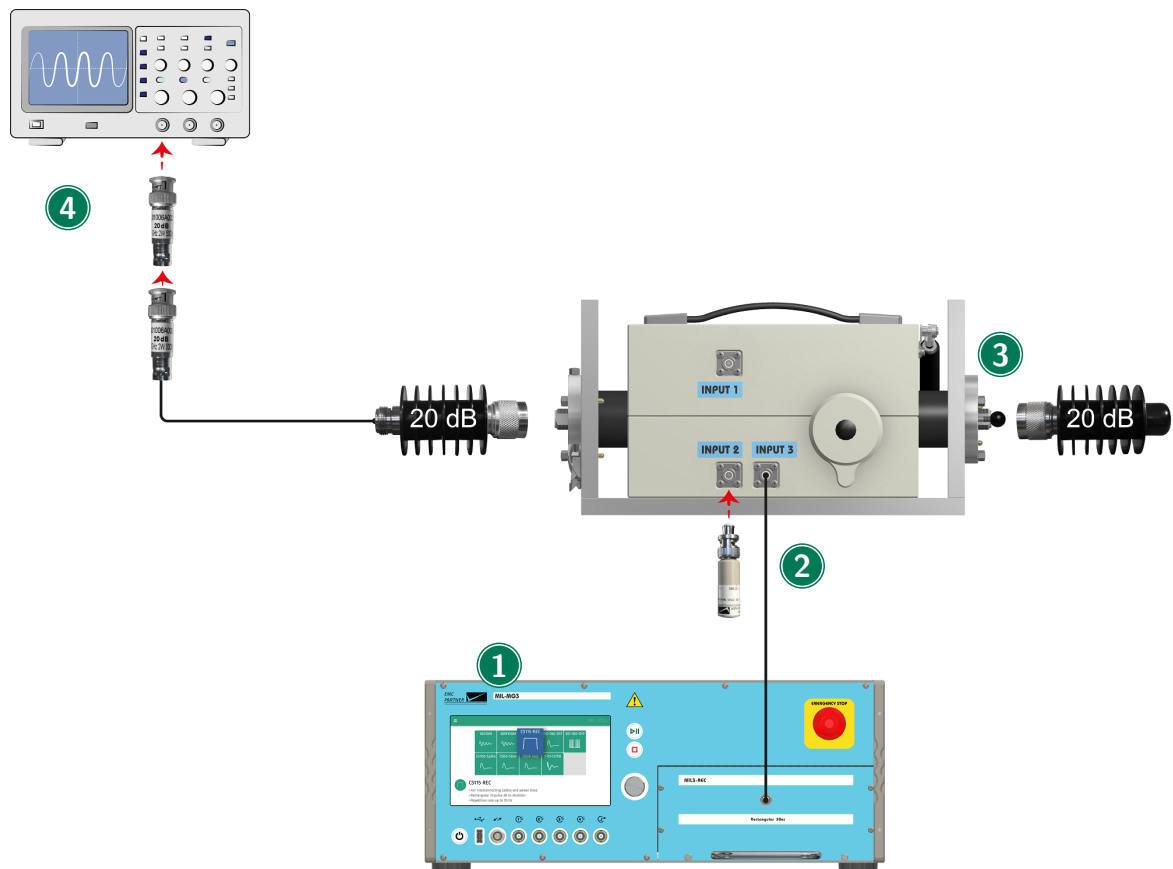

MIL-MG3 - MIL3-REC - VERI-MIL3 - CN-BT6

#### ① Generator

The plug-in MIL3-REC has to be fitted in the generator.

#### ② CN-BT6

The output of the plug-in is connected with the 2 m cable to INPUT 3 of the CN-BT6. INPUT 2 has to be terminated with the 50 Ohm SHV termination. The cable should not lie directly on the ground plane to avoid unwanted reflection.

### 3 Calibration Fixture

The CN-BT6 is fitted into the VERI-MIL3. The center conductor must be removed to insert the coupler. Mount on both sides the 20 dB attenuator. Connect on the left side the N to BNC cable.



To easily remove the central conductor from the calibration fixture, push firmly on the two black balls on its side.

### 4 Oscilloscope

The Oscilloscope has to be set to 50ohm input impedance. To protect the scope, insert additional 2 x 20 dB attenuators (supplied with VERI-MIL3).

## 6.1.2

### EUT-Test

Testing an EUT requires impulse amplitude to be set to a low level and slowly adjusted to the defined test level. This can be automated with the level ramp function in the parameter menu.

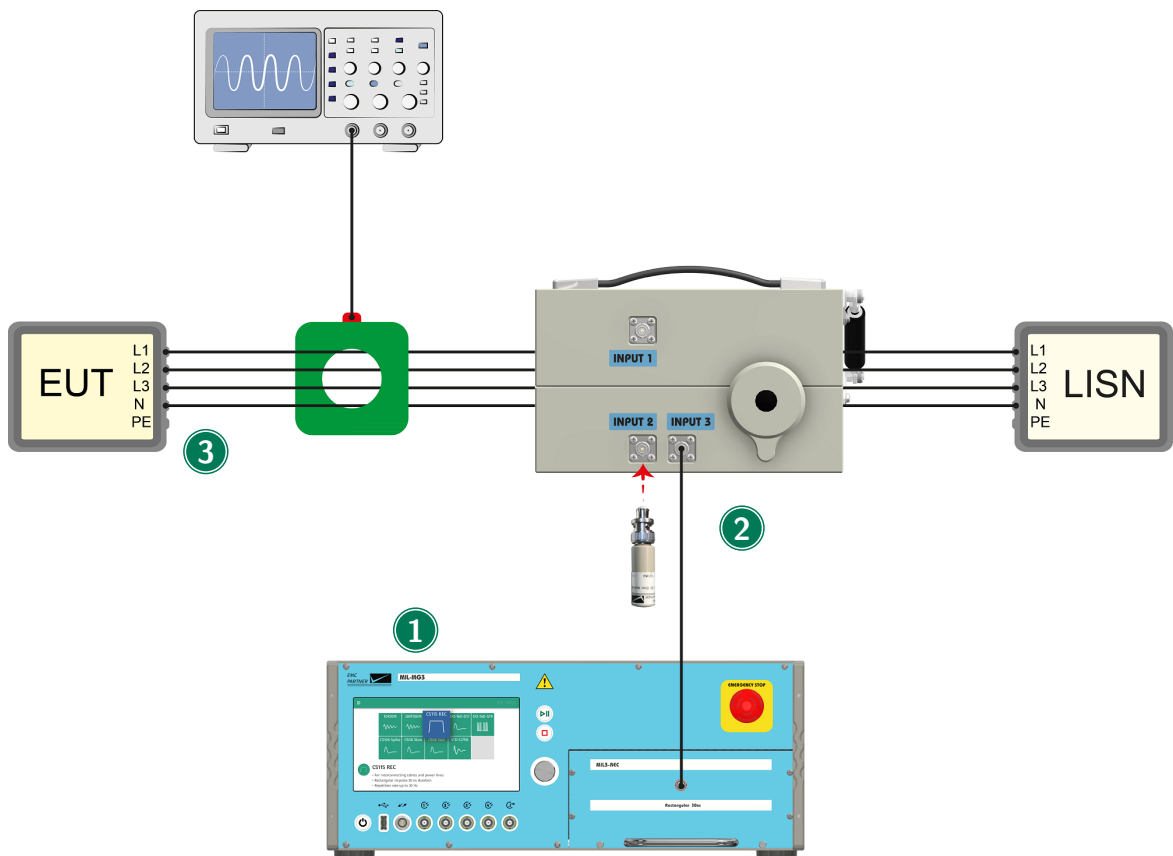

MIL-MG3 - MIL3-REC - CN-BT6 - I-PROBE-CS

### 1 Generator

The plug-in MIL-REC has to be fitted in the generator.

### 2 CN-BT6

The output of the plug-in is connected with the 2 m cable to INPUT 3 of the CN-BT6. INPUT 2 has

to be terminated with the 50 Ohm SHV termination. The cable should not lie directly on the ground plane to avoid unwanted reflection.

### ③ EUT Cable

The coupler and monitor probes are placed around a cable bundle interfacing with the EUT. During the test, the peak current must be monitored to ensure the amplitude does not exceed the value obtained in the calibration setup. The pulse shape is not relevant.

## 6.2 Test as per MIL-STD-461 CS116 Damped Sinusoidal Transients

### 6.2.1 Calibration

Prior to the test, the system has to be calibrated. The calibration is made at a fixed test level.

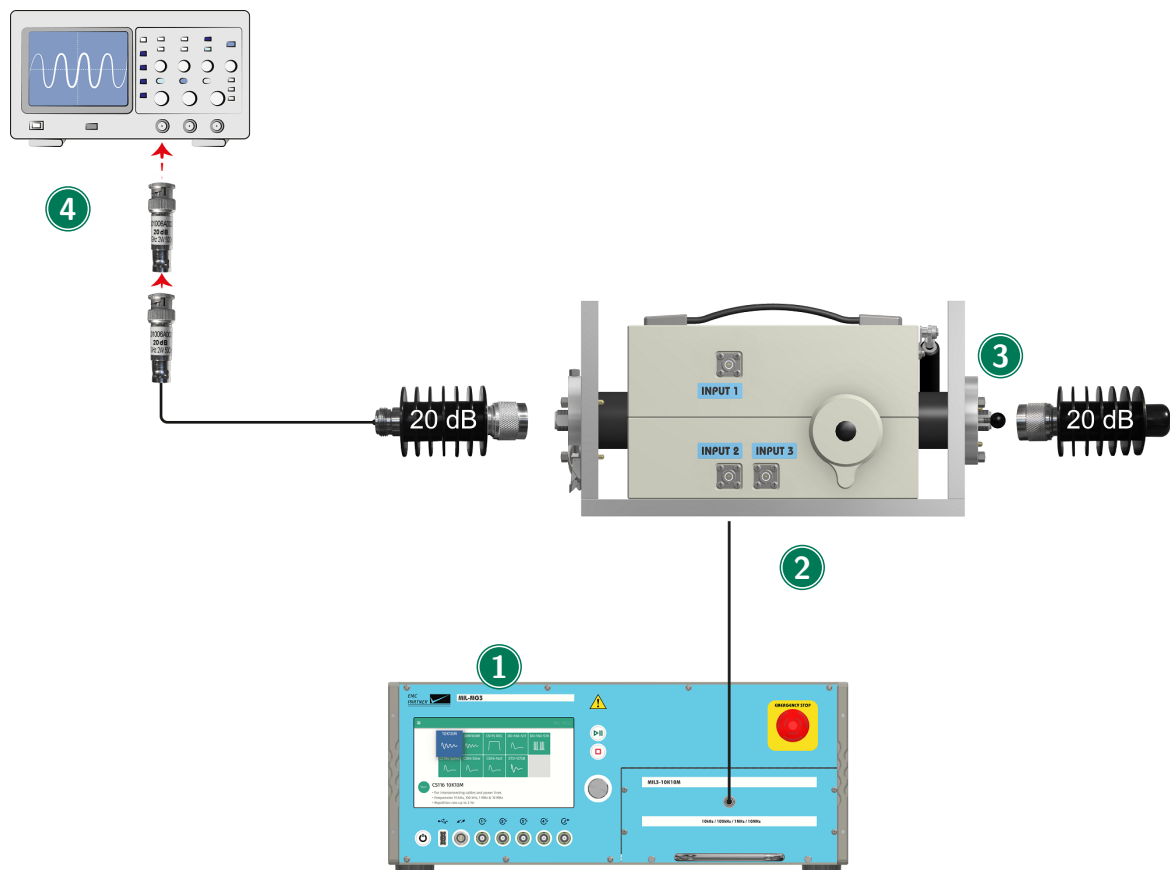

MIL-MG3 - MIL3-10K10M or MIL3-30M-100M - VERI-MIL3 - CN-BT6

### ① Generator

For 10 kHz, 100 kHz, 1 MHz and 10 MHz the plugin MIL3-10K10M has to be fitted in the generator. For 30 MHz and 100 MHz, the MIL3-30M100M is used.

### ② CN-BT6

The output of the plug-in is connected with the input of the CN-BT6. For the different frequencies, different setups are used.

- Up to 10 MHz, INPUT 1 with 1 m cable
- For 30 MHz INPUT 2 with 1 m cable
- For 100 MHz INPUT 2 with 2 m cable

The cable should not lie directly on the ground plane to avoid unwanted reflection.

### 3 Calibration Fixture

The CN-BT6 is fitted into the VERI-MIL3. The center conductor must be removed to insert the coupler. Mount on both sides the 20 dB attenuator. Connect on the left side the N to BNC cable.



To easily remove the central conductor from the calibration fixture, push firmly on the two black balls on its side.

### 4 Oscilloscope

The Oscilloscope has to be set to 50 Ohm input impedance. Due to the low levels, 10 kHz can be measured directly with the scope. For all other frequencies an additional attenuator (2 x 20 dB) must be used to protect the scope.

## 6.2.2

### EUT-Test

When performing tests on sensitive EUTs, it may be necessary to add attenuation between the plug-in and the CN-BT6. Specifically for this task, EMC PARTNER have a 20 dB attenuator which is designed to operate with the high voltage pulses.

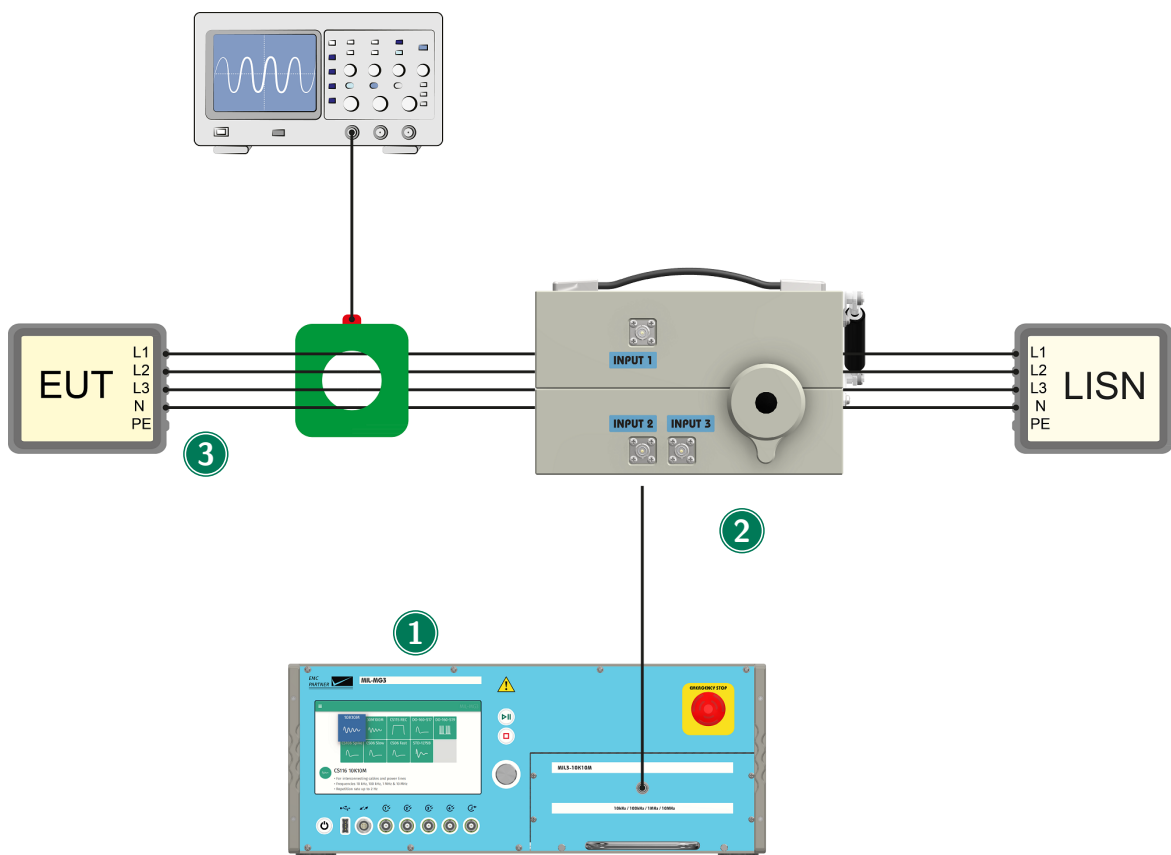

MIL-MG3 - MIL3-10K10M or MIL3-30M100M - CN-BT6 - I-PROBE-CS

**1 Generator**

For 10 kHz, 100 kHz, 1 MHz and 10 MHz the plug-in MIL3-10K10M has to be fitted in the generator.  
For 30 MHz and 100 MHz, the MIL3-30M100M is used.

**2 CN-BT6**

The output of the plug-in is connected with the input of the CN-BT6. For the different frequencies, different setups are used.

- Up to 10 MHz, INPUT 1 with 1 m cable
- For 30 MHz INPUT 2 with 1 m cable
- For 100 MHz INPUT 2 with 2 m cable

The cable should not lie directly on the ground plane to avoid unwanted reflection.

**3 EUT Cable**

The coupler and monitor probes are placed around a cable bundle interfacing with the EUT. During the test, the peak current must be monitored to ensure the amplitude does not exceed the value obtained in the calibration setup. The pulse shape is not relevant.

## 6.3 Test as per MIL-STD-461 CS106 - MIL3-SPIKE

### 6.3.1 Calibration Setup

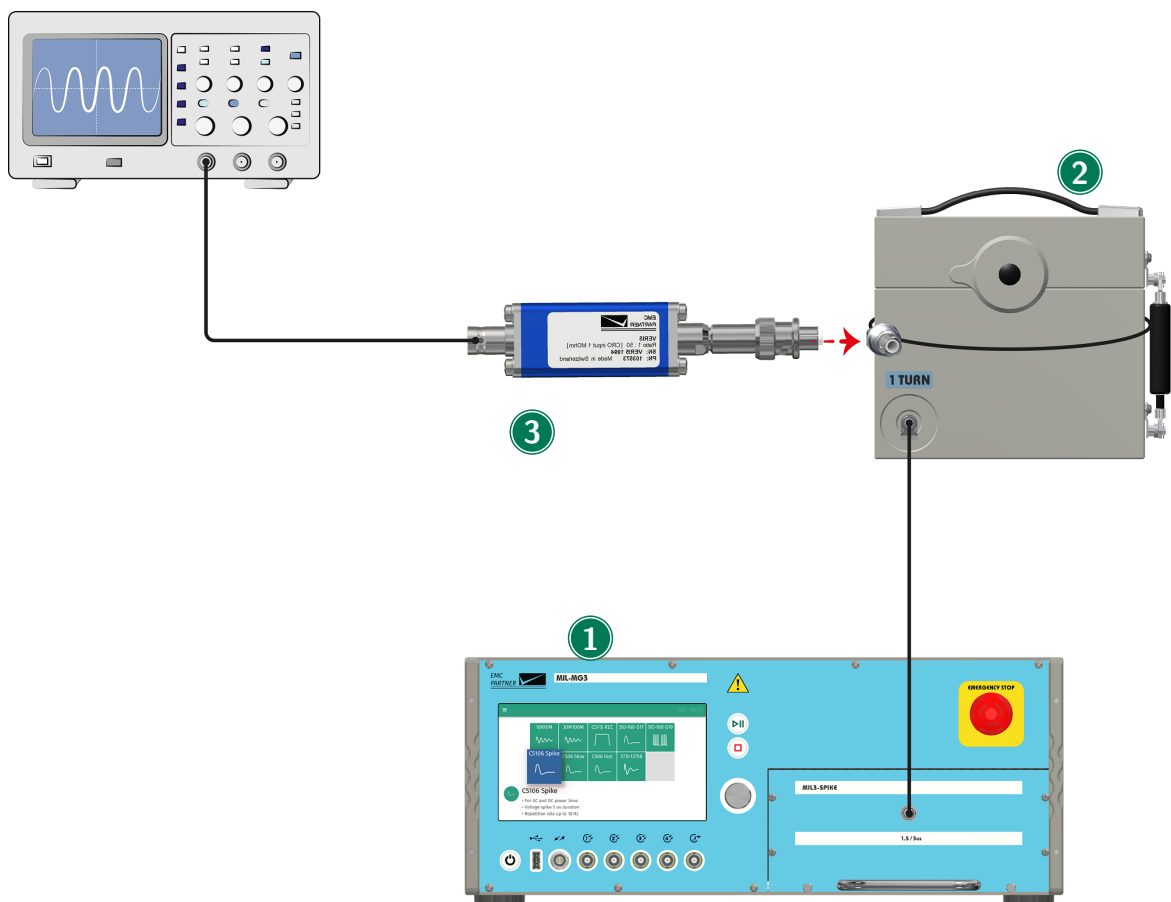

MIL-MG3 - MIL3-SPIKE - CN-MIG-BT5 - VERI5

- ① **Generator**  
The plug-in MIL3-SPIKE has to be fitted in the generator.
- ② **Coupling Device CN-MIG-BT5**  
The output of the plug-in is connected to the 1 Turn input on the back of the CN-MIG-BT5 using the 1m SHV-BNC cable. The 1 Turn Measurement Loop (part of the standard accessory) is placed inside the coupler.
- ③ **Measurement**  
For impedance verification the VERI5 is connected directly to the measurement loop. With the internal voltage divider, the VERI5 can be connected to the oscilloscope. For voltage measurement, a HV-Probe can be used in place of the VERI5.

### 6.3.2 Test Setup

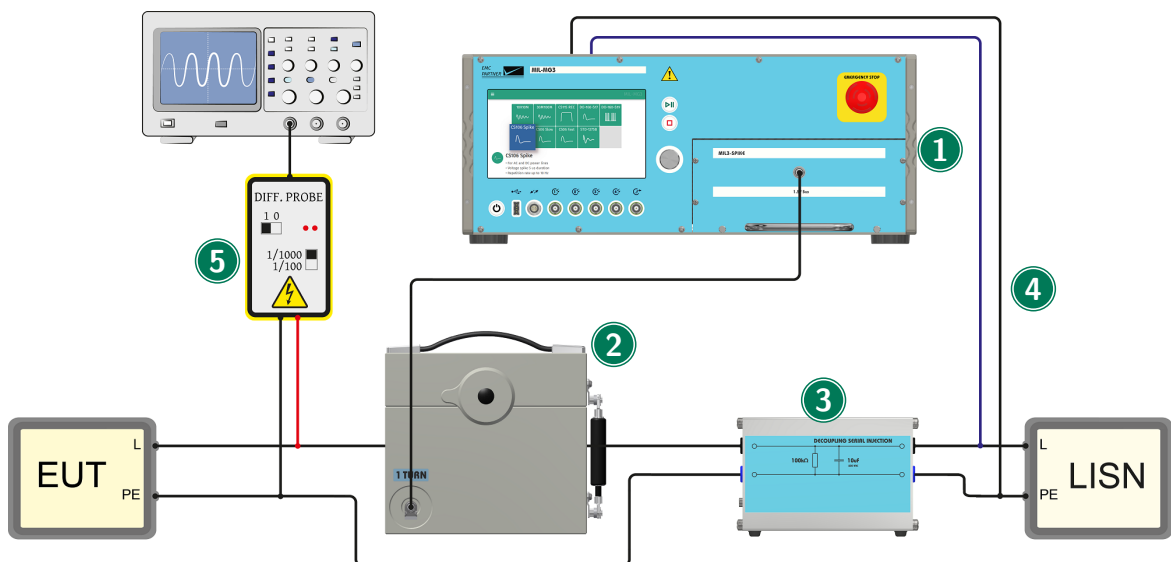

MIL-MG3 - MIL3-SPIKE - CN-MIG-BT5 - DC-S17CL - V-PROBE-SI

- ① **Generator**  
The plug-in MIL3-SPIKE has to be fitted in the generator.
- ② **Coupling Device CN-MIG-BT5**  
The output of the plug-in is connected with the 1 Turn input on the back of the CN-MIG-BT5 using the 1m SHV-BNC cable. The connection line to the EUT is placed through the coupler.
- ③ **Decoupling**  
For decoupling, a 10uF capacitor from the DC-S17CL is placed between the power lines of the EUT.



For 3phase application, the decoupling capacitors have to be installed between all lines. In this case, 3 capacitors are needed. The DC-S17CL has 2 boxes each with 2 x 10uF capacitors.

#### 4 Synchronization

To synchronize impulses with the EUT power supply, the EUT power has to be connected to L and N connectors on the backplane of the MIL-MG3. The connection has to be taken between the DC-S17CL and the power source

#### 5 Measurement

During testing, the voltage waveform can be observed with a HV differential probe.

## 6.4 Test as per MIL-STD-461 CS06 - MIL3-SPIKE-SLOW

### 6.4.1 Serial Injection - Calibration Setup

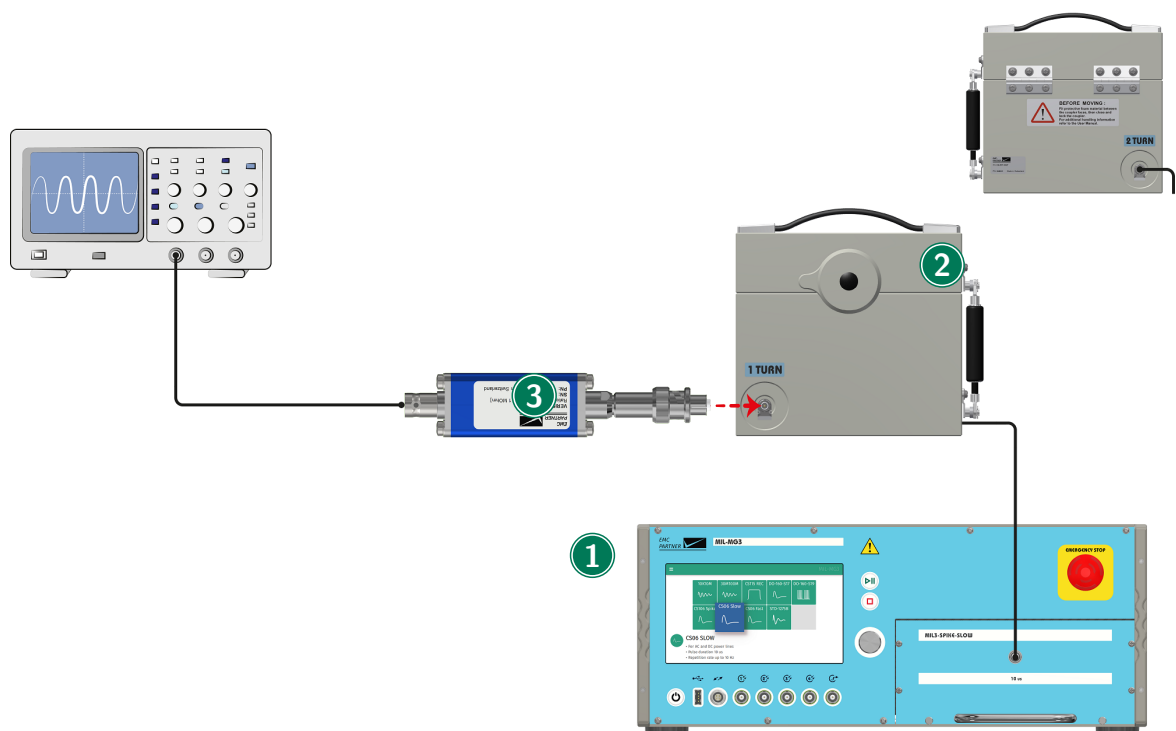

MIL-MG3 - MIL3-SPIKE-SLOW - CN-MIG-BT5 - VERI5 - SHUNT0E1

#### 1 Generator

The plug-in MIL3-SPIKE-SLOW has to be fitted in the generator.

#### 2 Coupling Device CN-MIG-BT5

The output of the plug-in is connected with the 2 Turn input of the CN-MIG-BT5 using a 1m cable.

#### 3 Measurement

For voltage verification the VERI5 is connected directly to the integrated 1 turn loop. The VERI5 can be connected to the Oscilloscope. For current measurement, the SHUNT0E1 can be used in place of the VERI5.



## 6.4.2 Serial Injection - Test Setup

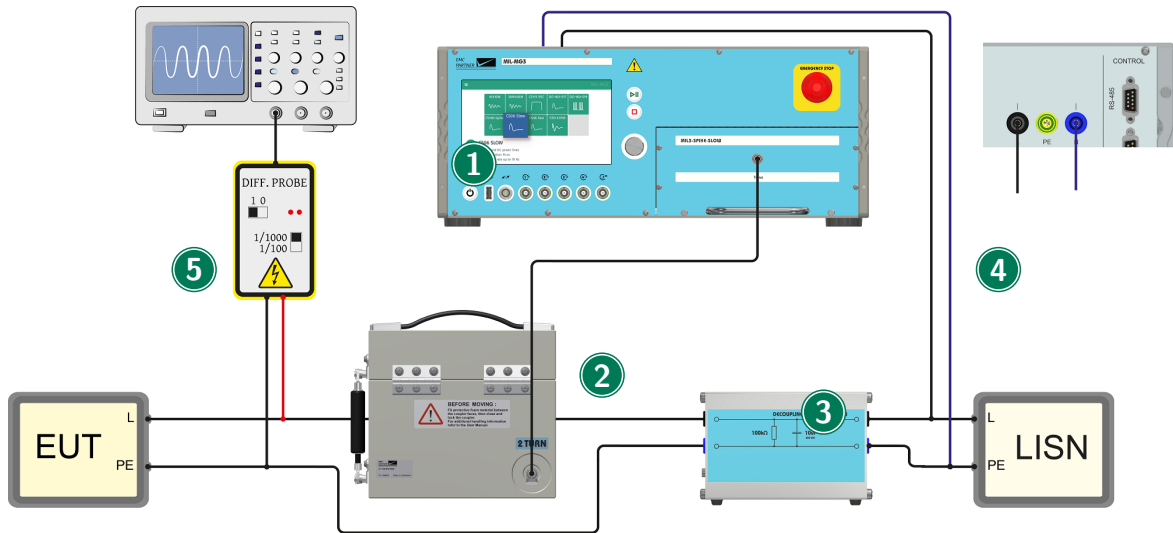

MIL-MG3 - MIL3-SPIKE-SLOW - CN-MIG-BT5 - DC-S17CL - V-PROBE-SI

- 1 Generator**  
The plug-in MIL3-SPIKE-SLOW has to be fitted in the generator.
- 2 Coupling Device CN-MIG-BT5**  
The output of the plug-in is connected with the 2 Turn input of the CN-MIG-BT5 using a 1m cable. The connection line to the EUT is placed directly through the coupler.
- 3 Decoupling**  
For decoupling, a 10uF capacitor from the DC-S17CL is placed between the power lines of the EUT.
- 4 Synchronization**  
To synchronize impulses with the EUT power supply, the EUT power has to be connected to L and N connectors on the backplane of the MIL-MG3. The connection has to be taken between the DC-S17CL and the power source.
- 5 Measurement**  
During testing, the voltage waveform can be observed with a HV differential probe.

### 6.4.3 Parallel Injection - Calibration Setup

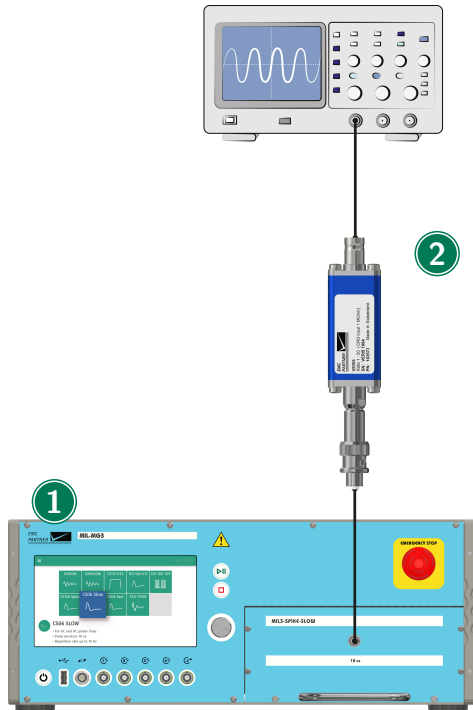

MIL-MG3 - MIL3-SPIKE-SLOW - CN-MIG-BT5 - VERI5 - SHUNT0E1

#### ① Generator

The plug-in MIL3-SPIKE-SLOW has to be fitted in the generator.

#### ② Measurement

For voltage verification the VERI5 is connected directly to the output of the plug-in. The VERI5 can be connected directly to the oscilloscope. For current measurement, the SHUNT0E1 can be used in place of the VERI5.

## 6.4.4 Parallel Injection - Test Setup

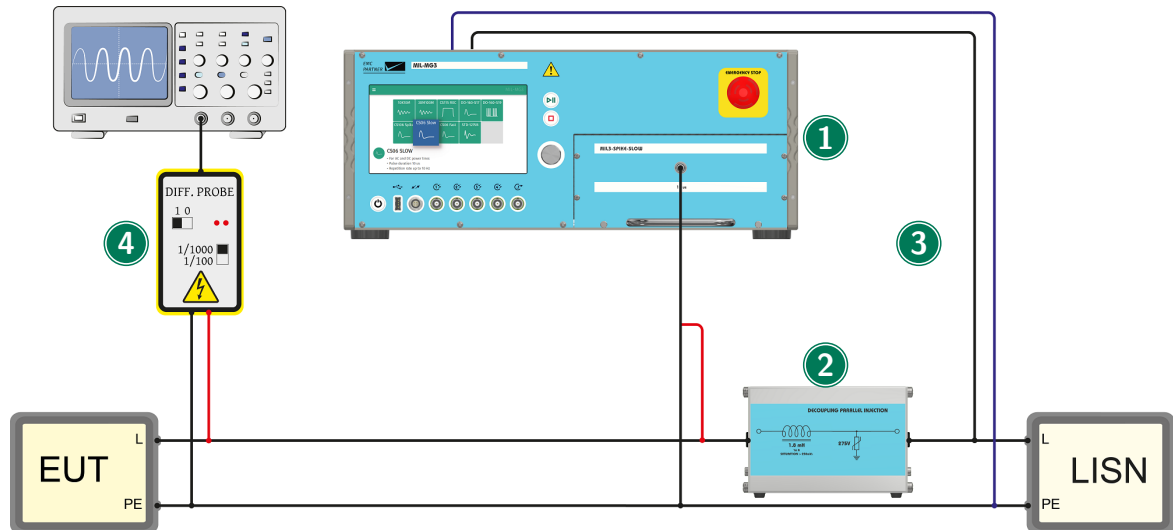

MIL-MG3 - MIL3-SPIKE-SLOW - CN-MIG-BT5 - DC-S17CL - V-PROBE-SI

- ① **Generator**  
The plug-in MIL3-SPIKE-SLOW has to be fitted in the generator.
- ② **Decoupling**  
For decoupling, the decoupling inductor from the DC-S17CL is placed between the injection point and the LISN.
- ③ **Synchronization**  
To synchronize impulses with the EUT power supply, the EUT power has to be connected to L and N connectors on the backplane of the MIL-MG3. The connection has to be taken between the DC-S17CL and the power source
- ④ **Measurement**  
During testing, the voltage waveform can be observed with a HV differential probe.

## 6.5 Test as per MIL-STD-461 CS06 - MIL3-SPIKE-FAST

### 6.5.1 Serial Injection - Calibration Setup

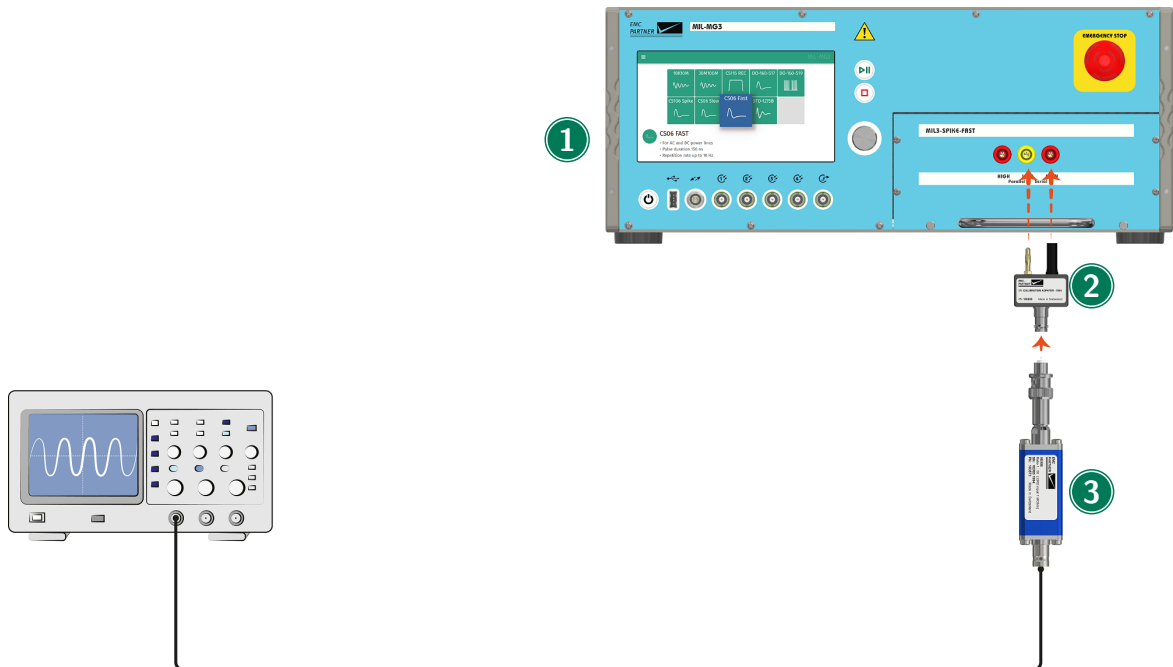

MIL-MG3 - MIL3-SPIKE-FAST - VERI5 - VERI01 OSI

#### ① Generator

The plug-in MIL3-SPIKE-FAST has to be fitted in the generator.

#### ② Measurement Adapter

The measurement adapter (part of the standard accessory) is placed on the right 2 outputs.

#### ③ Measurement

For voltage verification the VERI5 is connected directly to the measurement adapter. The VERI5 can be connected to the Oscilloscope. For current measurement, the VERI01OSI can be used in place of the VERI5.



For current measurement, always use the VERI01OSI. The SHUNT0E1 should not be used as for the MIL-SPIKE or MIL-SPIKE-SLOW. The internal impedance of the SHUNT0E1 is too high and therefore the measured current would be too low.

## 6.5.2 Serial Injection - Test Setup

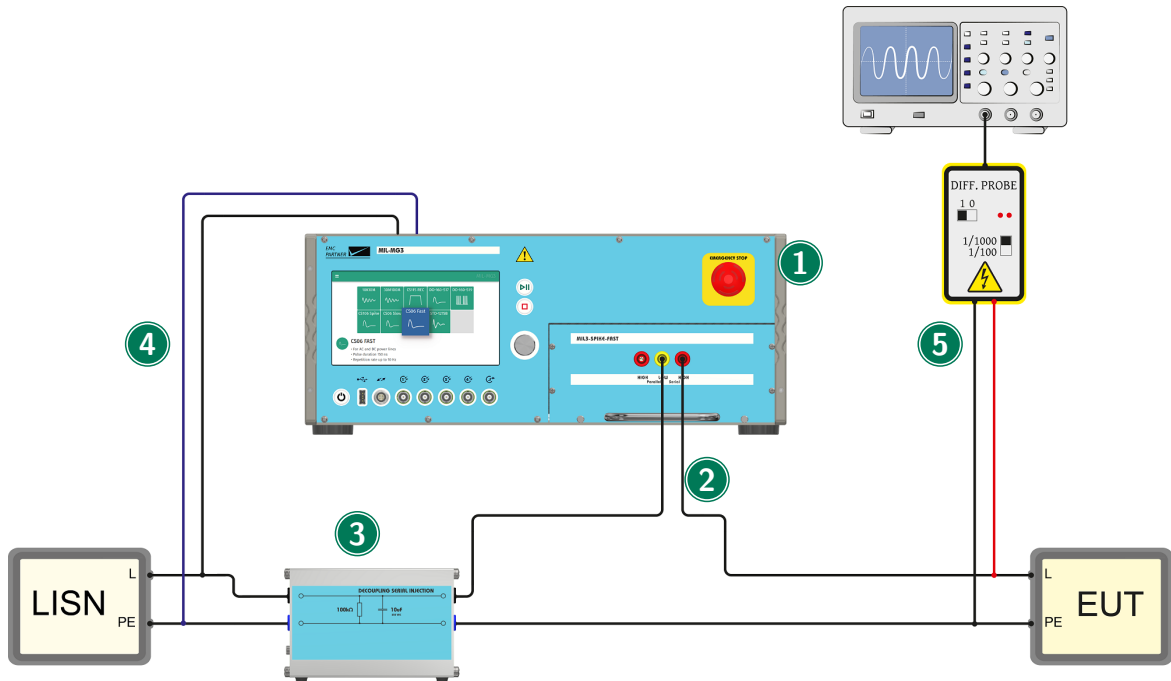

MIL-MG3 - MIL3-SPIKE-FAST - DC-S17CL - V-PROBE-SI

- ① **Generator**  
The plug-in MIL3-SPIKE-FAST has to be fitted in the generator.
- ② **Coupling to EUT**  
The connection line to the EUT is routed through the plugin. The coupling device is integrated.
- ③ **Decoupling**  
For decoupling, a 10uF capacitor from the DC-S17CL is placed between the power lines of the EUT.
- ④ **Synchronization**  
To synchronize impulses with the EUT power supply, the EUT power has to be connected to L and N connectors on the backplane of the MIL-MG3. The connection has to be taken between the DC-S17CL and the power source.
- ⑤ **Measurement**  
During testing, the voltage waveform can be observed with a HV differential probe.

### 6.5.3 Parallel Injection - Calibration Setup

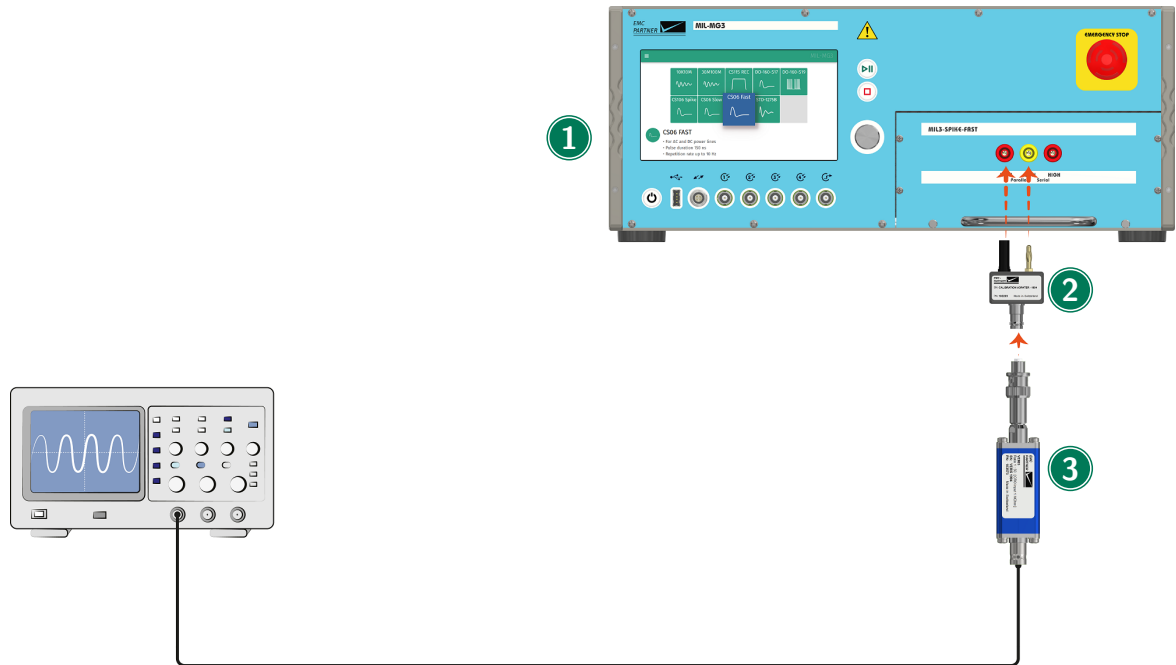

MIL-MG3 - MIL3-SPIKE-FAST - VERI5 - VERI01 OSI

**1 Generator**

The plug-in MIL3-SPIKE-FAST has to be fitted in the generator.

**2 Measurement Adapter**

The measurement adapter (part of the standard accessory) is placed on the left 2 outputs.

**3 Measurement**

For voltage verification the VERI5 is connected directly to the measurement adapter. The VERI5 can be connected directly to the oscilloscope. For current measurement, the VERI01OSI can be used in place of the VERI5.

## 6.5.4 Parallel Injection - Test Setup

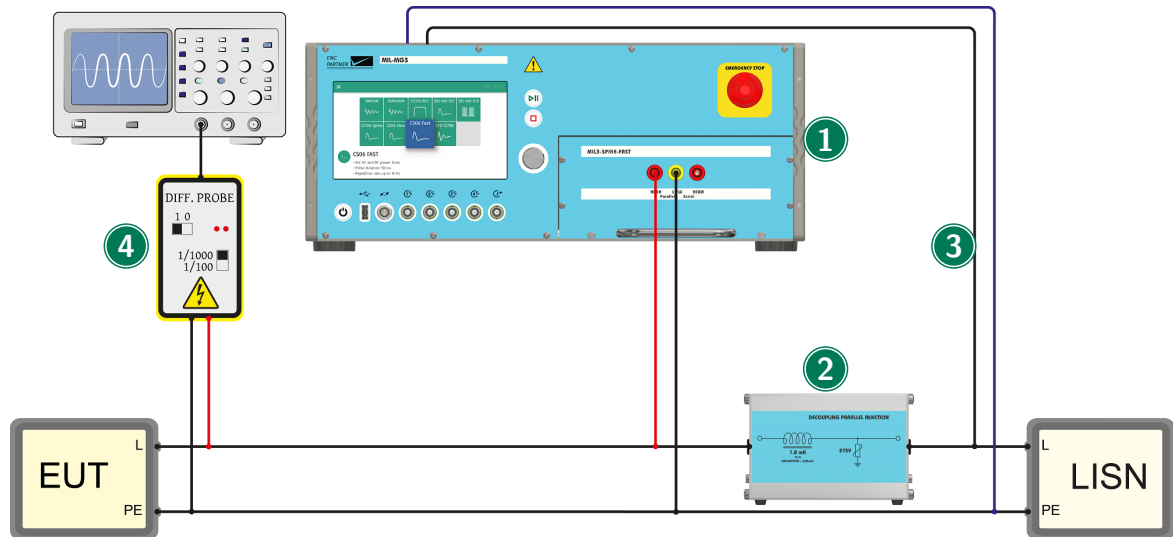

MIL-MG3 - MIL3-SPIKE-FAST - DC-S17CL - V-PROBE-SI

- ① **Generator**  
The plug-in MIL3-SPIKE-FAST has to be fitted in the generator.
- ② **Decoupling**  
For decoupling, the decoupling inductor from the DC-S17CL is placed between the injection point and the LISN.
- ③ **Synchronization**  
To synchronize impulses with the EUT power supply, the EUT power has to be connected to L and N connectors on the backplane of the MIL-MG3. The connection has to be taken between the DC-S17CL and the power source
- ④ **Measurement**  
During testing, the voltage waveform can be observed with a HV differential probe.

## 7 Tests as per MIL-STD-1275B



Additional information for calibration is also available in the calibration report.

### 7.1 Test as per MIL-STD-1275B - MIL3-1275B

#### 7.1.1 Test Setup

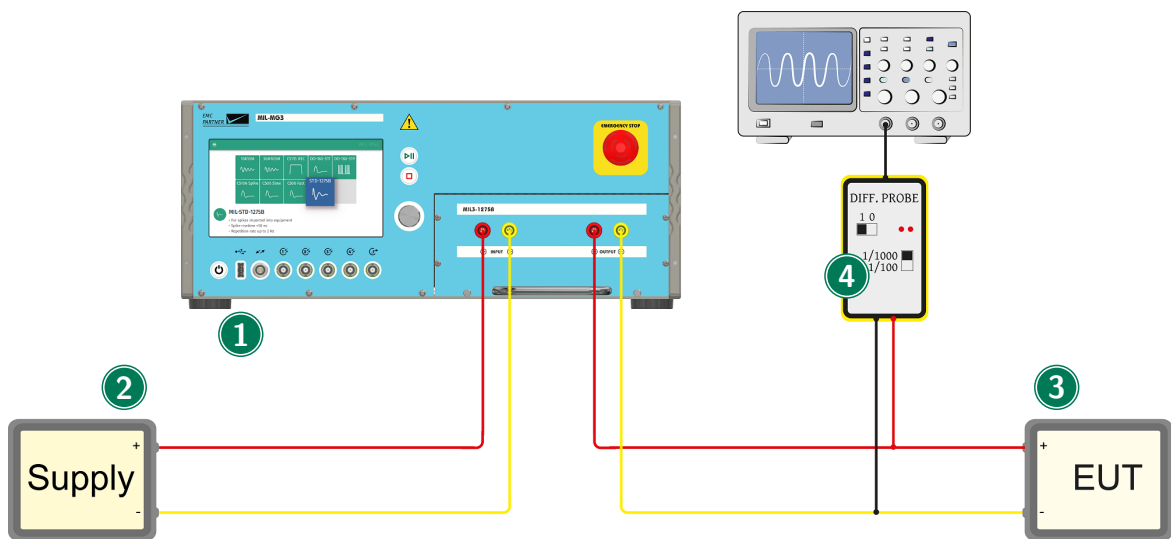

MIL-MG3 - MIL3-1275B - V-PROBE-SI

- ① **Generator**  
The plug-in MIL3-1275B has to be fitted in the generator.
- ② **Power Supply**  
Connect the power supply to the input of the plugin.
- ③ **Power Supply**  
Connect the EUT to the output of the plugin.
- ④ **Measurement**  
During testing, the voltage waveform can be observed with a HV differential probe.



## 8 Tests as per DO160



Additional information for calibration is also available in the calibration report.

### 8.1 Tests as per DO160 Section 17

#### 8.1.1 Serial Injection - Calibration Setup

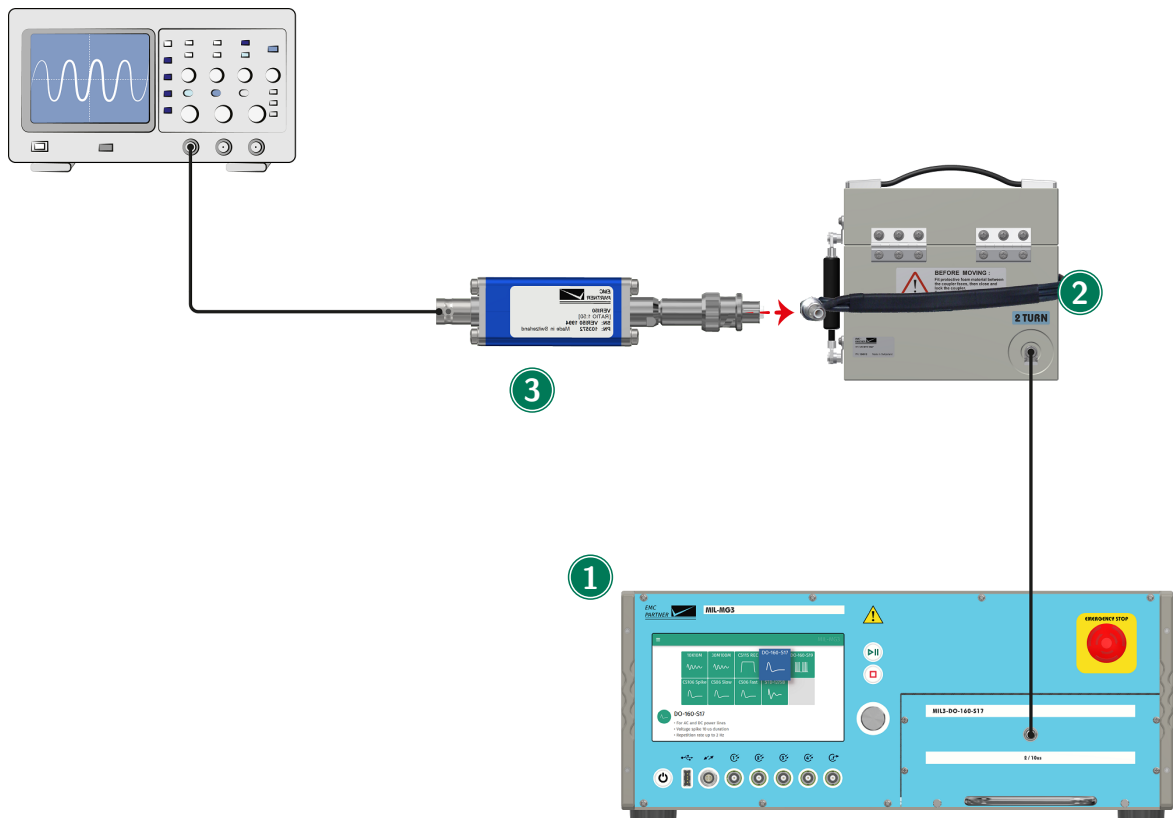

MIL-MG3 - MIL3-DO160-S17 - CN-MIG-BT5 - VERI50

#### 1 Generator

The plug-in MIL3-DO-160-S17 has to be fitted in the generator.

#### 2 Coupling Device CN-MIG-BT5

The output of the plug-in is connected with the 2 Turn input of the CN-MIG-BT5 using a 1m cable. The 3 Turn Measurement Loop (part of the standard accessory) is placed inside the coupler.

#### 3 Measurement

For current verification the VERI50 is connected directly to the 3 turn measurement loop. With the internal voltage divider, the VERI50 can be connected to the Oscilloscope. For voltage measurement, a HV-Probe can be used in place of the VERI50.

## 8.1.2 Serial Injection - Test Setup

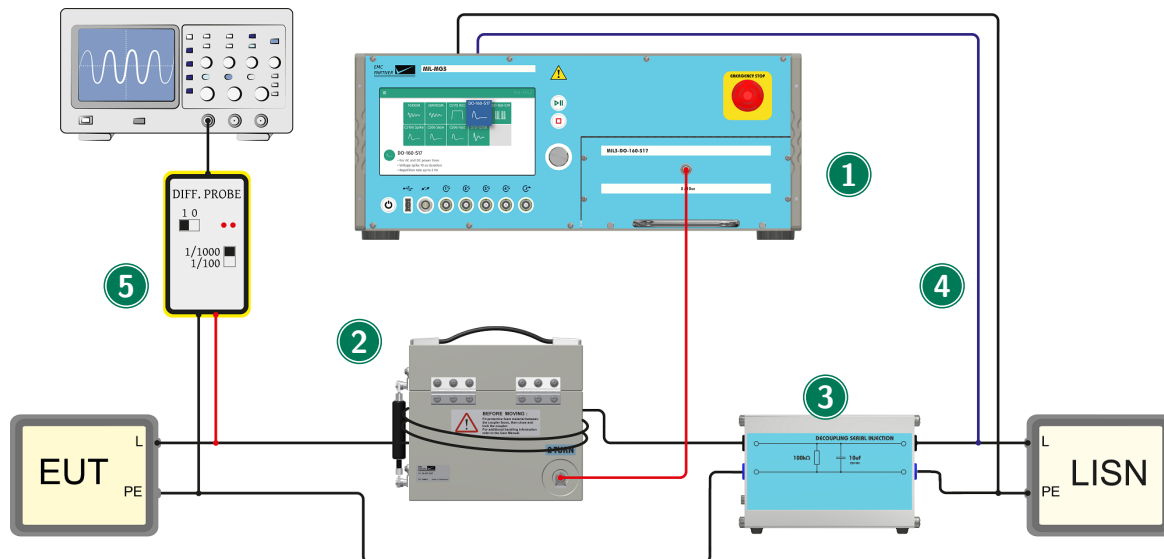

MIL-MG3 - MIL-DO160-S17 - CN-MIG-BT5 - DC-S17CL - V-PROBE-SI

- ① **Generator**  
The plug-in MIL-DO160-S17 has to be fitted in the generator.
- ② **Coupling Device CN-MIG-BT5**  
The output of the plug-in is connected with the 2 Turn input of the CN-MIG-BT5 using a 1m cable. The connection line to the EUT is placed with 3 turns through the coupler.
- ③ **Decoupling**  
For decoupling, a 10uF capacitor from the DC-S17CL is placed between the power lines of the EUT.
  - ⚠ For 3phase application, the decoupling capacitors have to be installed between all lines. In this case, 3 capacitors are needed. The DC-S17CL has 2 boxes each with 2 x 10uF capacitors.
- ④ **Synchronization**  
To synchronize impulses with the EUT power supply, the EUT power has to be connected to L and N connectors on the backplane of the MIL-MG3. The connection has to be taken between the DC-S17CL and the power source.
- ⑤ **Measurement**  
During testing, the voltage waveform can be observed with a HV differential probe.

### 8.1.3 Parallel Injection - Calibration Setup

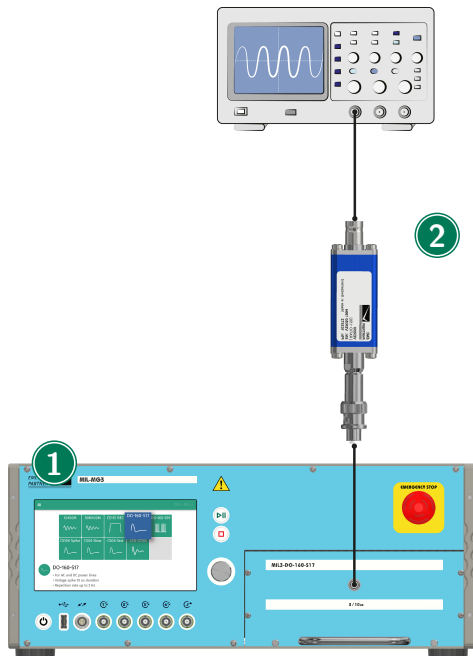

MIL-MG3 - MIL3-DO160-S17 - VERI50

#### ① Generator

The plug-in MIL3-DO-160-S17 has to be fitted in the generator.

#### ② Measurement

For current verification the VERI50 is connected directly to the output of the plugin. With the internal voltage divider, the VERI50 can be connected to the oscilloscope. For voltage measurement, a HV-Probe can be used in place of the VERI50.

### 8.1.4 Parallel Injection - Test Setup

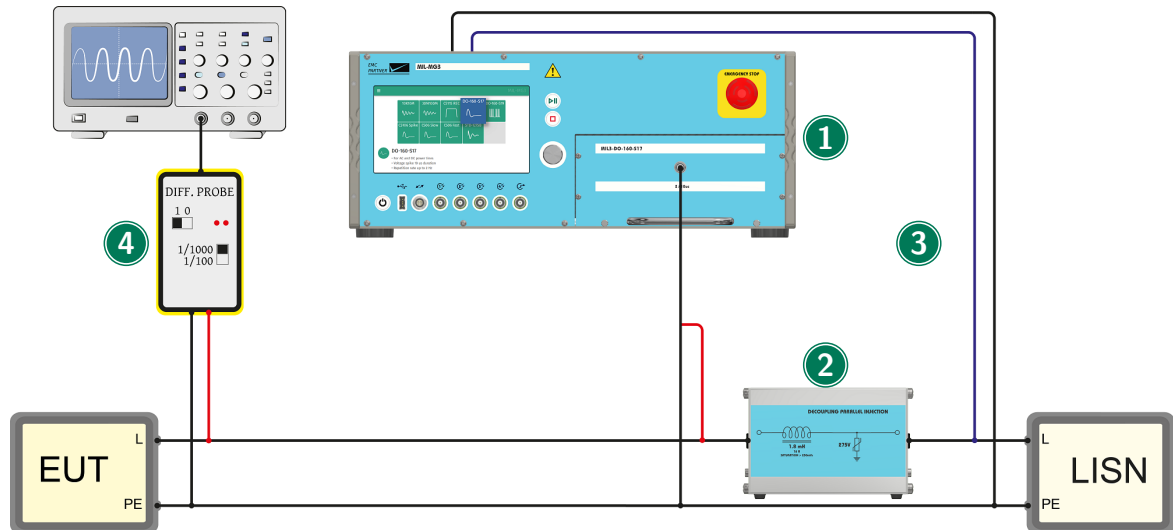

MIL-MG3 - MIL3-DO160-S17 - DC-S17CL - V-PROBE-SI

- ① **Generator**  
The plug-in MIL3-DO-160-S17 has to be fitted in the generator.
- ② **Decoupling**  
For decoupling, the decoupling inductor from the DC-S17CL is placed between the injection point and the LISN..
- ③ **Synchronization**  
To synchronize impulses with the EUT power supply, the EUT power has to be connected to L and N connectors on the backplane of the MIL-MG3. The connection has to be taken between the DC-S17CL and the power source
- ④ **Measurement**  
During testing, the voltage waveform can be observed with a HV differential probe.

## 8.2 Tests as per DO160 Section 19

### 8.2.1 Test Setup

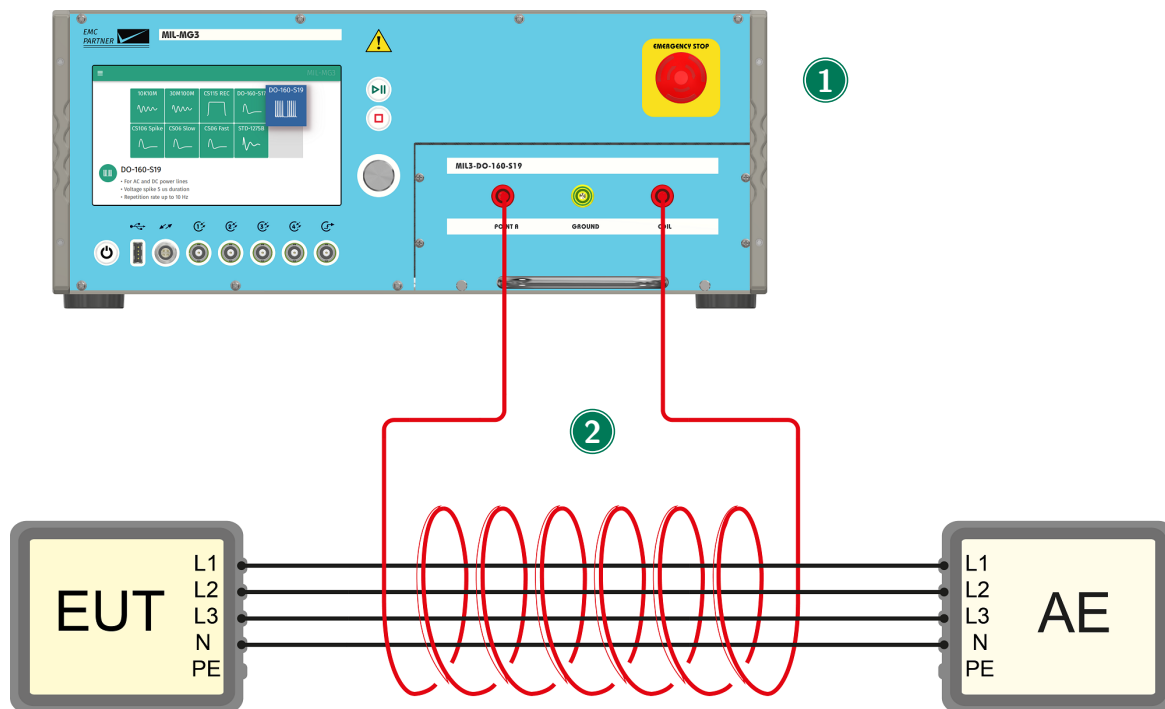

MIL-MG3 - MIL3-DO160-S19

#### ① Generator

The plug-in MIL3-DO-160-S19 has to be fitted in the generator.

#### ② Interconnection wire bundle

Wrap the wire provided around the EUT cable bundle with 3 spirals per meter. Several cables may need to be connected together for longer cable bundles. Connect the spiral wire ends to the plug-in at the connectors marked Point A and Coil.

## 9 Remote Operation

The latest test protocols can be accessed quickly using the internal webserver. Access is through any common web browser and is totally independent of any operating system. In the web browser, enter only the address `http://<ip-address>`



The factory default IP address is 192.168.0.150

A programmer manual is available upon request.

### 9.1 TEMA3000

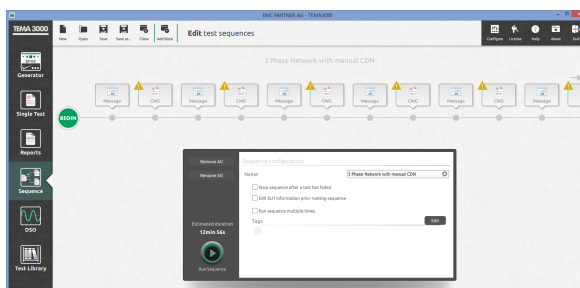

TEMA3000 is a forward looking software suite designed to run on operating systems from Windows 7 and upwards. Graphic user interface with icons to simplify operation. Parameter entry through Remote EMC PARTNER Operating System (REPOS) interface reduces learning time for users familiar with the generator hardware. TEMA3000 base version includes generator remote control interface and single test capability, save and recall of files and a comprehensive help file. Test routines can be prepared in TEMA3000 and then uploaded into the generator in the test lab. Programming with the REPOS interface is exactly the same as sitting in front of a generator. Report generation in TEMA3000 base version is through the Web Server in the generator or the generator USB port.

Main features of TEMA3000 are

- Remote control of generator
- Save single tests
- Combine different tests to a test sequence with pictures about test setups and additional help for test operator
- Outstanding protocol features including export in different file formats
- Easy to use test library with hundreds of tests
- Seamless integration of your DSO

Get in touch with your local representative or directly with EMC PARTNER for more information about TEMA3000.



Go to [www.emc-partner.com](http://www.emc-partner.com) for a free software demo version.

## 10 Maintenance and Service

### 10.1 Firmware update

Keeping test instrumentation up to date is an important part of the product life cycle. EMC PARTNER makes continuous improvements to all products. This can be in the form of hardware changes or software changes. Software updates for all instruments are provided free of charge to existing customers. EMC PARTNER recommends to update the system regularly.

#### Online Update

Select ≡ (Options Menu) -> Update

The easiest way if the generator is connected to the internet. If a newer version is available, the installation is made with a single click.

#### Update via USB

You can also download the newest version from [www.emc-partner.com](http://www.emc-partner.com). Store the update file on a USB-Stick and transfer into the equipment via the USB port on the front panel. The update process starts automatically.



Do not switch off the generator during a firmware update

### 10.2 Maintenance

### 10.3 Cleaning

Cleaning the front and rear panels can be made with small amount of warm soapy water and a soft cloth. The display can be cleaned with a cleaning tissue. EMC PARTNER recommends that the air filter of the ventilator be cleaned from time to time. The cleaning cycle depends on the environmental conditions. Wash out the air filter of the ventilator in soapy water. The air filter must be dried before being reinstalled.

### 10.4 Warranty

EMC PARTNER's warranty is two years from date of invoice for manufacturing defects and one year from date of invoice for consumable parts, e.g. relays, capacitors, variac, connectors. During the warranty period it is EMC PARTNER's goal to repair the equipment within one working week at the service plant in Laufen, Switzerland. However, due to excessive work load or component supply deliveries this repair time may be extended. The warranty on demo equipment is limited in all cases to a maximum period of 2 years after delivery ex works (see EMC PARTNER Invoice date). For sales by sub-resellers or rental companies, the warranty will not be extended. Shipping expenses "Customer to EMC PARTNER" must be paid by customer or reseller. Return shipments "EMC PARTNER to Customer" are sent DAP delivery address using normal road transport for all destinations within Europe or CIP destination airport by airfreight through our house forwarder for all overseas shipments. Additional costs for express delivery must be borne by the customer. Return of EMC PARTNER's equipment for warranty repair is at the sole discretion of EMC PARTNER's Customer service department. An RMA number has to be requested from EMC PARTNER before sending any equipment back to Switzerland. EMC PARTNER reserves the right to reject or invoice repairs on equipment returned for repair without such authorization.

## 10.5 Customer Service

EMC PARTNER is an international organization with designated service centres in all major markets. When any of the following occur:

- Accessories or replacement parts are needed
- Questions arise that are not covered in the user manual
- The equipment must be recalibrated
- The equipment needs repairing

contact the local EMC PARTNER representative or service centre. If the local contact is not known, check the internet site [www.emc-partner.com](http://www.emc-partner.com) and select contacts. If there is no local organization, contact EMC PARTNER headquarters in Switzerland. Our contact details are also given on the web site.

Whenever further assistance is required, provide as much data as possible to help with a speedy solution. Service relevant information (system configuration, error logs, etc.) is collected by the equipment. This information can be very helpful in providing an early solution. Copy service information to a USB memory stick as follows:

- Plug in a USB stick
- Select ≡ (General Menu) → Generator
- In the tab Help select Copy to USB

The information is transferred to the root folder of the USB. Send file by e-mail to [service@emc-partner.ch](mailto:service@emc-partner.ch)

## 10.6 Recycling / Disposal

### RoHS directive 2011/65/EU

The system complies with the directive 2011/65/EU (RoHS - Restriction of certain Hazardous Substances). From December 2005, all EMC PARTNER products either hand soldered or by machine are produced using lead-free solder.

### WEEE directive 2012/19/EU

The system is exempted from the directive 2012/19/EU (WEEE) under category 9. The product should be recycled through a professional organization with appropriate experience for the disposal and recycling of electronic products. EMC PARTNER is also available to help with questions relating to the recycling of this product.

### Dismantling

There is no special danger involved in dismantling.

### Parts which can be recycled

The system contains parts made from steel, aluminium, PVC, two-component sealing compound. The impulse capacitors are filled with non-poisonous mineral oil. The various parts can be separated and recycled.

### Parts which cannot be recycled

None



# 11 Technical Data

## 11.1 MIL-MG3

### 11.1.1 MIL-MG3 Main Generator

<b>Input Power</b>	
Voltage	100 V - 240 V $\pm$ 10 %
Frequency	50 Hz - 60 Hz
<b>Consumption</b>	
Switched off	0 VA
Standby	<15 VA
Test running	max. 150 VA
Dimensions	57 cm x 45 cm x 19 cm
Weight	17 kg
<b>Environmental Conditions</b>	
Temperature	10 °C - 35 °C
Humidity	<80 % non condensing
Pressure	86 kPa - 106 kPa
<b>System</b>	
Display	7" Capacitive Touch
Internal memory	1 GB RAM 4 GB Flash
<b>Connections</b>	
USB	2 * Typ A Plug
LAN	RJ45 Gigabit Ethernet
Trigger Output	BNC max. 6 V
Control Ports	2 x RS485
Auxiliary Connector	Safety Circuit Warning Lamps (24 V / max. 2.4 W)
<b>Emergency Stop</b>	
<b>Multi Purpose Connection</b>	
Frontpanel	4 * BNC
Rearpanel	2 * BNC
Programmable Inputs	Trigger Input Start Test Stop Test EUT Fail EUT Mark Emergency Stop
Input Low Voltage	< 1.5 V
Input High Voltage	> 2.3 V
Max. Input Voltage	24 V
Programmable Outputs	Running State Safety Circuit State
Max. Output Voltage <sup>1</sup>	24 V
Max. Output Current	300 mA

<sup>1</sup>The output functions as open drain output

### 11.1.2 MIL3-REC

<b>Standard</b>	MIL-STD-461 G CS115
<b>Current into 100 Ω</b>	1 A - 10 A ±10 %
<b>Rise time</b>	<2 ns
<b>Fall time</b>	<2 ns
<b>Duration</b>	≥30 ns
<b>Repetition</b>	0.03 s - 60 s
<b>Polarity</b>	positive negative
<b>Coupling</b>	CN-BT6
<b>max. EUT Current</b>	unlimited
<b>Dimensions</b>	45 cm x 21 cm x 9 cm
<b>Weight</b>	2 kg

### 11.1.3 MIL3-10K10M

<b>Standard</b>	MIL-STD-461 G CS116
<b>Frequency</b>	10 kHz ±10 % 100 kHz ±10 % 1 MHz ±10 % 10 MHz ±10 %
<b>Current into 100 Ω</b>	
10 kHz	20 mA - 220 mA ±10 %
100 kHz	0.2 A - 2 A ±10 %
1 MHz	1 A - 12 A ±10 %
10 MHz	2 A - 12 A ±10 %
<b>Damping factor</b>	15 ±5
<b>Repetition</b>	0.5 s - 60 s
<b>Polarity</b>	positive negative
<b>Coupling</b>	CN-BT6
<b>max. EUT Current <sup>2</sup></b>	
50 Hz	160 A
400 Hz	20 A
800 Hz	10 A
<b>Dimensions</b>	45 cm x 21 cm x 9 cm
<b>Weight</b>	3.5 kg

<sup>2</sup>Only if power line and power line return are not routed together through the CN-BT6. Values between can be interpolated.

### 11.1.4 MIL3-30M100M

<b>Standard</b>	MIL-STD-461 G CS116
<b>Frequency</b>	30 MHz $\pm 10\%$ 100 MHz $\pm 10\%$
<b>Current into 100 <math>\Omega</math></b>	
30 MHz	2 A - 12 A $\pm 10\%$
100 MHz	1 A - 6 A $\pm 10\%$
<b>Damping factor</b>	15 $\pm 5$
<b>Repetition</b>	0.5 s - 60 s
<b>Polarity</b>	positive negative
<b>Coupling</b>	CN-BT6
<b>max. EUT Current</b> <sup>3</sup>	
50 Hz	320 A
400 Hz	40 A
800 Hz	20 A
<b>Dimensions</b>	45 cm x 21 cm x 9 cm
<b>Weight</b>	2 kg

### 11.1.5 MIL3-DO160-S17

<b>Standard</b>	DO160 Section 17
<b>Level</b>	50 V - 1200 V $\pm 10\%$
<b>Rise time</b>	<2 $\mu$ s
<b>Duration</b>	>10 $\mu$ s
<b>Impedance</b>	50 $\Omega \pm 10\%$
<b>Repetition</b>	0.5 s - 60 s
<b>Polarity</b>	positive negative
<b>Synchronisation</b>	
<b>Input voltage</b>	50 V to 280 V
<b>Input frequency</b>	40 Hz to 800 Hz
<b>Angle</b>	0° - 359° $\pm 5^\circ$
<b>Coupling</b>	direct (parallel injection) CN-MIG-BT5 (serial injection)
<b>max. EUT Voltage (parallel injection)</b> <sup>4</sup>	
DC - 60 Hz	250 V
>60 - 400 Hz	60 V
>400 - 800 Hz	30 V
<b>max. EUT Current (serial injection)</b> <sup>5</sup>	
50 Hz	1280 A
400 Hz	160 A
800 Hz	80 A

<sup>3</sup>Only if power line and power line return are not routed together through the CN-BT6. Values between can be interpolated.

<sup>4</sup>The current is only limited by the external decoupling element.

<sup>5</sup>Only if power line and power line return are not routed together through the CN-MIG-BT5. Values between can be interpolated. The voltage is not limited.

<b>Dimensions</b>	45 cm x 21 cm x 9 cm
<b>Weight</b>	3.3 kg

### 11.1.6 MIL3-DO160-S19

<b>Standard</b>	DO160 Section 19
<b>Level</b>	>600 V Peak - Peak
<b>Burst Duration</b>	50 $\mu$ s - 1000 $\mu$ s
<b>Spike repetition</b>	0.2 $\mu$ s to 10 $\mu$ s
<b>Burst Repetition</b>	0.1 s - 60 s
<b>Dimensions</b>	45 cm x 21 cm x 9 cm
<b>Weight</b>	3 kg

### 11.1.7 MIL3-SPIKE

<b>Standard</b>	MIL-STD-461 C CS06 MIL-STD-461 F CS106
<b>Level across 50<math>\Omega</math></b>	100 V - 600 V $\pm$ 10 %
<b>Rise time</b>	1.5 $\mu$ s $\pm$ 0.5 $\mu$ s
<b>Fall time</b>	3.5 $\mu$ s $\pm$ 0.5 $\mu$ s
<b>Duration</b>	5 $\mu$ s $\pm$ 22 %
<b>Undershoot Vsag</b>	<120 V @400V
<b>tsag</b>	<20 $\mu$ s
<b>Source Impedance</b>	<2 $\Omega$
<b>Repetition</b>	0.1 s - 60 s
<b>Polarity</b>	positive negative
<b>Synchronisation</b>	
<b>Input voltage</b>	50 V to 280 V
<b>Input frequency</b>	40 Hz to 800 Hz
<b>Angle</b>	0° - 359° $\pm$ 5°
<b>Coupling</b>	direct (parallel injection) CN-MIG-BT5 (serial injection)
<b>max. EUT Voltage</b>	230 V for parallel injection
<b>max. EUT Current <sup>6</sup></b>	
50 Hz	160 A
400 Hz	20 A
800 Hz	10 A
<b>Dimensions</b>	45 cm x 21 cm x 9 cm
<b>Weight</b>	3.1 kg

<sup>6</sup>Only if power line and power line return are not routed together through the CN-BT5. Values between can be interpolated.

### 11.1.8 MIL3-SPIKE-SLOW

<b>Standard</b>	MIL-STD-461 C CS06 ECSS-E-ST-20-07C Rev. 1 (CS power leads transients)
<b>Coupling</b>	direct (Parallel Injection) CN-MIG-BT5 (Serial Injection)
<b>Level into 5 <math>\Omega</math></b>	
Parallel Injection	20 V - 500 V $\pm 10$ %
Serial Injection	20 V - 300 V $\pm 10$ %
<b>Duration</b>	10 $\mu$ s $\pm 20$ %
<b>Source Impedance</b>	
Parallel Injection	<1 $\Omega$
Serial Injection	<2 $\Omega$
<b>Repetition</b>	0.1 s - 60 s
<b>Polarity</b>	positive negative
<b>Synchronisation</b>	
<b>Input voltage</b>	50 V to 280 V
<b>Input frequency</b>	40 Hz to 800 Hz
<b>Angle</b>	0° - 359° $\pm 5$ °
<b>max. EUT Voltage (Parallel Injection)</b> <sup>7</sup>	
DC - 60 Hz	250 V
>60 - 400 Hz	60 V
>400 - 800 Hz	30 V
<b>max. EUT Current (Serial Injection)</b> <sup>8</sup>	
50 Hz	1280 A
400 Hz	160 A
800 Hz	80 A
<b>Dimensions</b>	45 cm x 21 cm x 9 cm
<b>Weight</b>	2.8 kg

<sup>7</sup>The current is only limited by the external decoupling element.

<sup>8</sup>Only if power line and power line return are not routed together through the CN-MIG-BT5. Values between can be interpolated. The voltage is not limited.

### 11.1.9 MIL3-SPIKE-FAST

<b>Standard</b>	MIL-STD-461 C CS06 ECSS-E-ST-20-07C Rev. 1 (CS power leads transients)
<b>Level into 5 Ω</b>	20 V - 400 V $\pm 10$ %
<b>Duration</b>	150 ns $\pm 20$ %
<b>Source Impedance</b> <sup>9</sup>	<5 Ω
<b>Repetition</b>	0.1 s - 60 s
<b>Polarity</b>	positive negative
<b>Synchronisation</b>	
<b>Input voltage</b>	50 V to 280 V
<b>Input frequency</b>	40 Hz to 800 Hz
<b>Angle</b> <sup>10</sup>	0° - 359° $\pm 5$ °
<b>Coupling</b>	Parallel Injection Serial Injection
<b>max. EUT Voltage (Parallel Injection)</b>	250 V
<b>max. EUT Current (Serial Injection)</b>	32 A
<b>Dimensions</b>	45 cm x 21 cm x 9 cm
<b>Weight</b>	2.8 kg

### 11.1.10 MIL3-1275B

<b>Standard</b>	MIL-STD-1275B figure 10
<b>Level</b>	100 V - 1000V $\pm 10$ %
<b>Rise time</b>	<50 ns
<b>Oscillation frequency</b>	100 kHz - 500 kHz
<b>Repetition</b>	0.5 s - 60 s
<b>Polarity</b>	positive negative
<b>max. EUT power</b>	
DC	28 V / 30 A
AC 50 Hz / 60 Hz	115 V / 25 A 230 V / 10 A
<b>Dimensions</b>	45 cm x 21 cm x 9 cm
<b>Weight</b>	3 kg

<sup>9</sup> up to standard test level 200 V

<sup>10</sup>  $\pm 5$ ° up to 400 Hz

## 11.2 CN-BT6

<b>Dimensions</b>	25 cm x 17 cm x 15 cm
<b>Aperture</b>	5 cm
<b>Weight</b>	5 kg

## 11.3 CN-MIG-BT5

<b>Dimensions</b>	22 cm x 22 cm x 20 cm
<b>Aperture</b>	8 cm x 7 cm
<b>Weight</b>	13 kg

## 11.4 VERI-MIL3

<b>Dimension</b>	34 cm x 13 cm x 16 cm
<b>Bandwith</b>	>500 MHz
<b>Weight</b>	4.5 kg

## 11.5 DC-S17CL

<b>Decoupling inductor</b>	
quantity in set	2
<b>Inductance</b>	1.8 mH
<b>Current</b>	max. 16 A
<b>Voltage</b>	max. 250 V ac / dc
<b>Saturation</b>	>250 mVs
<b>Decoupling capacitor</b>	
quantity in set	4 in 2 boxes
<b>Capacitance</b>	10 $\mu$ F
<b>Voltage</b>	max. 250 V
<b>Frequency</b>	max. 800 Hz
<b>Dimension</b>	34 cm x 28 cm x 17 cm
<b>Weight</b>	7 kg

## 11.6 VERI5

<b>Impedance</b>	5 $\Omega$ $\pm$ 2 %
<b>DC Ratio</b>	
50 $\Omega$ DSO Input	1:100 $\pm$ 2 %
1 M $\Omega$ DSO Input	1:50
<b>Tolerance of Insertion Loss</b>	
up to 10MHz	$\pm$ 0.5 dB
up to 40MHz	$\pm$ 3 dB
<b>Max. power dissipation</b>	10 W
<b>Max. pulse voltage</b>	500 V
<b>Dimension</b>	12 cm x 2.5 cm x 2.5 cm
<b>Weight</b>	0.2 kg

## 11.7 VERI50

<b>Impedance</b>	50 $\Omega$ $\pm$ 2 %
<b>Ratio</b>	
50 $\Omega$ DSO Input	1:100 $\pm$ 2 %
1 M $\Omega$ DSO Input	1:50
<b>Tolerance of Insertion Loss</b>	
up to 100MHz	$\pm$ 0.25 dB
up to 400MHz	$\pm$ 3 dB
<b>Max. power dissipation</b>	10 W
<b>Max. pulse voltage</b>	1200 V
<b>Dimension</b>	12 cm x 2.5 cm x 2.5 cm
<b>Weight</b>	0.2 kg



## 11.8 SHUNTOE1

<b>Impedance</b>	0.1 $\Omega \pm 2\%$
<b>DC Ratio</b>	
50 $\Omega$ DSO Input	1:20
1 M $\Omega$ DSO Input	1:10 $\pm 2\%$
<b>Tolerance of Insertion Loss</b>	
up to 10 MHz	$\pm 0.25$ dB
up to 50 MHz	$\pm 3$ dB
<b>Max. Level</b>	
WF2 Impulse	1600 V
WF3 1 MHz Impulse	4500 V
WF3 10 MHz Impulse	5700 V
<b>Dimension</b>	12 cm x 2.5 cm x 2.5 cm
<b>Weight</b>	0.15 kg

## 11.9 VERI01 OSI

<b>Impedance</b>	0.1 $\Omega \pm 2\%$
<b>DC Ratio</b>	
50 $\Omega$ DSO Input	1:20
1 M $\Omega$ DSO Input	1:10 $\pm 2\%$
<b>Tolerance of Insertion Loss</b>	
up to 100MHz	$\pm 0.5$ dB
up to 400MHz	$\pm 3$ dB
<b>Max. Level</b>	6300 V Fast-DOW-Impulse
<b>Max. average Spikes/s</b>	500 @6300 V
<b>Dimension</b>	8.5 cm x 2.5 cm x 2.5 cm
<b>Weight</b>	0.1 kg