

Manual

for Operation



BS 200N100

BS 200N100.1

Electronic switch
for Voltage Transient testing

CABS 200N Load impedance for BS200N100

RS-Box Shunt resistor

R-Box LV124

The BS 200N100 is used to evaluate automotive electrical and electronic components for conducted emissions of transients along battery fed or switched supply lines of a Device Under Test (DUT). A device under test which is considered a potential source of conducted disturbances should be tested according to ISO 7637 part 2. The BS 200N100 and BS 200N100.1 include an electronic switch for repeatable switching of inductive loads as specified in ISO 7637-2:2011 yet supporting former standard editions.

- ISO 7637-1:1990
- ISO 7637-2:1990
- ISO 7637-2:2004
- ISO 7637-2:2011



AMETEK CTS GmbH

Sternenhofstrasse 15
4153 Reinach BL1
Switzerland

Phone : +41 61 717 91 91

Fax : +41 61 717 91 99

URL : <http://www.emtest.com>

Copyright © 2017 AMETEK CTS GmbH

All right reserved.
Specifications subject to change

Contents

1.	Standards covered by BS 200N100	4
1.1.	Maximum applicable dc voltage supply	4
2.	Operating functions	5
2.1.	Operating elements on the top side	5
2.2.	Operating elements Front- and Rearside.....	6
3.	Equipment description	7
3.1.	Electronic switch	7
3.2.	Divider 1:200	7
3.3.	Air cooling.....	7
4.	Technical Data	8
4.1.	Technical data BS 200N100	8
4.2.	Technical data CA BS 200N	9
4.3.	Technical data Shunt resistor RS-Box	10
4.4.	R-Box LV124 Resistor box.....	10
5.	Calibration / Measuring procedure	11
5.1.	Test load CABS 200N	11
5.2.	Test voltage.....	11
5.3.	Switch-Off fall time	11
5.4.	Measuring results.....	12
5.4.1.	Voltage drop in dependence of the test load	12
5.4.2.	Measuring results with verification set-up as per Standard	12
5.4.3.	Verification.....	12
6.	Maintenance	13
6.1.	General.....	13
6.2.	Calibration and Verification	13
6.2.1.	Factory calibration	13
6.2.2.	Guideline to determine the calibration period of EM Test instrumentation	13
6.2.3.	Calibration of Accessories made by passive components only:	13
6.2.4.	Periodically In-house verification.....	13
7.	Application	14
7.1.	Test setup ISO 7637-2 Ed.3 (2011)	14
7.2.	LV 124 Test E-10 short interruption Text case 3	16
8.	Delivery Groups	17
8.1.	Basic equipment.....	17
8.2.	Options.....	18
9.	Appendix	19
9.1.	Declaration of CE-Conformity	19
9.2.	BS 200N100 - Overview.....	20
9.3.	CA BS - Overview	21

1. Standards covered by BS 200N100

With the BS 200N100 the user covers the following standards for conducted emission transients:

- **ISO 7637-2** Ed3 (2011-03) Road vehicles; Electrical disturbances by conduction and coupling ;
Part 2 : Electrical transients conduction along supply lines only
- **several standards** In accordance with ISO 7637 Part 2
- **LV 124** Elektrische und elektronische Komponenten in Kraftfahrzeugen bis 3,5t
- Allgemeine Anforderungen, Prüfbedingungen und Prüfungen

1.1. Maximum applicable dc voltage supply



The **maximum applicable DUT dc voltage supply** for the BS 200N100 is **60V DC**

Higher dc voltages will **damage** the equipment.

2. Operating functions

2.1. Operating elements on the top side

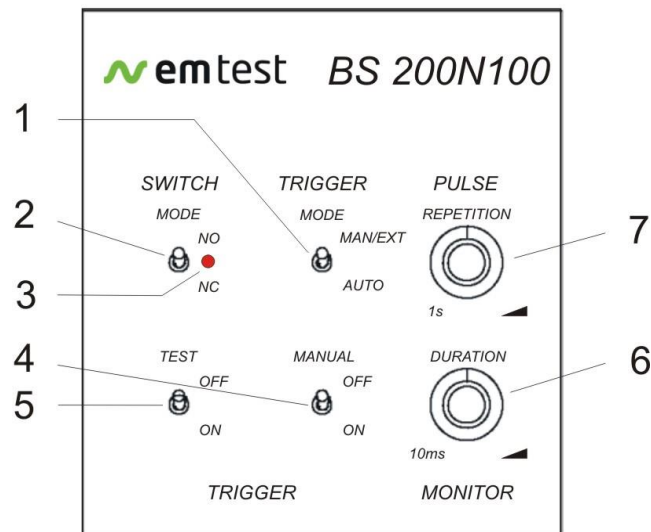

Figure 2.1 : BS 200N100 Top side

- | | | | |
|---|--|---|---|
| 1 | Switch Trigger mode :Manual or Ext. / Auto | 5 | Switch TEST ON / OFF |
| 2 | Switch operating mode (normal open / closed) | 6 | Potentiometer Pulse duration 10ms ...>500ms |
| 3 | LED Switch closed | 7 | Potentiometer Pulse repetition 1s...>5s |
| 4 | Button MANUAL Trigger | | |

1 Trigger Mode

Trigger release selection of the BS 200N100 switch:

MAN / EXT : The trigger is released by manual operation with the button MANUAL, or via an external trigger signal at the BNC plug EXT.

AUTO : After switch TEST ON button, the BS 200N100 switch starts to work.

2 Switch Mode

Setting of the switch mode:

- **NO** : (Normally Open) The switch is normally open and close at each event.
- **NC** : (Normally Closed) The switch is normally closed and opens at each event.

3 LED Switch closed

The LED is lighted during the switch is closed.

4 Manual Trigger

Select "Manual trigger" mode of the switch. (open and closing time depends the time setting)

- **OFF** : Initial state
- **ON** : One switch event is released.

5 TEST

On / Off switch for start the electronic switch:

- **OFF** : Switch out of service (switch status depends on setting NC or NO).
- **ON** : Switch in operation (open and closing time depends the time setting).

6 Pulse Duration

Potentiometer for adjust the switch duration.
Range: 10ms ... > 500ms \pm 5%

7 Pulse Repetition

Potentiometer for adjust the repetition time.
Range: 1s ... > 10s \pm 5%

2.2. Operating elements Front- and Rearside



Figure 2.2: BS 200N100 view left and right side

- | | | | |
|---|------------------------------|---|-------------------------------|
| 1 | Power IN + | 6 | BS200N100 Power supply 24V DC |
| 2 | Input DUT supply - IN | 7 | Output to DUT + |
| 3 | Monitor DUT output 1:200, 5% | 8 | Output to DUT - |
| 4 | Trigger OUT (15V neg. slope) | 9 | Reference earth connection |
| 5 | Trigger IN (Pull down) | | |

1 Power IN + supply

The battery supply + IN for the DUT is connected to this input. The switch is located between POWER +IN and DUT + plug. The nominal dc supply parameters are 60V / 100A .

2 Power IN - supply

The battery supply - IN for the DUT is connected to this input. Internal is a direct connection to DUT- plug.

3 Monitor DUT

Monitor output for voltage measuring (divider 200:1, 5%). The monitor measures the voltage at the DUT side. The BNC output plug is isolated.

For transient emission measuring an external voltage probe with >400MHz bandwidth must be used.

4 CRO Trigger OUT

Trigger output for an oscilloscope trigger. Trigger with a negative slope (+15V to 0V).

5 Trigger IN

The Trigger IN (Umax. +15V) has two different modes

1. External trigger input for start a single switch event using the duration, setting with the potentiometer. The trigger shall be a zero going signal (BNC to GND).

2. Direct switch control ON/OFF (LV124 application)

The trigger controls direct the switch. This happens normally with the PFS 200 generator trigger out signal. For set the BS 200N100 in this mode, the user must press during the power on time the **“Manual Trigger”** button. A short LED blinking confirms the correct setting.

6 Power supply device 24V DC

Input plug for 24V dc supply 1A.

7 Output to DUT +

The DUT is connected at the banana output sockets **OUT +**.

8 Output to DUT -

The DUT is connected at the banana output sockets **OUT -**.

9 Reference earth connection

The bottom plane is the reference GND of the BS 200N100 and must be connected to the ground reference plane.

3. Equipment description

The Switch BS 200N100 is designed with the following main components:

- Electronic switch
- Differential Voltage divider 200:1

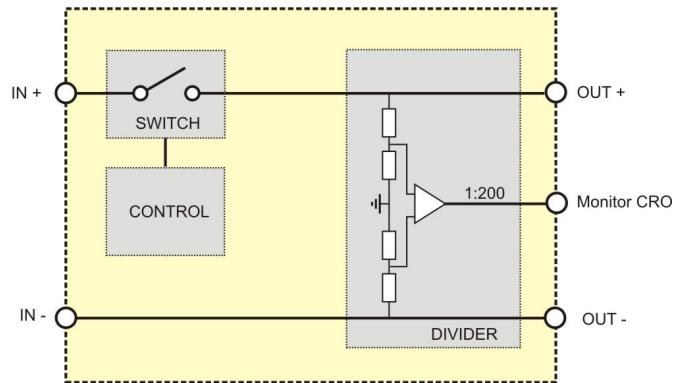

Figure 3.1. : General diagram BS 200N100

3.1. Electronic switch

The electronic Switch has 2 operating modes:

NC : Normally Closed

NO : Normally Open

Figure 3.2 shows the both operating modes with the variable parameters “Repetition” and “Duration”

The electronic switch disconnects the DUT from battery supply voltage for a specified time in a well specified and reproducible manner.

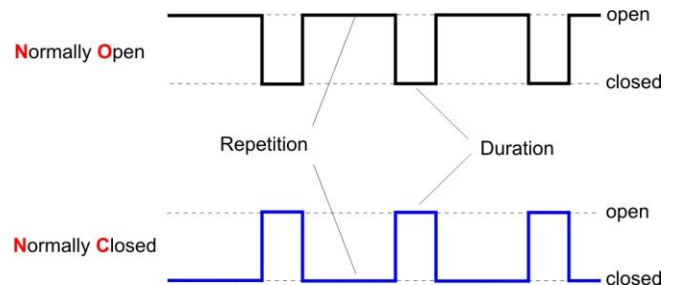

Figure 3.2. : Operating modes Switch BS 200N100

The electronic switch is activated by pushing the button **TEST**. The red LED indicates the closed status.

In **AUTO** mode the electronic switch is triggered internally with the preselected repetition rate. In **MANUAL** mode a single switching event is triggered either by pushing the **MANUAL** button or by remote trigger.

The electronic switch can switch currents up to 100A and is able to withstand voltages up to 1000V.

The electronic switch is protected against overload and can withstand short-circuit conditions.

Specific protection requirements of the EUT must be separately assured by the user.

Inrush currents

Inrush currents up to 500A are permitted.

Overvoltage

The switch is protected against over voltages higher than 1000V by internal varistors.

3.2. Divider 1:200

The built in differential divider is designed to monitor the supply voltage. The measuring signal is available on the **MONITOR** BNC plug. The 10MHz bandwidth is not designed for measuring the transient emission. The standard recommends an external voltage probe for this measurement.

The divider is an ohmic- capacitive differential divider with a 50Ω terminating resistor to the BNC plug.

3.3. Air cooling

The BS200N100 has internal air ventilation for cooling the battery supply switch. Ventilation grid and ventilator (blower) must be kept away from other devices in order to allow sufficient air flow through the battery supply switch.

4. Technical Data

4.1. Technical data BS 200N100 and BS 200N100.1

Test voltage	
Operating voltage	Max. 60 V
Operating current	Max. 100 A continuous
Peak current protection	500 A
Inrush current	400 A for 200 ms
Voltage drop	Less than 0.2 V @ 25 A Less than 1.2 V @ 100 A
Peak voltage	Typ. 1300 V
Overvoltage protection	By varistor
Overload protection	short – circuit over temperature protected switch off after approx. 2 min with 120 A; switch on after approx.. 45 s cooling time.
Inverse polarity protection	Protected with an additional acoustic signal in case of inverse polarity
Electronic switch	
Switching time	300 ns $\pm 20\%$ (240 ns – 360 ns) into test load 50 μ H/0.6 Ω
On/Off duration	Min. 10 ms to 500 ms continuously selectable by potentiometer $\pm 5\%$
On/Off repetition	Min. 1 s to 10 s continuously selectable by potentiometer $\pm 5\%$
Operation	Switch closed indicated by LED
Output noise	< 400 mV peak, (typical 300 mV)
Trigger	
Manual	Manual trigger of a single event
Auto	Automatic trigger with min. ~ 0.1 Hz to max. 1 Hz repetition, continuously selectable by potentiometer
Extern	External trigger $\downarrow 0V$, BNC input (U _{max.} +15 V)
External LV124 Mode	Active when Manual Trigger button is pressed during “Power ON”
Trigger delay typical	Switch off: approx. 10.5 μ s Switch on: approx. 94 ms
Measurement	
Voltage monitor	BNC output; differential divider 1:200, $\pm 5\%$; Bandwidth 10 MHz
CRO trigger	BNC output, $\downarrow 0 V$
General data	
Output connector	50mm above GND plane
Connector DUT	6mm high current connector 100 A, 4 mm safety lab connectors 32 A
Dimensions	90 mm x 125 mm x 120 mm (L x W x H);
Weight	1.30 kg
Supply voltage	24V DC via mains supply adapter

Power Supply adapter BS200N100	
Model	GE24I24-P1J
Input Voltage	90 → 264V ac
Output Voltage	24V dc
Output Current	1A
Power Rating	24W
Package Plug	Top
Type	Switch Mode
Dimensions	81x43x40.5mm
Efficiency	85%
MTBF	100 khrs
Load Regulation	±3%
Ripple and Noise	240 mV p-p
Line Regulation	±1%
Operating Temperature	-10 → +50°C
Weight	134g
Plug Type	CH/AUS, EURO, UK, USA
ErP Compliance	ErP level V
Number of Outputs	1

4.2. Technical data CA BS 200N

Test voltage	
Battery supply voltage	28Vdc max.
Load current	50A max.
Operating time	13.5V supply approx.1 hour 28.0V supply approx. 10 minutes
Overheat indication	LED
Protection	Switch Off by over temperature sensor
Cooling	Forced air temperature controlled

Impedance	
Load	0.6 Ω in series with 50μH selectable with bridge (R/L)
Parallel load resistor	10Ω, 20Ω, 40Ω, 120Ω selectable with bridge

General data	
Dimensions	19"/ 3HU 154 x 448 x 505mm
Weight	18.35 kg
Mains supply	100V to 230V ac 50/60Hz
Fuse	1A slow blow
Cable	2 x 0.45m, red and black 6mm ² , each 0.125kg



4.3. Technical data Shunt resistor RS-Box

RS-Box				
Resistances	10Ω, 20Ω, 40Ω, 120Ω			
Accuracy	<5%			
Impedance	10Ω	20Ω	40Ω	120Ω
Max. EUT voltage	30V	30V	50V	60V
Max. EUT current	3A	1.5A	1.25A	0.5A
Max. power	90W	45W	62.5W	30W
Cooling	passive			
Max Temperature	30V continuous		approx. 50deg max.	
	50V continuous		approx. 90deg max.	

General data

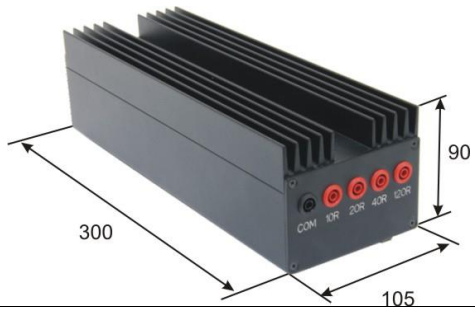
Dimensions	300 x 105 x 90mm (L x W x H)			
				
Weight	1.70kg			

4.4. R-Box LV124 Resistor box

Resistance	0.1Ω	10kΩ	100kΩ
Max. Spannung	60V	60V	60V
Load at Vmax.		continuous	continuous
Max. load	5W 10 min 10W 5 min		

General Data

Dimension	150 x 80 x 80mm (L x W x H)		
			
Weight	0.45 kg		

5. Calibration / Measuring procedure4

5.1. Test load CABS 200N

The test impedance CABS 200N, a test load with 0.6Ω in series with $50 \mu\text{H}$ inductor, is designed for verification the BS 200N100 acc. ISO 7637-2 standard.

Test load => R (total) = $0,6 \Omega$ in series with
 L (total) = $50 \mu\text{H}$ (1 kHz)

Both R and L also include the variations of the cable and the structure. The parallel capacity which cannot be avoided is approx. 50pF .

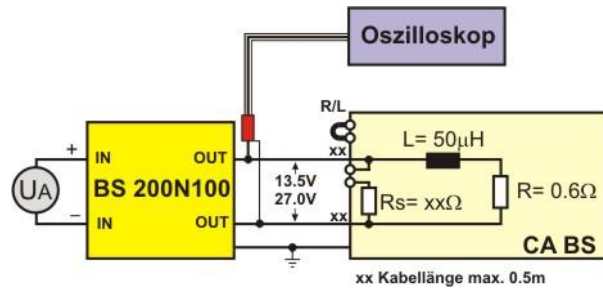

Figure 5.1. : Verification setup



Figure 5.2.: Verification setup

5.2. Test voltage

According to the standard the switch-Off time should be determined under varying test voltages, such as

Va: $U1 = 13.5\text{V}$ and $U2 = 27\text{V}$

Consequently, constant currents of 22.5A or 45A must be considered. The resulting energy consumption at the test load is:

DC Supply	Power 0.6Ω
13.5 V	304 W
27.0 V	1215 W

5.3. Switch-Off fall time

The switch-Off fall time is specified as follows (90% to 10%):

ISO 7637 (old version ≤ 1992) $t_f = 200 \dots 400\text{ns}$
 ISO 7637-2: 2011 and DIN 40839 part 1 $t_f = 300\text{ns} \pm 20\%$ specified at 13.5V only

The resulting transients of the BS 200N100 are measured with a 1:200 voltage probe under loaded condition according the standard. The voltage probe is directly connected to the + and – output of the generator.

5.4. Measuring results

5.4.1. Voltage drop in dependence of the test load

DUT current	Nominal voltage drop	voltage drop (typical value)
1 A	≤ 2.0	0.01 V
5 A	≤ 2.0	0.04 V
10 A	≤ 2.0	0.07 V
25 A	≤ 2.0	0.17 V
50 A	not specified	0.35 V
100 A	≤ 1.0 EM Test specs.	0.96 V

→ Specification values (measured between Power IN+ und DUT+)

5.4.2. Measuring results with verification set-up as per Standard

All measuring values indicated as well as the curve illustrated have been recorded with a serial model.

Reference values measured with BS 200N100

Input Voltage: 13.5 V
 Output Voltage: 13.30 V
 Upeak: - 1030 V
 tf (90% - 10%): 327.4 ns

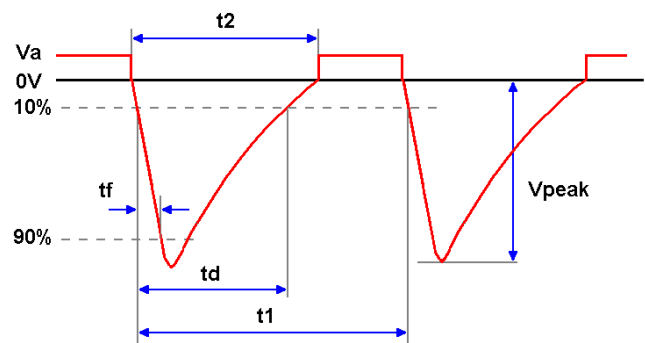

Figure 5.3. : Pulse parameter

5.4.3. Verification

Verification as per ISO 7637-2 Ed3 (2011-03) is defined at 13.5V only. Verification must be performed with calibration load CABS: 0.6Ω in series with 50μH; Rshunt not used

Verification with CABS	Va output voltage	tf 90% - 10% fall time
With standard load	+13.5V ±10%	300ns ±20%

Function	Setting
Switch Mode	NO / NC
Trigger Mode	Man.Ext / Auto
Manual	OFF / ON
Test	OFF / ON
Pulse Repetition	1s
Pulse Duration	10ms

Example for the switch off impulse

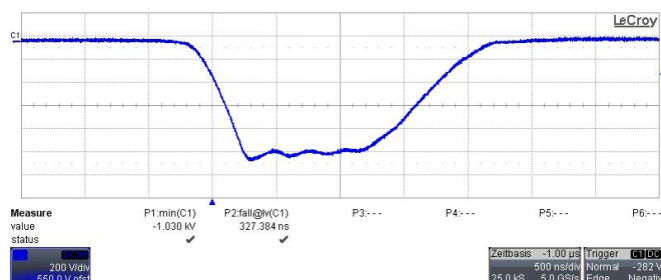

Figure 5.4.: Test load at 13.5V

6. Maintenance

6.1. General

The internal semiconductor switch does not need any maintenance.

6.2. Calibration and Verification

6.2.1. Factory calibration

Every EM TEST generator is entirely checked and calibrated as per international standard regulations before delivery. A calibration certificate is issued and delivered along with a list of the equipment used for the calibration proving the traceability of the measuring equipment. All auxiliary equipment and accessories are checked to our internal manufacturer guidelines.

The calibration certificate and the certificate of compliance (if available) show the date of calibration.

The EM Test product is calibrated in the factory and marked with a calibration mark.

The used measuring instruments are traceable to the Swiss Federal Office of Metrology.

The calibration interval is to the responsibility of the user's quality system. Neither the certificate of calibration nor the corresponding label mark any due date for re-calibration.



Example: Calibration mark

6.2.2. Guideline to determine the calibration period of EM Test instrumentation

Our International Service Departments and our QA Manager are frequently asked about the calibration interval of EM TEST equipment.

EM TEST doesn't know each customer's Quality Assurance Policy nor do we know how often the equipment is used and what kind of tests are performed during the life cycle of a test equipment. Only the customer knows all the details and therefore the customer needs to specify the calibration interval for his test equipment.

In reply to all these questions we like to approach this issue as follows:

EM TEST make use of a solid state semiconductor switch technique to generate high voltage transients. A precious advantage of this technique is the absolute lack of periodical maintenance effort. In consequence, thereof a useful calibration period has to be defined based on two criteria:

- The first one is the customer's Quality Assurance Policy. Any existent internal regulation has to be applied at highest priority. In the absence of such internal regulation the utilization rate of the test equipment has to be taken into consideration.
- Based on the experience and observation collected over the years **EM TEST recommends a calibration interval of 1 year** for frequently used equipment. A 2-years calibration interval is considered sufficient for rarely used test generators in order to assure proper performance and compliance to the standard specifications.

6.2.3. Calibration of Accessories made by passive components only:

Passive components do not change their technical specification during storage. Consequently, the measured values and the plots stay valid throughout the storage time. The date of shipment shall be considered as the date of calibration.

6.2.4. Periodically In-house verification

Please refer to the corresponding standard before carrying out a calibration or verification. The standard describes the procedure, the tolerances and the necessary auxiliary means. Suitable calibration adapters are needed. To compare the verification results, EM Test suggests to refer to the waveshape and values of the original calibration certificate.

7. Application

7.1. Test setup ISO 7637-2 Ed.3 (2011)

Important

- The artificial network AN shall be connected directly to the ground reference plane.
- All wires between AN and the DUT shall be isolated from the ground plane by 50mm.
- The DUT will be placed on the ground plane as in real installation.
 - directly grounded to the ground plane or
 - 50mm isolated from the ground plane
- The position of the instruments shall be as specified in the standard.

Switch as per ISO 7637-2:2011

For the measurement of the emission the ISO 7637-2: 2011 standard defines two different switches and switch positions. These are pending from the rise time of the voltage impulse. The switch position for slow impulses in the ms range is before the electrical switch see figure 7.1. For fast impulses, in μs and ns range, the switch is on the DUT side figure 7.2. During the examination, only one switch may be operated.

For the emission measurement ISO 7637-2: 2011 defines the test setup below. EM Test propose the test setup illustrated in figure 7.1, 7.2 and 7.3.

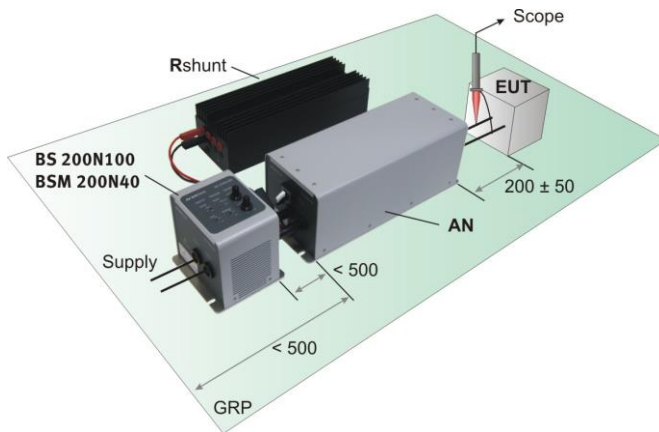

Figure 7.1.: Setup for pulses in the ms range

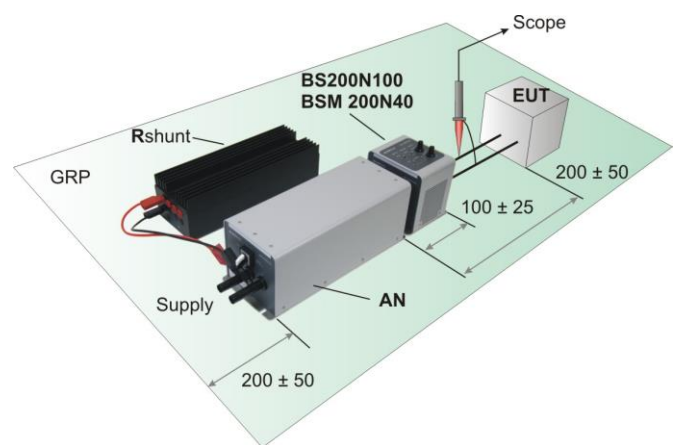

Figure 7.2.: Setup for pulses in the μs / ns range

Setup for DUT with internal Switch

ISO 7637-2:2011 offers a new test setup as shown in figure 7.3 for measuring the transient emission using DUT with internal switch.

This setup is for measuring the transient emission pulses in ns to us range. Cause the existing original switch inside the DUT, it is not necessary to use the BS200N100 in the setup. The shunt resistor R_s is to use as per clause 5.2 of the ISO 7637-2 standard.

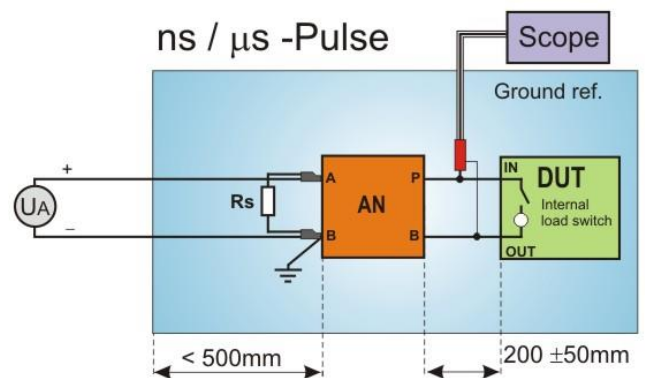

Figure 7.3: Setup for DUT with internal switch for μs / ns pulses

Electronic Switch for pulses below 400V

Inside the BS 200N100 the electronic switch is built in. A clear determination of a disturbance is possible only if an electronic switch with reproducible characteristics is used. For the measurement of the pulses under 400V an electronic switch is recommended (ISO7637-2:2011). The BS200N100 can be used up to 1000V pulses

In order to determine the amplitude and wave shape of a transient, first use the test set-up shown in figure 7.1 for determine the maximum amplitude of the slower impulses (ms range). In the next procedure use test setup as shown in figure 7.2 for measure the maximum amplitude of the fast transients.

Switch for voltage impulses higher than 400V special in μs / ns range

The switch affects in particular the characteristics of the fast transient ones substantially. Besides gladly high amplitudes arise with fast pulses, which can be limited by the protection device of the electrical switch. Therefore, the standard recommends to use the **original switch** how it is used in the vehicle as switching device for pulses in μs / ns range. If such a device is not available, an automotive relay with the following characteristics shall be used:

- contact rating, $I = 30$ A, continuous, resistive load;
- high purity silver contact material;
- no suppression across relay contact;
- single/double position contact electrically insulated from the coil circuit;
- coil with transient suppression.

The switching relay shall be replaced if significant contact degradation occurs.

Resistor R_s

A shunt resistor of 40Ω shall simulate the dc impedance of other connected consumers in the cable tree. According to ISO/DIN 7637 when measuring transient overvoltage, a shunt resistor of 40Ω is required, whereas when measuring transient overcurrent, a shunt resistor of 2Ω is required. For this purpose, an external resistor of $2.5\Omega / 400\text{ W}$ (at 30 V DC) respective 40Ω must be connected in the test circuit. (Figures 7.1., 7.3 and 7.3.)

7.2. LV 124 Test E-10 short interruption Text case 3

The LV124 is a cooperated standard of all German car manufacturers. The application note AN 213 describes in detail the tests with E-10 and E-13. The following chapter describes the test using the BS200N100

EM Test proposal for Test case 3 with 0.1Ω resistor

This proposal is not exact as it is in the LV 124 standard, because the 0.1Ω resistor is only during the interruption time in the circuit. This disadvantage allows the using of smaller dc sources. It is not necessary to drive a constant 110A current into the 0.1Ω resistor.

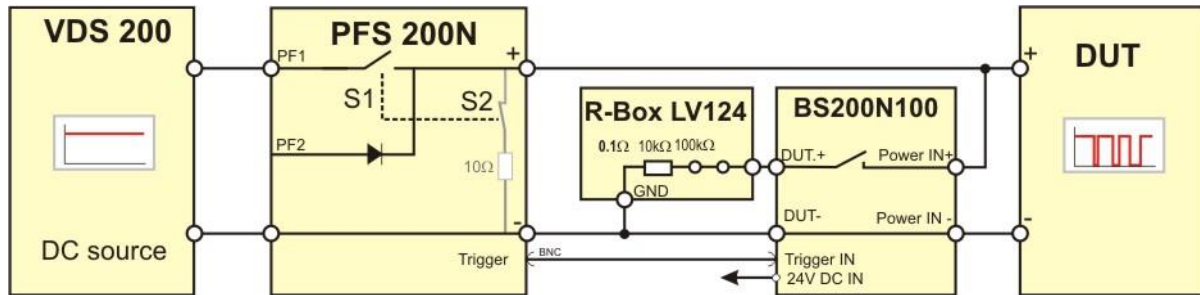

Figure 7.4: EM Test proposal for test setup for test case 3

Test setup and cabling

DUT is connected wired with the PFS200 and BS200N100 as shown in figure 7.4.

Cabling

- + pole (PFS200N) to DUT +
- DUT+ to Power IN+ (BS200N100)
- DUT+ (BS200N100) to Input (R-Box LV124, Box set to 0.1Ω)
- GND (R-Box LV124) to - pole (PFS200)
- DUT- (BS200N100) to - pole (PFS200)
- DUT- to Power IN- (BS200N100)

BNC cable: PFS200 trigger to Trigger IN (BS200N100).

Settings on BS200N100:

- Switch Mode: NO Normally Open
- Trigger Mode: MAN / Ext.
- Duration: Synchronous with trigger signal PFS200 (Power ON BS200N100 as per note below)
- Test: ON

Power ON BS200N100: The BS200N100 must work synchronous with the trigger IN signal. For set the BS200N100 into the LV 124 mode, the user must press the **“Manual Trigger”** button during connect the power to the BS 200N100. A short LED blinking with an acoustic beep confirms the correct LV 124 mode. The potentiometer time setting is disabled in this mode.

Function BS200N100

The Trigger IN controls the ON / OFF position of the switch. The trigger signal is generated from the PFS200 power fail generator.



Figure 7.5: R-Box LV124

8. Delivery Groups

8.1. Basic equipment

- Switch BS 200N100
- Mains cable
- Manual on USB memory stick
- Calibration certificate



Figure 8.1.: BS 200N100

- Mains adapter 24V dc
- Plug Type CH/AUS, EURO, UK, USA



Figure 8.2.: Supply adapter

- 4 connection clamps for assembling
- 2 connection bridge 6mm BS200N100 to AN 200N100 with junction 4mm to a load resistor R_s



Figure 8.3 connectors

Identical accessory parts are delivered only once if several devices are ordered. The delivered packing list is in each case valid for the delivery.

8.2. Options

- **CA BS** calibration load 50uH 0.6Ω
 Delivery : Mains cable
 2x connection cable (45cm)
 2x Short circuit bridges



Figure 8.4. CA BS

- **AN 2050N** Artificial Network for Automotive
 LISN Impedance : As per ISO 7637-2
 Impedance : 5μH - 50Ω
 Current: 50A continuous, 100A short-time



Figure 8.5.: AN 2050N

- **AN 200N100** Artificial Network
 LISN Impedance : As per ISO 7637-2, ISO 11452-2
 CISPR16-1-2, CISPR 25
 Impedance : 5μH - 50Ω
 Current: 100A continuous



Figure 8.6.: AN 200N100

- **Shunt resistor Rs**
 Shuntresistor for simulate the resistance of other vehicle devices which are connected in parallel to the DUT. The standard ISO 7637-2 defines the shuntresistor Rs.
RS-Box 10Ω, 20Ω, 40Ω, 120Ω max. 60V (30V)



Figure 8.7. RS-Box

- **R-Box LV124**
 Resistor box for LV124 E 10
 Resistors: 0.1Ω, 10kΩ und 100kΩ
 Voltage: 60V continuous for 10kΩ and 100kΩ
 Max load 0.1Ω: 5W 10 min, 10W 5 min



Figure 8.8.: R-Box LV124

9. Appendix

9.1. Declaration of CE-Conformity

Manufacturer: **AMETEK CTS (Switzerland) GmbH**
 Address: Sternenhofstr. 15 CH 4153 Reinach
 Switzerland

declares, that under its sole responsibility, the product's listed below, including all their options, are conformity with the applicable CE directives listed below using the relevant section of the following EC standards and other normative documents.

Product's name: Switch
 Model Number(s) BS 200N100
 BS 200N100.1
 CA BS
 RS-Box
 R-Box LV124

Low Voltage Directive 2014/35/EU

Standard to which conformity is declared:

EN 61010-1: 2011 Safety requirements for electrical equipment for measurement, control, and laboratory use.

EMC Directive 2014/30/EU

Standard(s) to which conformity is declared:

EN 61326-1: 2013 Electrical equipment for measurement, control and laboratory use Class A
 EN 61000-3-2: 2014 Limits for harmonic current emissions
 EN 61000-3-3: 2013 Limitation of voltage changes, voltage fluctuations and flicker in public low-voltage supply systems.

European representative
 AMETEK CTS Germany GmbH
 Lünenerstr. 211
 D 59174 Kamen
 Tel: +49 (0) 2307 / 26070-0
 Fax: +49 (0)2307 / 17050

Manufacturer
 AMETEK CTS GmbH
 Sternenhofstr. 15
 CH 4153 Reinach
 Tel: +41 61-7179191
 Fax: +41 61-7179199



By A. Gerstner
 General manager
 Place Kamen, Germany
 Date 1. July 2017

A. Burger
 Business Manager Conducted EMC
 Reinach BL, Switzerland
 1. July 2017

9.2. BS 200N100 - Overview

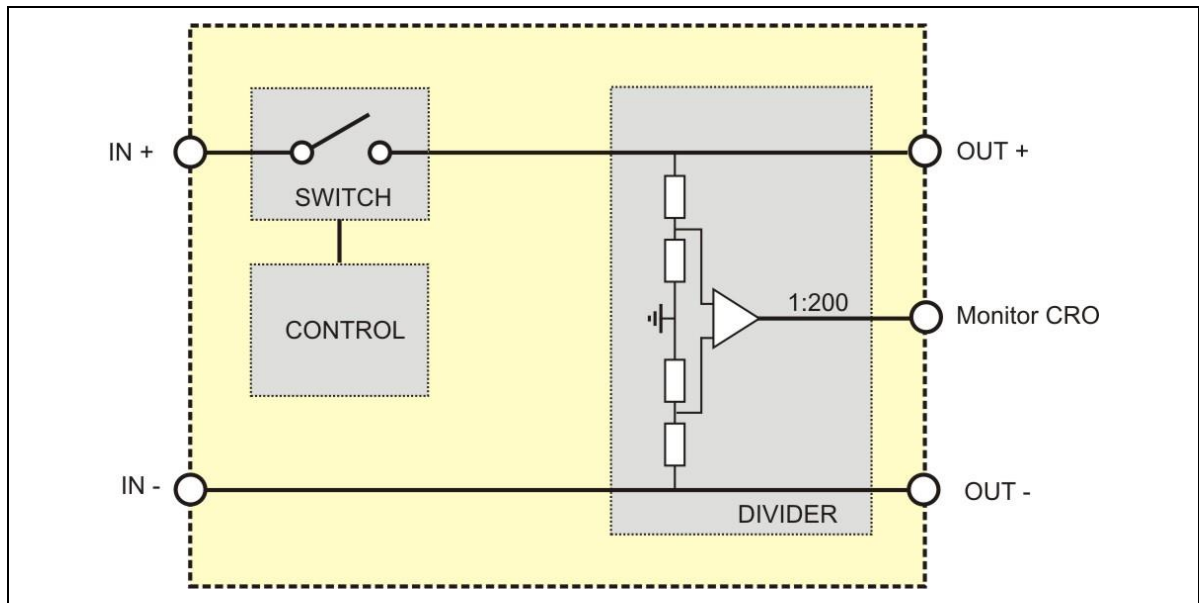
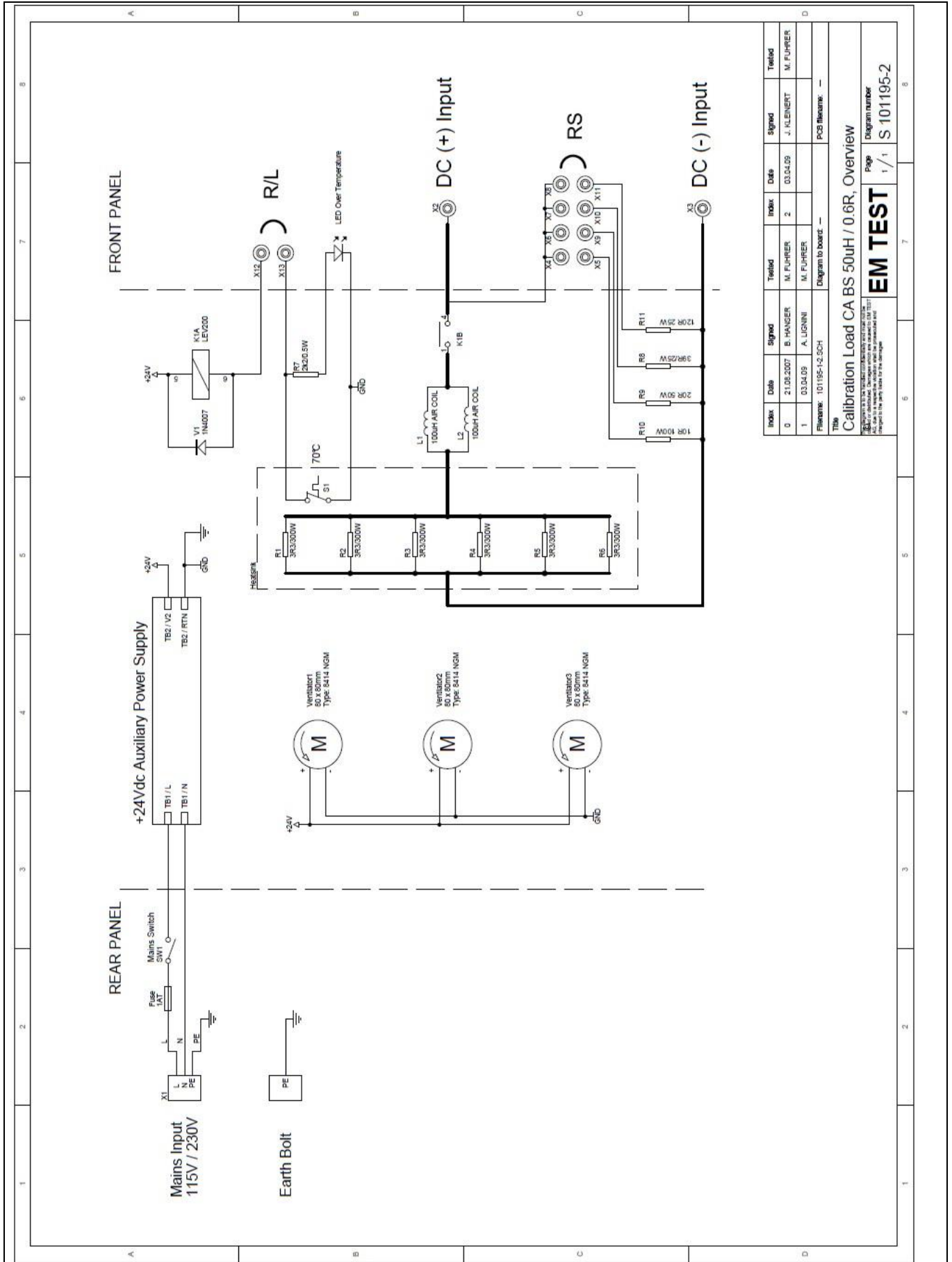

Figure 9.1.: Overview BS 200N100

9.3. CA BS - Overview



Index	Date	Signed	Tested	Index	Date	Signed	Tested
0	21.08.2007	B. HANSEN	M. FUHRER	2	03.04.09	J. KLEINERT	M. FUHRER
1	03.04.09	A. LIGNINI	M. FUHRER				

Filename: 101195-1-2 SCH
Diagram to board: --
PCB filename: --

Title
Calibration Load CA BS 50uH / 0.6R, Overview

EM TEST

Page 1 / 1
Diagram number S 101195-2

Fig 9.2.: Overview CA BS