

# Instruction Manual



## esd NX30 esd NX30.1

### ESD Simulator

Electrostatic discharges either from a human body to any other part or between two different objects can cause persistent disturbances or even destruction to sensitive electronics or controls. esd NX30 is an ESD tester to simulate ESD pulses at higher voltages up to 30 kV in both air and contact discharge mode. It therefore satisfies requirements exceeding the EN/IEC 61000-4-2 test levels and complies to automotive test applications.

- IEC 61000-4-2
- EN 61000-4-2
- ISO 10605



## Table of Contents

<b>ESD Simulator</b> .....	<b>1</b>
<b>Table of Contents</b> .....	<b>2</b>
<b>1 EXPLANATION OF THE SYMBOLS USED IN THIS MANUAL</b> .....	<b>4</b>
<b>2 SAFETY</b> .....	<b>5</b>
<b>3 INTRODUCTION</b> .....	<b>6</b>
3.1 Electrostatic discharge (ESD) .....	6
3.2 Simulation .....	6
3.3 Effects on the EUT .....	7
<b>4 THE esd NX30 SYSTEM</b> .....	<b>8</b>
4.1 The simulator .....	8
4.1.1 Function modules.....	9
4.1.2 Block diagram .....	9
4.1.3 Operating elements.....	10
4.2 System components .....	10
4.2.1 Battery charger / power supply unit .....	11
4.2.2 Options.....	11
4.2.3 R/C Discharge Networks.....	11
4.2.4 Remote triggering (esd NX30 only) .....	12
4.2.5 Interlock (esd NX30 only) .....	13
<b>5 COMMISSIONING</b> .....	<b>15</b>
5.1 Function test .....	15
<b>6 OPERATION</b> .....	<b>16</b>
6.1 Switching on.....	16
6.2 Battery monitoring (esd NX30 only) .....	16
6.3 Operation and settings.....	16
6.3.1 Display mode .....	17
6.3.2 Voltage .....	17
6.3.3 Polarity .....	17
6.3.4 Counter .....	18
6.3.5 Repetition.....	19
6.3.6 Discharge Network.....	19
6.3.7 DUT Discharge Mode .....	19
6.3.8 Settings .....	21
6.3.9 Program .....	21
6.3.10 Activity Log.....	21
6.3.11 Language .....	21
6.3.12 Device info .....	21
6.3.13 Threshold .....	23
6.3.14 Display Settings .....	23
6.3.15 ISO-Selftest.....	23
6.3.16 Continuous operation.....	24
6.4 The Home Screen.....	24
6.4.1 Quick Start .....	24
6.4.2 Standards.....	24
6.4.3 Test Levels.....	24
6.4.4 Test Routines.....	25
<b>7 TEST PROCEDURES</b> .....	<b>26</b>
7.1 Standard-compliant procedures.....	26
7.2 Other situations .....	26
<b>8 TYPICAL PULSE DATA</b> .....	<b>28</b>
<b>9 MAINTENANCE</b> .....	<b>29</b>
9.1 Calibration.....	29

---

9.2	Exchanging the R/C network .....	29
9.2.1	Reduction of the pulse repetition rate through higher capacitance .....	29
9.3	Repairs.....	29
9.4	esd NX30 system error messages.....	30
9.5	Disposal .....	30
<b>10</b>	<b>TECHNICAL SPECIFICATIONS .....</b>	<b>32</b>
11	CE-certificate of compliance .....	33
<b>Low Voltage Directive 2014/35/EU.....</b>		<b>33</b>

## 1 EXPLANATION OF THE SYMBOLS USED IN THIS MANUAL

Please take note of the following explanations of the symbols used in order to achieve the optimum benefit from this manual and to ensure safety during operation of the equipment.

The following symbol draws your attention to a circumstance where non-observation of the warning could lead to inconvenience or impairment in the performance.

Example:



This connection must not be confused with the main power input.

The following symbol draws your attention to a circumstance where nonobservation of the warning could lead to component damage or danger to the operating personnel.

Example:



Never connect or disconnect the pistol while system is performing a test.

Symbols used on the product:



**Danger  
high voltage**



**Protective  
earth terminal**



**Attention  
refer to manual**

## 2 SAFETY



### WARNING

This item of equipment, together with its accessories, works at high voltages of up to 30 kV. Any careless handling or non-observance of the operating instructions may result in dangerous consequences.

The esd NX30 simulator is not a toy! It is a professional tool and belongs only in the hands of specialists and appropriately trained personnel.

When powered by its own batteries the generator can be active even without any power cable being connected.

The instrument must not be switched on unless a correctly connected earth or earth cable (pulse current return path) is in place. The original earth cable supplied with the instrument is to be used. Any replacement cables must be fabricated in such a way that they cannot be accidentally connected to a mains outlet socket. Do not touch the discharge tip! There is a danger of an unpleasant electric shock if the instrument is switched on (LCD display active).



### ATTENTION

Only trained personnel may operate the instrument.



### WARNING

Personnel fitted with a heart-pacemaker must not operate the instrument nor approach the test rig while it is in operation.

These operating instructions form an integral part of the instrument and must be available to the operating personnel at all times. The instrument must not be used for any purpose other than testing the ESD immunity of electronic equipment.

The construction of the simulator is not designed for use in an explosive environment.



### WARNING

Each electrostatic discharge produces powerful electromagnetic interference. Nearby electronic equipment can be seriously disrupted unless the appropriate counter-measures are taken. Perform ESD tests preferably in a shielded room.



### ATTENTION

If a network needs to be exchanged, the test has to be stopped first, followed by a waiting time of at least 5 s to ensure the voltage being internally discharged.

The rechargeable batteries in the base station (esd NX30 only) must not be short-circuited under any circumstances. They must only be recharged with the original charging unit supplied with the generator. Should they have to be replaced, kindly observe the relevant recommendations for their correct disposal.

The instrument must not be opened. Repairs, maintenance work and internal adjustments are only to be carried out by a qualified service engineer.

Use the instrument only in dry surroundings. Any condensation that occurs must be allowed to evaporate before putting the generator into operation. Long periods of exposure to sunlight and excessive warming by external energy sources are to be avoided.

Do not continue to use the instrument should any mechanical damage occur. The instrument's housing and the cable have both an insulating and a screening function, which can only be assured while the housing is intact. Return a damaged generator to a EM Test service centre immediately for repair. EM Test, Switzerland and the associated sales organization accept no responsibility for personal or material damage nor for any consequential damage that results from irresponsible operation of this instrument.

### 3 INTRODUCTION

Under appropriate ambient conditions, both material objects and even the human body itself can become charged with electrical energy. This effect is due to "electrostatics", a phenomenon that has been known since the earliest times. Thales von Milet (600 BC) noticed how amber attracted very light particles when it was rubbed. Touching a charged item against a conductive object leads to a charge equalization through a spark discharge, which produces a brief but powerful electromagnetic field.

#### 3.1 Electrostatic discharge (ESD)

This effect can be explained as follows: Two insulating substances with differing dielectric constants become charged when rubbed together, i.e. one material gives electrons to the other one. This effect is known as electrostatic charging.

The same can happen to a person. When somebody walks around in a dry atmosphere on carpet while wearing shoes with good insulating properties, a charge of several thousand volts can be built up. If, now, that person comes close to a conductive surface, the charge that he or she is carrying flows away through a hefty spark discharge.

The high equalizing current that flows, and the associated large electromagnetic field that hence results, can cause electronic devices (computers, terminals, process controllers, vehicle electronics, solid state devices, credit or memory cards, etc.) to malfunction or even be destroyed.

#### 3.2 Simulation

A systematic investigation of electronic equipment and installations to determine their electromagnetic compatibility (EMC) is, today, a necessity if one is not prepared to suffer the economic disadvantages that could otherwise ensue. As a logical consequence, appropriate testing is now a legal requirement for the sale of electronic products within the EU.

The ESD test plays an important role in the range of interference sensitivity tests. It simulates frequently occurring effects and guides the development engineer to any weak spots in an instrument or item of equipment through a combination of high voltage and high frequency properties.

A simulation device must be constructed such that it reproduces practical conditions realistically. Furthermore, the results obtained (interference sensitivity threshold) must be reproducible.

The interference immunity of an instrument is not only depending on its construction, it is also largely dependent on the quality or the consistency of the mass production techniques used. Knowing this has led to the demand for individual testing or at least random sample testing.

Further weak spots, which could affect the overall interference immunity, can arise through the assembly of instruments into complete systems because of the installation method used, the cabling and the earthing. An ESD check on systems is therefore also prescribed. Such tests provide valuable information about the immunity of the system to effects that occur only sporadically under operating conditions and hence represent difficult to detect sources of disruption.

The ESD simulator esd NX30 fulfils the requirements of numerous applications in an ideal manner, thus:

Ergonomic shape:	For non-tiring use.
Operation:	Operating elements and display always in view of the user. Constant check on the test values.
Battery-powered: (esd NX30 only)	Independence from a mains power feed.
Carrying case: (esd NX30 only)	Generator and its accessories can be readily packed and conveniently transported.
Microprocessor-control:	All the functions are "on-board", including a pre-settable counter, pre-programmed test values, discharge voltage detection, etc.
Precision:	The test parameters are maintained precisely for reliably reproducible tests.
Flexibility:	The specifications prescribed in the standards are more than fulfilled in every respect. The instrument also offers many additional handy features.
Safety:	The high voltage generator is automatically deactivated if the instrument remains unused for a period of time.
Longterm operation:	Automatic longterm operation for stationary applications with the generator mounted on a tripod.
Application field:	Development optimization, type-approval, EMC certification, batch testing (individually), testing of fully installed systems.

### 3.3 Effects on the EUT

The most significant interference components of an electrostatic discharge are of a high frequency nature. The interference paths and effects have to be assessed in the range from about 30 MHz to multi-GHz.

The extremely rapid rise time of a discharge affects an object under test mostly through:

- Magnetic HF-coupling between electrical conductors in the electronics and the discharge current path.
- Electrical coupling between the discharge current and signal lines. A discharge current to the EUT flows proportionally through all the associated conductors (earth, mains, data lines, screening, etc.) according to their relative impedance.

Malfunctions in insufficiently immune electronic equipment and systems make themselves apparent through:

- Program crashes
- Blocking of command sequences
- Incorrect commands, statuses or data being further processed
- Partial system resets (e.g. only in peripheral modules, which lead to errors that the system does not recognize)
- Disturbance or destruction of interface modules
- Destruction of insufficiently protected MOS components.

ESD (electrostatic discharge) testing usually shows up all the weak spots in the HF-range of a piece of equipment simultaneously. The uses to which the esd NX30 ESD simulator can be put hence go way beyond those called for in standard-conform applications.

This instrument provides the engineer with a means to detect sources of error caused by unsuitable earthing, poor ground connections, insulation problems, etc.

The generator also serves as a reliable aid for localizing hidden wiring faults during acceptance trials on installations.

Use can also be made of the instrument as an insulation tester to determine the breakdown voltage of switches, relay contacts, insulators, etc.

## 4 THE esd NX30 SYSTEM

By using the latest materials, construction methods and manufacturing techniques for the robust housing shell, together with highly insulated modules, the newest high voltage technology, the touch-sensitive operating panel and a control unit built using the SMD technique, it has been possible to integrate all the functions that a comprehensive simulator system should offer into one compact instrument.

Professional industrial designers have ensured an optimized ergonomic concept. The instrument, with its well-balanced handgrip, sits comfortably in the user's hand and guarantees non-tiring operation. Both the operating elements and the display window remain in view of the user while work is in progress.

The esd NX30 offers optimal freedom of movement around the work-place and is an ideal test instrument not just for the development engineer but also for quality control purposes, system tests and for investigations in the field.

The esd NX30 features additionally a build in, switched, bleed off function. This function is particularly useful in applications where the EUT discharge point is not connected to ground (ex: battery powered equipment, connector pins , etc.). In such cases a build in bleed off function can avoid external manual bleed off to be done between 2 discharges.

As supplied in the basic set, the system is equipped with a 150 pF / 330 Ω discharge network for the IEC / EN 61000-4-2 and ISO 10605 standards.

The discharge voltage of up to 30 kV for both air-discharges and contact-discharges ensure a comfortable test margin over and above the levels called for in the standards.

The instrument is well equipped to cope with other (and future) standards. The accessories include various networks and discharge tips that can be attached by the user himself.

The basic set contains everything necessary for general use. A rich assortment of accessories for special tasks is available such as a remote triggering unit, further discharge networks, an ergonomically shaped carrying case, a tripod adapter, test tips, etc.

### 4.1 The simulator

The esd NX30 simulator is modularly constructed from a number of discrete function units and is available in two models:

#### Features and Accessories

	esd NX30	esd NX30.1
Air Discharge to 30kV	Yes	Yes
Contact Discharge to 30kV	Yes	Yes
Storage and transportation case	Yes	No
An internal battery tested to 30,000 pulses at 30kV	Yes	No
Optical interface for software control	Yes	No
Interlock	Yes	No
Remote Trigger and EUT Fail Input	Yes	No
Self Test	Yes	No
RCN 150-330	Yes	Yes
Internal Bleedoff (DUT Discharge) Function	Yes	Yes
Pistol Stand	Yes	No
25mm Discharge Sphere	Yes	No
Earth connection (rear)	Yes	No
Threshold Settings High and Low for Pulse Detection	Yes	No
R/C Module Detection	Yes	No
Saving User Test Programs	Yes	No

Also available are two AUTO sets designed with additional RCNs to fulfill the most common automotive requirements.



### 4.1.1 Function modules

The base station contains the battery supply, the high voltage generator and regulator as well as several safety features.

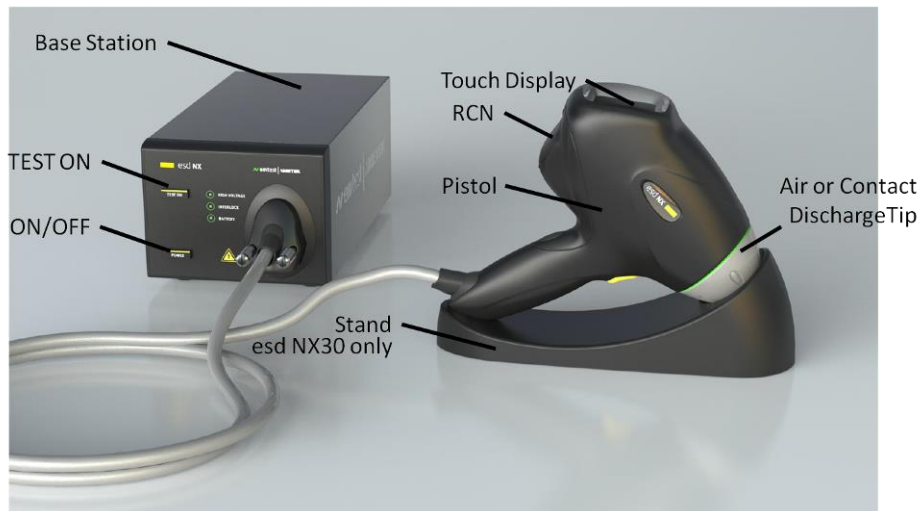

The pistol houses the interchangeable pulse network, high voltage relay, the exchangeable discharge tip, measuring electronics and the touch sensitive input / display panel.

### 4.1.2 Block diagram

The various function units are shown in the block diagram:

Block diagram of the base station:

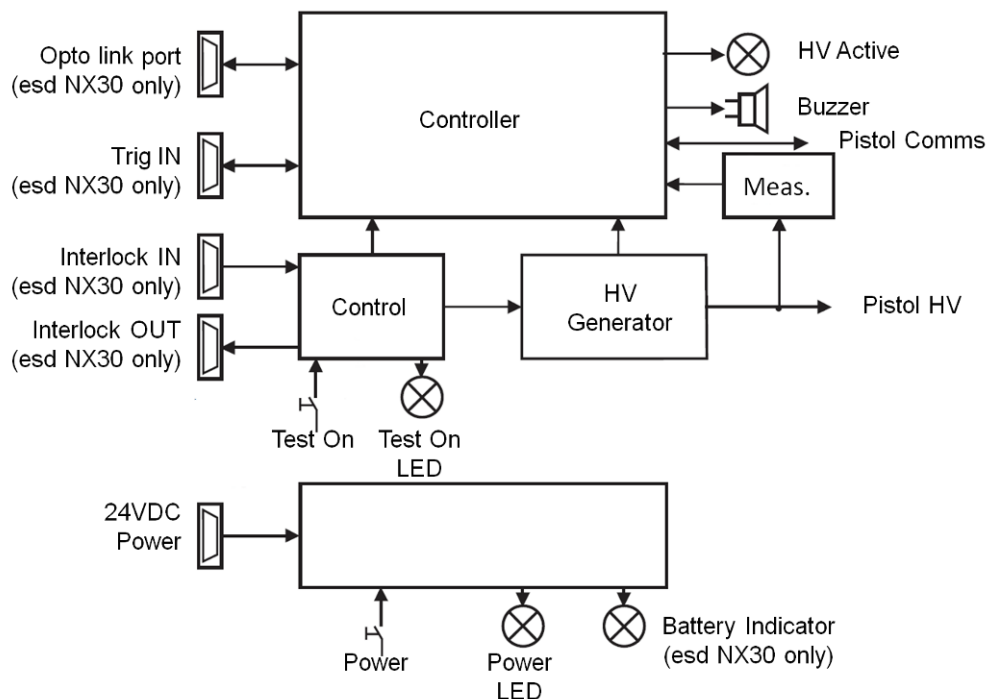

The microprocessor controls and monitors all the simulator functions:

- Touch-panel entries are checked for plausibility. Unacceptable entries are rejected and an acoustic warning notifies the user of the error.
- Values entered are clearly shown on the large display screen. Further information shows the operating status and the counter settings.
- The battery charge state is continuously monitored. The display warns if there is a tendency towards low voltage. The instrument's functions are inhibited once the battery voltage is insufficient to guarantee the pulse parameters.
- The actual tip is detected and the actual discharge mode will be shown.

- High voltage generation is dynamically controlled by the processor. Varying load conditions, supply voltages, etc. can thus be taken into account and have no effect on the pulse parameters.
- The instrument switches itself off automatically if it is not used for a while. The pulse parameters and operating mode remain stored and ready for re-use.
- The charge voltage to the network is kept constant as long as the trigger is active. The high voltage is discharged internally when the trigger is reset.
- If no discharge occurs when set for an air-discharge and the trigger is active, the processor waits for about 30 s then autonomously resets the trigger and discharges the network internally with simultaneous acoustic warning.
- Pulse triggering is monitored. Once an arc has occurred the network is discharged internally so that no further arcing is possible.

### 4.1.3 Operating elements

Apart from the trigger button itself (pulse triggering), all the operating elements, test-relevant setting and user information are presented on the touch-sensitive display panel facing the operator.

The esd NX30 is switched on and off with the main power switch. The significance of the elements in the display field can be seen in the following picture. Further information can be found in section "Operation".

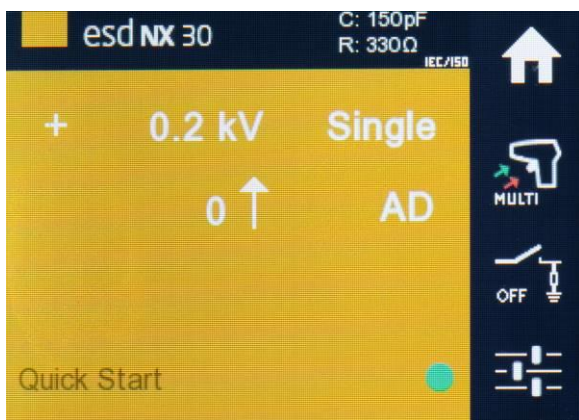

All operations are performed via the touch-panel.

This is an example of a display shown on the panel when the pistol is switched on.

The function of the trigger button on the handgrip depends on the operating mode currently selected:

- As a pulse button in single discharge mode (1 pulse each time it is pressed).
- As an on / off switch in repetitive mode (discharges while button is pressed).
- As a pausing on / off switch in repetitive mode with the preset counter in operation (starts the discharges by pressing the button and stops the discharges by pressing the button again).

The remote control facility replicates the action of the trigger button by means of appropriate control signals.

## 4.2 System components

The basic set is packaged in a practical carrying case and comprises:

- Carrying case (esd NX30 only)
- ESD simulator esd NX30 consisting of pistol and base station with battery power supply
- Discharge network 150 pF/330 Ω to IEC / EN 61000-4-2 and ISO 10605
- 1 each air and contact discharges tips
- Battery charger / mains power pack
- Pistol stand (esd NX30 only)
- Operating instructions

This set contains all the items necessary under normal conditions to conduct tests conforming to the IEC / EN 61000-4-2.

### 4.2.1 Battery charger / power supply unit

Power to the instrument is provided through a universal mains unit suitable for input voltages between 80 and 240 VAC. This same unit also serves as a charger for the integral battery pack.

Charging of the battery takes about three hours. At this point a timer switches the charger to a reduced charging current and the indicator lamp changes from red to green.

The battery will also charge up when the instrument is switched off. A full battery charge will suffice for several days of normal test operation.

Battery life expectancy (esd NX30 only):

- The esd NX30 is designed to provide 30,000 discharges at the full 30 kV over many hours
- Ambient temperatures over 50°C can lead to degradation of the battery. If treated carefully, more than 300 charge / discharge cycles can be expected without a noticeable reduction in capacity.
- The charger and battery-pack form a matched entity. The battery must not be charged from any other unit and the charger is to be used exclusively for the intended purpose.

Operating advice:

- Use the equipment only in dry surroundings.
- Recharge the battery about every 6 months even if the instrument is not being used.

### 4.2.2 Options

A range of additional accessories is available for special applications and for testing to alternative standards:

- Discharge networks and test tips for other standards
- Fast rise time tip
- Coaxial measurement target
- Tripod adapter
- Opto link to a PC
- H-field adapter
- Flexible test tips
- External discharge remover
- Etc.

### 4.2.3 R/C Discharge Networks

The basic set contains a discharge network and tips for conducting tests that conform to IEC / EN 61000-4-2 (2008). Alternative networks can be installed for testing in accordance with other standards.

Several networks are given in the order list. The C and R values of the discharge network can also be specified for other applications. Networks conforming to other standards can be built upon request. The only calibration method that is supported is those according to IEC 61000-4-2.

Exchanging the discharge network is described in section "Exchanging the R/C network".

#### 4.2.4 Remote triggering (esd NX30 only)

This port is indented to allow the user to connect external signals in order to remote control the esd NX30 generator, as well as to connect external accessories like the charge removing device. See tables and graphs below for detailed signal description and drive circuitry information.

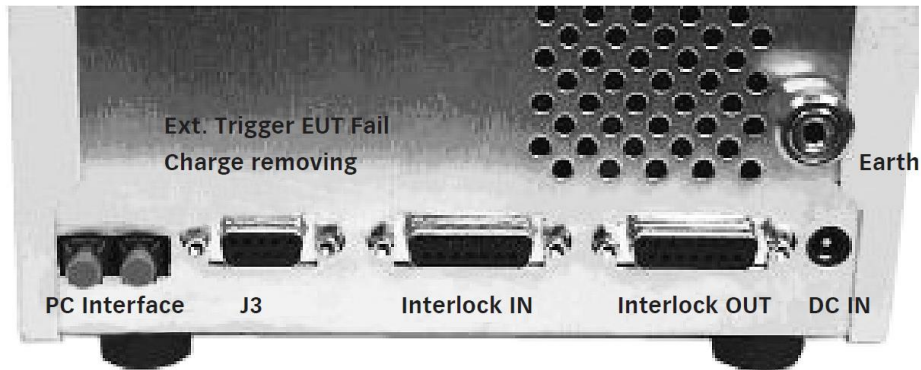

**WARNING**

Care has to be taken that the cable used to connect to this port is made with good shielding concept.

The shield itself needs to be linked with the housing such as to prevent any ESD hazard to the controller board.

Connector J3: Pin Assignment

Pin	Signal Name	Description
1	EXT_TRIGGER	External trigger input
2	NC	-
3	NC	-
4	EUT_FAIL	EUT failure input (reserved for future use)
5	GND	Earth
6	NC	-
7	Charge remove	Charge remover drive output
8	GND	Earth
9	+15V	Voltage output (max 500 mA)

##### Ext. Trigger (esd NX30 only):

The following circuit is built in behind the external trigger input connector. This function is similar to the function of the yellow trigger knob on the handle. Trigger signal active low, i.e. to be pulled to ground.

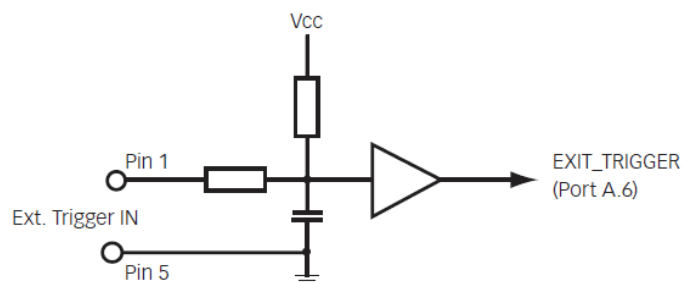

##### Charge removing connection (esd NX30 only):

This function is to drive an external bleedoff switch option or an external relay.

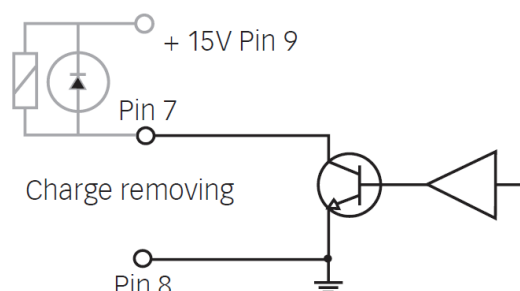

#### 4.2.5 Interlock (esd NX30 only)

The esd NX30 has an integrated interlock system in accordance with standard practice for high voltage test equipment.

This system has the following functions:

##### Inputs

1. Input for external monitoring purposes of, for example, special coupling networks and access control.
2. Internal emergency off button opens the interlock.

##### Outputs

1. Operating mode: the esd NX30 can generate no high voltage as long as the interlock is not closed. High voltage generation is prevented if the interlock is opened during a test procedure.
2. Interlock output for other system devices.

The instrument is equipped with two 15-way connectors for interlock input and output. The interlock loop must always be correctly terminated at both ends. In achieving this, the interlock wiring must connect all the safety contacts together.

An arbitrary number of instruments or accessories can be incorporated in this safety concept.

The high voltage supply can only be activated if the safety requirements in all the associated devices are fulfilled (emergency off buttons released, safety contacts closed).

The control of the warning lamps must make use of the interlock feature. The instruments can be switched on and the red lamp lights up as soon as the interlock circuit is closed.

The pair of terminating connectors supplied must be utilized in the case of not making use of external interlock contacts.

Signal specifications:	Voltage 48VDC max. Current 20mA min., 1A max
Connector	Socket, D-sub, 15 pin.
Max. permissible cable length:	Correct operation guaranteed up to 10m (screened cable)

Operation should be insured via potential-free switch contacts.

All signals are active low, i.e. switched to GND.

The pin-out of the interlock input and output connector is identical. All the pins are connected together. The connection to pin 3 is made internally through the emergency off button. This link is broken when the internal interlock is activated.

Pin number	Function
1	Earth (GND), 0V
2	NC, linked through the other connector socket
3	Interlock input / output (connected inside the instrument)
4	NC, linked through the other connector socket
5	Interlock status (triggers the interlock function in the instrument by relay from +12 to +48 V)
6	NC, linked through the other connector socket
7	NC, linked through the other connector socket
8	NC, linked through the other connector socket
9	Switches warning lamps and peripherals on (active, provided that esd NX30 is switched from standby to on).
10	NC, linked through the other connector socket
11	NC, linked through the other connector socket
12	NC, linked through the other connector socket
13	NC, linked through the other connector socket
14	NC, linked through the other connector socket
15	NC, linked through the other connector socket
Shell	Shielding

Wiring diagram for the interlock system:

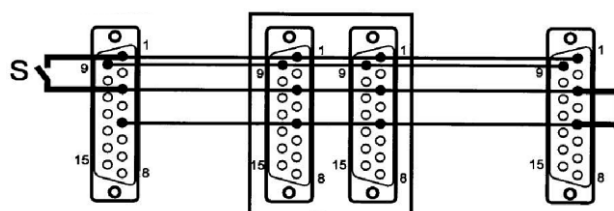

**S:** External safety switch (e.g. test enclosure hood, door contact, panic button, etc...)

Several interlock inputs of this type may be connected in series.

The contacts should be connected in series if numerous access barriers are necessary. Either one open contact or a voltage of more than 1.5 V at the input is sufficient to disable the simulator.

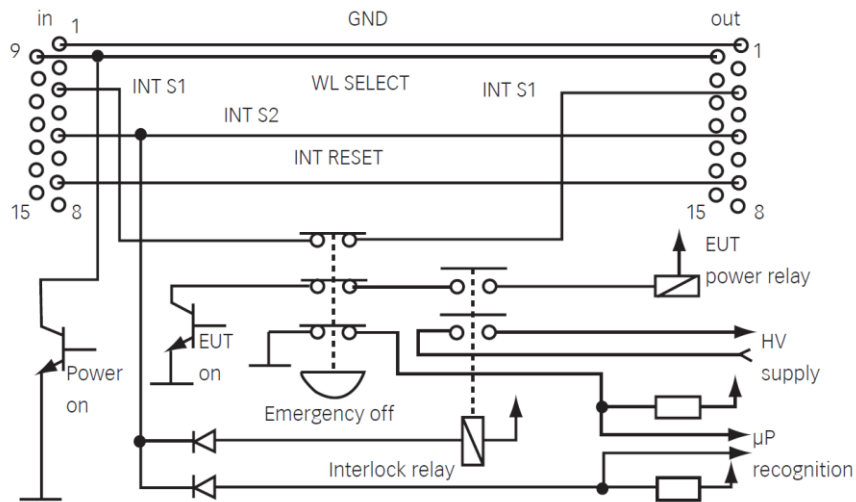

## 5 COMMISSIONING

Immediately upon receipt, check the instrument and the accessories for completeness and look for any transport damage. Damage incurred in transit must be reported to the transportation undertaking without delay.

Before putting the instrument into operation:

- Study the manual
- Take the necessary safety precautions
- Charge the battery, if equipped (see section "Battery charger")
- Plug the interlock terminators into the base station, if equipped
- Connect the earth cable correctly  
(the esd NX30 must never be switched on without a solid earth connection being made).
- Allow the instrument to dry out if any condensation has occurred

### 5.1 Function test

Switch the simulator on with the POWER switch.

The instrument performs audible switching operations for a few moments as it runs through a self-test and calibration procedure. The instrument is ready for use once the self-test routines have been completed.

The display comes up with last used settings, and will look like this:

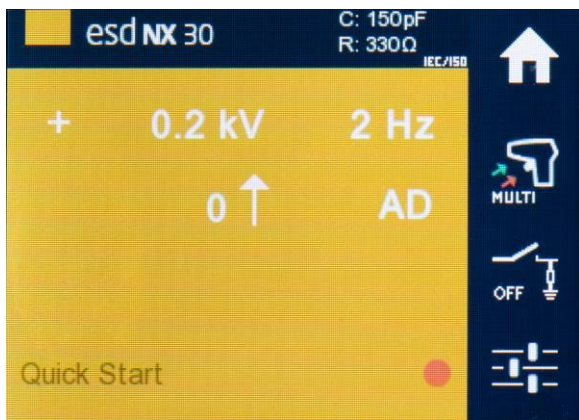

The “ready indicator” will be shown in red until the TEST ON button is pressed.

High voltage generation is activated by pushing the trigger button and keeping it pressed. By bringing the discharge tip close to the earthing point an arc discharge occurs which is acknowledged acoustically.

## 6 OPERATION

This section of the manual provides a guide through the numerous operating possibilities of the esd NX30.

The operation, hierarchically arranged, is therefore easy to remember. The display shows unmistakable information about the parameters that have been set and the operating status of the simulator.

For safety reason, the instrument refuses to accept any invalid entries.

It is recommended to carry out the examples directly on the instrument (not forgetting to connect the earth cable!).

### 6.1 Switching on

Ensure the interlock terminators are plugged into the rear of the base station, if equipped, or otherwise the interlock loop is complete.

Plug the pistol HV connector into the base station and tighten the screws.



**ATTENTION**

Ascertain that the earth cable for the pulse return path is solidly connected to the fixed installation's earth point.

There is a danger of electric shock if this is neglected!

Press the **POWER** button

Press the **TEST ON** button. The **INTERLOCK** LED will extinguish and the red **HIGH VOLTAGE** LED blinks while the pistol runs its self-test and calibration routine.

The instrument is ready for use immediately after self-test and calibration procedures have been completed. High voltage generation is activated by pressing and holding the trigger button. The active high voltage state is indicated on the base station by a blinking LED.

Should a parameter need changing the operator has only to press on the relevant field in order to call up the appropriate menu.

Successful air discharges are detected. A differentiation is made between this and the set value by the display "kV" flashing green. If no valid discharge occurred, the display shows a "0" value and the kV symbol will flash red. The Threshold function (see section "Threshold") permits various settings for the sensitivity of the breakdown voltage detector.

The effective discharge voltage depends on various factors such as the distance to the discharge point, speed of approach, nature of the EUT, etc.

In the case of a contact discharge this measurement is not carried out since only a discharge current can occur.

The instrument switches itself off automatically after 15 minutes of non-use.

### 6.2 Battery monitoring (esd NX30 only)

The battery charge state is monitored continuously. An insufficiently charged or an empty battery is shown on the display.

 Recharge the battery soon when this symbol is displayed. Correct operation and valid pulse parameters are still assured.

 The battery is more or less empty; its capacity is insufficient to maintain all the instrument's functions. An appropriate warning message is shown on the screen and all the instrument's functions are inhibited.

A full battery will provide sufficient power for several days of normal test usage. The actual operating time depends, of course, to a large extent on the conditions prevailing at the time.

The following figures have been obtained by way of reference:

- Battery freshly charged
- Contact-discharge with 30 kV
- More than 30'000 discharges can be generated

### 6.3 Operation and settings

The operation of the instrument and all settings are carried out by way of the touch-panel starting from the menu "TEST". Generally, the following applies:

- Frames symbolize push buttons. Touching these sensitive areas causes a reaction, usually branching into another menu.
- Values and indications that are not in frames are for information only. Pressing the trigger button always takes you up one menu level higher.
- A virtual keypad appears in parameter setting menus.
- R / C value shown on main screen for convenient direct reading.



### 6.3.1 Display mode

When adjusting some parameters, a keyboard and up / down buttons can be selected.

Numerical values (voltage, preset counter, random repetition times) can be entered just the same as with a pocket calculator.

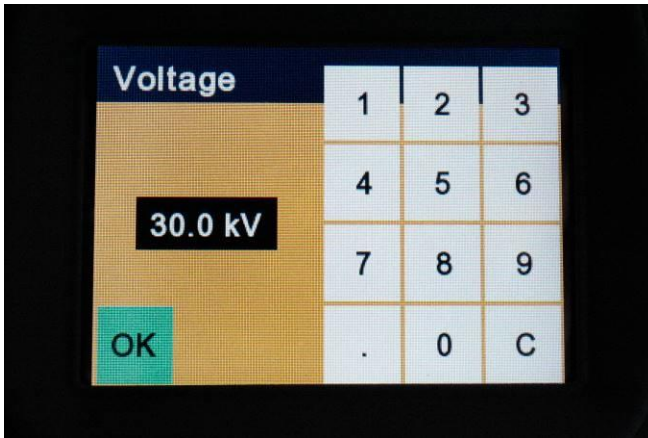

Selection functions (such as language, type of discharge, program number, etc.) are handled by up / down buttons to scroll through the settings.

### 6.3.2 Voltage

Touching the voltage indication brings you to the submenu for adjusting the discharge voltage. Set the required value and press "Ok".

### 6.3.3 Polarity

The polarity indication brings you into the relevant submenu. Choose between + or – . If the pre-select counter function is active there is the further option of choosing alternating + / - polarity.



Around the max. voltage range some minor delay for triggering shall have to be expected (fully discharging-changing-recharging).

### 6.3.4 Counter

Use the counter button to branch into the corresponding menu. Choose the counter mode: Preset counter on / off. In the On state the counter content can be set. When the simulator is in operation the preset counter counts down until it reaches 0, which then terminates the selected test sequence.

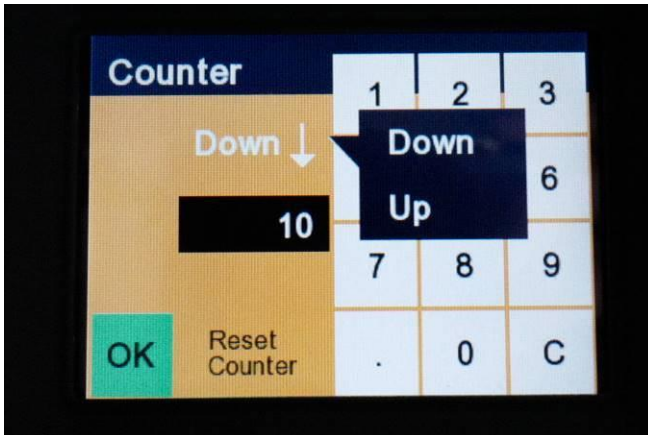

Reset counter sets the counter content to 0 or it reloads the preset counter with the previously selected value.

#### Pulse release behavior

Four modes of triggering are supported:

- Press to Start, Press to Stop
- Press to Start, Release to Stop
- Single (on Press)
- Single (on Release)

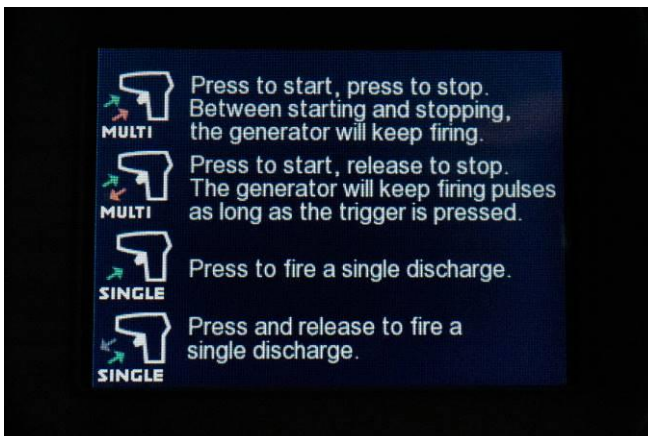

### 6.3.5 Repetition

The repetition button takes you into the menu to select either single pulses or a repetition rate from 0.5 to 25 Hz in air discharge, or from 0.5 to 20 Hz in contact discharge mode.

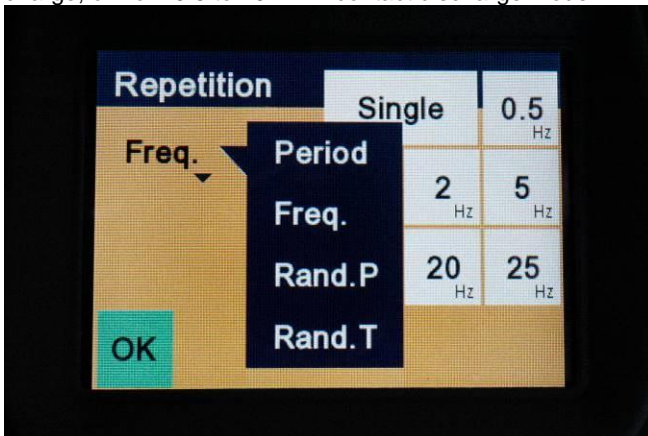

Four further repetition modes are available that trigger pulses with a statistical distribution over a specified period:

Random P: 1 – 9999 pulses are triggered with a statistically distributed repetition rate ranging from a minimum of > 20 ms to a maximum repetition rate of < 2000 ms.

Random T: Pulses are triggered during a period of 1 – 9999 seconds with a statistically distributed repetition rate ranging from a minimum of > 20 ms to a maximum repetition rate of < 2000 ms.

Free Adjust: For some specific requirements like R&D jobs or product standards, the prestored repetition times provided in Hz may not match all needs. Allows entering values between 0.04 up to 300.00 s in 0.01 s steps.

### 6.3.6 Discharge Network

Depending on mounted tip the sign shows the actual discharge-mode AD (air discharge) or CD (contact discharge) The R/C values for the relevant network are also shown. The corresponding value is automatically loaded.

Air-discharge = round test tip

Contact-discharge = sharp point test tip

### 6.3.7 DUT Discharge Mode

DUT Disch.		1	2	3
Ts	1.0 s	4	5	6
Td	1.0 s	7	8	9
Tr	1. s	.	0	C
ON	OFF			

The DUT discharge mode sets if an internal or external discharge should be used. For most users, Internal is correct. A simple tap of the various timings will select the value, enabling the user to input the time with the numeric keypad.

- Ts “shoot”. This is the minimum time that is used to shoot a pulse.  
In contact discharge mode, this is quite precise, however in air discharge mode, the gun will wait up to a maximum of 30s to allow the user to approach, and make contact to the DUT.  
As soon as a valid discharge is detected, the discharge relay will go open circuit.
- Td “discharge” – the time used to discharge the DUT. During this time, the DUT will be discharged.  
If internal mode is chosen in settings, the tip must remain in contact to the DUT to discharge any remaining energy stored in the DUT.
- Tr “repetition”  
The waiting time before the next discharge. The discharge relay is open circuit during this time.
- ON/OFF sets the DUT discharge function to on or off. This will take you immediately back to the home screen.

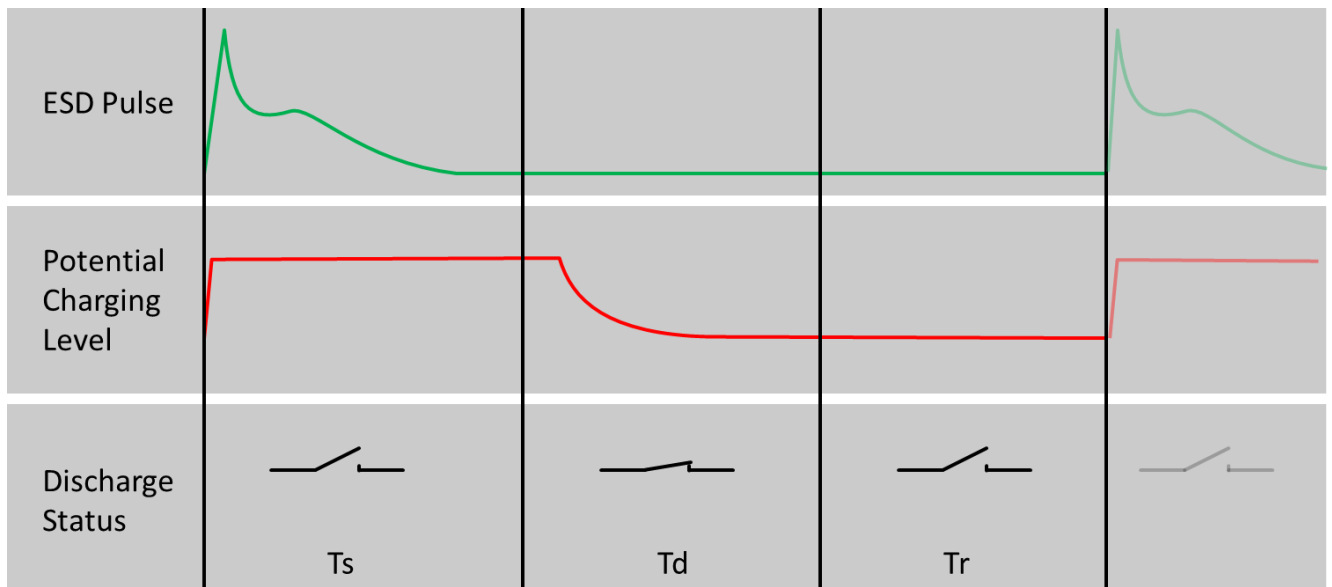

**EUT discharge on esd NX30/NX30.1:** To remove the charged energy of a EUT, the simulator has an switch. With the time of the charge removing procedure can be programmed. All timing parameters can be set from 0.1 up to 99 s in 0.1 s steps. The DUT will be discharged during T2.

**External EUT discharge on esd NX30:** To remove the charged energy of a EUT, an external charge removing box can be connected to the base station.

### 6.3.8 Settings

This further branches into a range of submenus, thus:

### 6.3.9 Program

Shows all the details of the currently selected settings in the "Actual" state. These values can be saved in one of the eight memory places by pressing **store**. Alternatively, a previously saved set of values can be recalled using the wheel in the **actual** program. Touching OK loads the selection ready for execution.

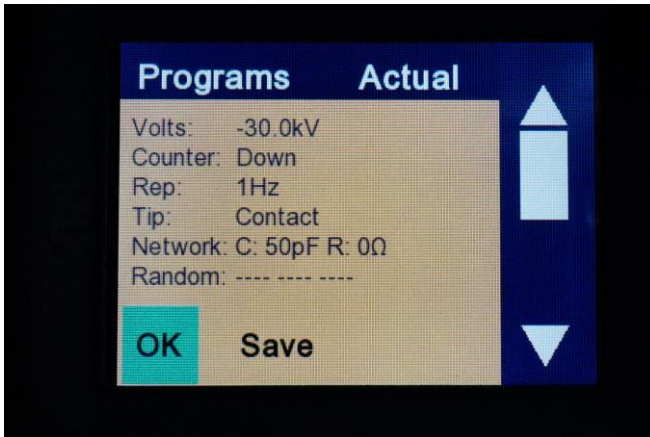

### 6.3.10 Activity Log

An activity log is provided, allowing the user to scroll through the tests shown in hours and minutes before the present. Changing the relevant test parameters will cause a new entry into the log to be created.



The Log is in volatile RAM and will be saved each time the gun is switched off or goes to sleep.

Please switch off the gun properly, simply cutting the power to the esd NX30 can result in loss of data.

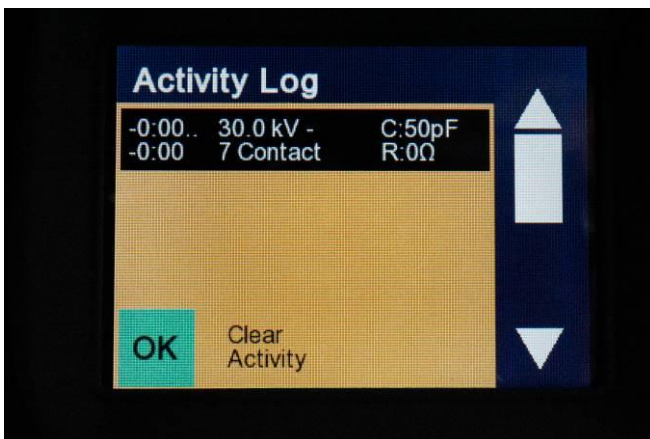

### 6.3.11 Language

Touch the button and choose the language you wish to use with the wheel.

### 6.3.12 Device info

Gives information separately for the pistol and the base, including:

- Firmware version of the base station and pistol
- Life of the generator
  - The number of times the contact discharge switch (in the pistol) was activated
  - The total operating hours (uptime)
- Calibration information
  - Date of the last calibration
  - The calibration certificate number

Device Info	
<b>Pistol</b>	
Software Version:	V06.99
Switch Counter:	5429
<b>Base Station</b>	
Software Version:	V06.99
Operating Time:	168h 0min
<b>Calibration Info</b>	
Last Cal:	8/29/2019
No.:	none

**NOTE**

Only users of esd.control can set the Last Cal and certificate number. For best results, be sure to use an authorized AMETEK CTS calibration laboratory.

### 6.3.13 Threshold

This function permits different sensitivity levels to be set for the arcing detector whereby a differentiation can be made between stray discharges and a true discharge onto the EUT.

#### Normal

Arcing is detected and is indicated by the kV symbol on the display blinking provided 20% (or more) of the charge voltage is dissipated.

#### Low

Arcing is detected and is indicated by the kV symbol on the display blinking provided 10% (or more) of the charge voltage is dissipated.

#### High

Arcing is detected and is indicated by the kV symbol on the display blinking provided 30% (or more) of the charge voltage is dissipated.

#### Off

This position is made for EUTs with non-conductive surfaces ( housings) and counts every contact discharge, and every time the air discharge is stopped with the trigger.

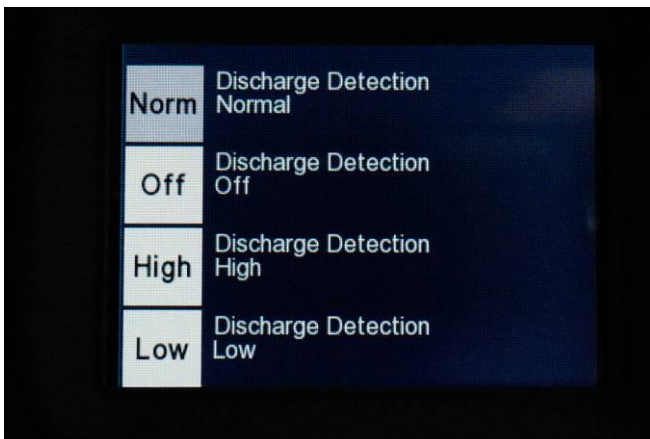

### 6.3.14 Display Settings

The Display Settings menu allows users to set the brightness and to determine how long before the simulator sleeps in battery mode (esd NX30 only).

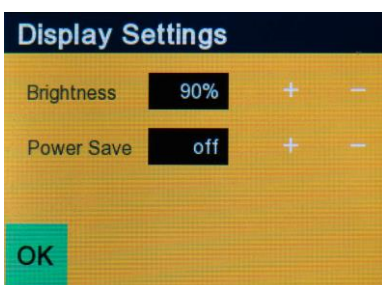

### 6.3.15 ISO-Selftest

Provides the means to select the required, pre-programmed standard test (e.g. IEC / EN 61000-4-2, level 4).

Just starting the ISO-Selftest gives a quick response of the proper operation of the ESD simulator. The screen reflects all required voltage levels as well as the tolerances in table form, based on the ISO 10605 standard.

During the calibration procedure the HV module is strained up to 30 kV in steps, and the charge voltage is measured, checked if in tolerances and validated for each step.

If somehow the maximum voltage could not be reached or hold, the esd NX30 comes out with an error message Nr. 210 cal. Failed. The calibration procedure is diagnosing, to which voltage level the instrument works properly. This voltage value will be shown on screen. The instrument can be used for tests up to this voltage value, but it is recommended to return it to a EM Test/AMETEK service center for repair.

### 6.3.16 Continuous operation

Continuous operation can be established to produce a repetitive stream of discharges.

Pushing the trigger button starts the continuous operation; pressing it again stops the operation.



**WARNING**

Continuous operation should only be utilized in cases of real necessity since every ESD radiates electromagnetic disturbance the effect of which on the environment must be taken into consideration. The test area should be made out of bounds for unauthorized personnel. The test must be monitored throughout its duration. When running on battery the duration of the test is naturally limited.

## 6.4 The Home Screen

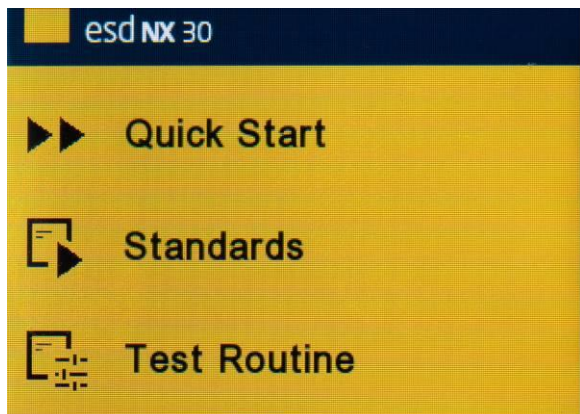

The home screen allows three methods of operation:

- Quick Start – Basic operation whereby users may set the voltage, choose test levels, air or contact discharge and timings.
- Standards – Where the standards are found for users who would like to go straight to the standard testing with limited ability to adjust settings.
- Test Routing – Select a previously stored test routine that has been sent from esd.control

### 6.4.1 Quick Start

This is fastest way to get started and all modes, voltage, discharge networks etc. can be used immediately.

The

### 6.4.2 Standards

Standards are pre-programmed for most IEC and ISO testing. The levels are pre-programmed for air and contact discharge and, in the case of automotive, the R/C network and the category as well.



In Standards mode, when the test level is selected, the type of tip (air or contact discharge) is taken into account, as well as verifying that the proper R/C network is used.

### 6.4.3 Test Levels

In addition to all basic settings found in this guide, users can also set various test levels for use during Quick Start mode, or may turn them off completely.

To set the test levels, choose Test Level 1 through 4 (TL1..TL4) and enter the voltage for both contact discharge (CD) and air discharge (AD) and tap "ON" and confirm with "OK". Conversely, if you do not wish to use test levels, set this to "OFF".



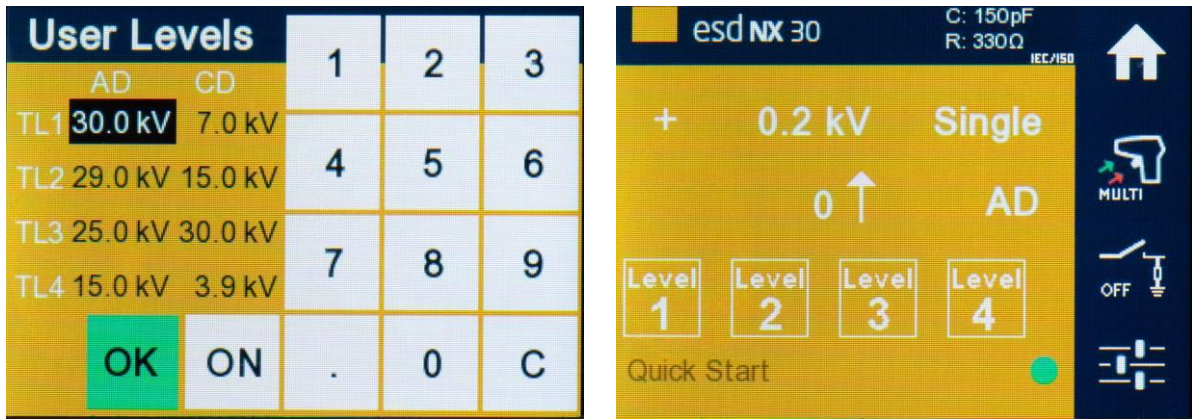



After setting the test levels, from the Quick Start screen, the test levels can be selected by tapping the corresponding “Level” number.

### 6.4.4 Test Routines

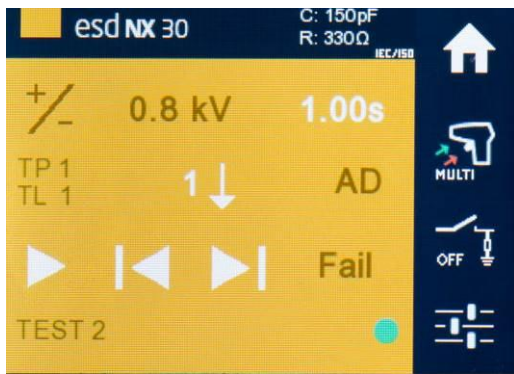
Test routines are used exclusively in conjunction with esd.control.



This mode adds some addition buttons not found in other modes:

- 

Starts and stops a Test Routine created in esd.control  
Pressing stop during the test run brings the user to the dialog to store the test (for reporting in esd.control) after confirmation.
- 

Before the test run: decrements the number of test points in the routine.  
During the test run, returns to the beginning of the previous test step.
- 

Before the test run: increments the number of test points in the routine.  
During the test run, skips to the beginning of the next test step.
- 

Stops the test and sets the “Fail” flag for the report.

Where you are in the Test Routine is shown by convenient information before and during the test.

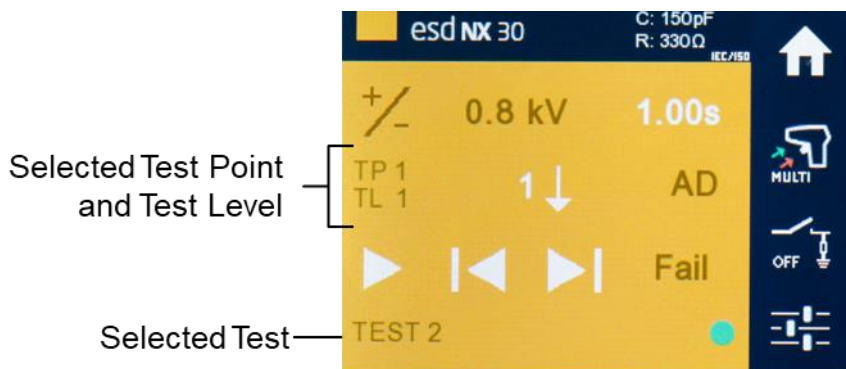

## 7 TEST PROCEDURES

Test standards, such as IEC / EN 61000-4-2, give detailed information about the assembly of the test rig, the associated organization, the EUT itself and the documentation.

### 7.1 Standard-compliant procedures

The ESD simulator system type esd NX30 is constructed in accordance with the requirements called for in the standard and is calibrated in a standard-conform manner.

The test engineer is duty-bound to study the relevant test requirements and adapt the facilities to suit the EUT in question.

The necessary documents can be obtained directly from the offices of CENELEC ([www.cenelec.org](http://www.cenelec.org)), the IEC ([www.iec.ch](http://www.iec.ch)), the ANSI ([www.ansi.org](http://www.ansi.org)), the IEEE ([www.ieee.org](http://www.ieee.org)) etc., or they are available from national standards bureau.

### 7.2 Other situations

It is not always possible to arrange a test rig in exact conformity with the relevant standards. However, by abiding by some basic rules, it is still possible to obtain meaningful assessments of a EUT's sensitivity to interference and to obtain valuable pointers to improving its immunity.

An electrostatic discharge is always associated with high frequency properties, which extend well above the 1 GHz range. Screening, earthing and filtering measures must therefore also be effective up into this range of frequencies.

The possible paths the pulse energy might take need to be thought about. It is absolutely essential the pulse return path is fed back through the generator's earth cable.

Due to better reproducibility the contact-discharge method is to be preferred over the air-discharge method. The former must, however, be arranged so that true metal-to-metal contact with the EUT is achieved.

Fast repetitive discharges are only of real use to quickly localize weak spots in construction or to pin-point critical situations in program routines. Single pulses are then to be used for detailed investigations and to assess the sensitivity to interference.

An exact record is to be kept describing the test conditions complete with photos of the test rig, details of the type and quantity of discharges, notes about the ambient climatic conditions, remarks concerning the effects observed etc.

Example of test set-up for automotive EUTs including harnesses and,

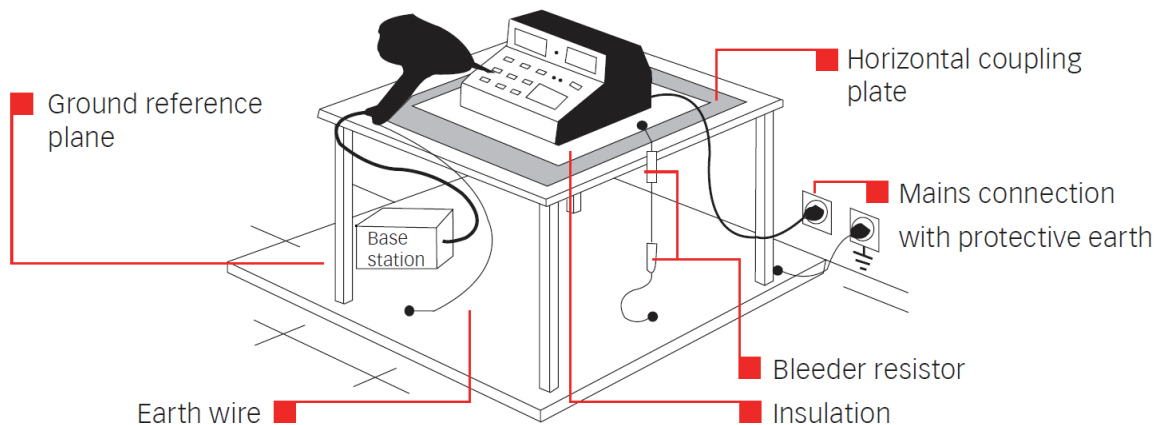

Example of test set-up for floor-standing equipment - laboratory tests and,

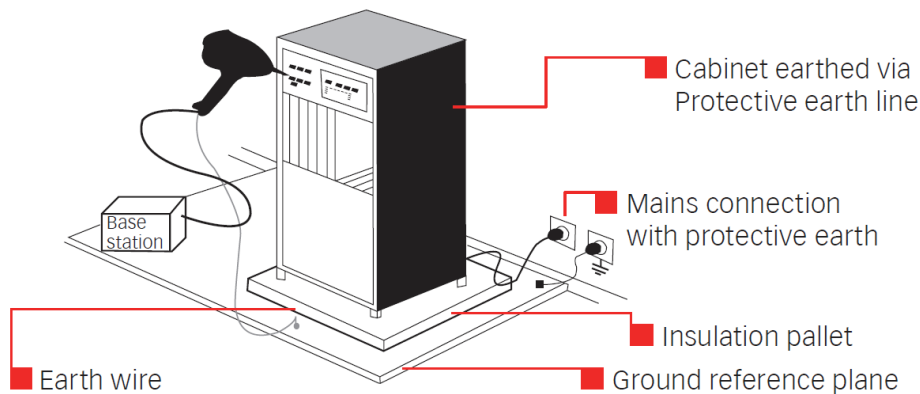



### 8 TYPICAL PULSE DATA

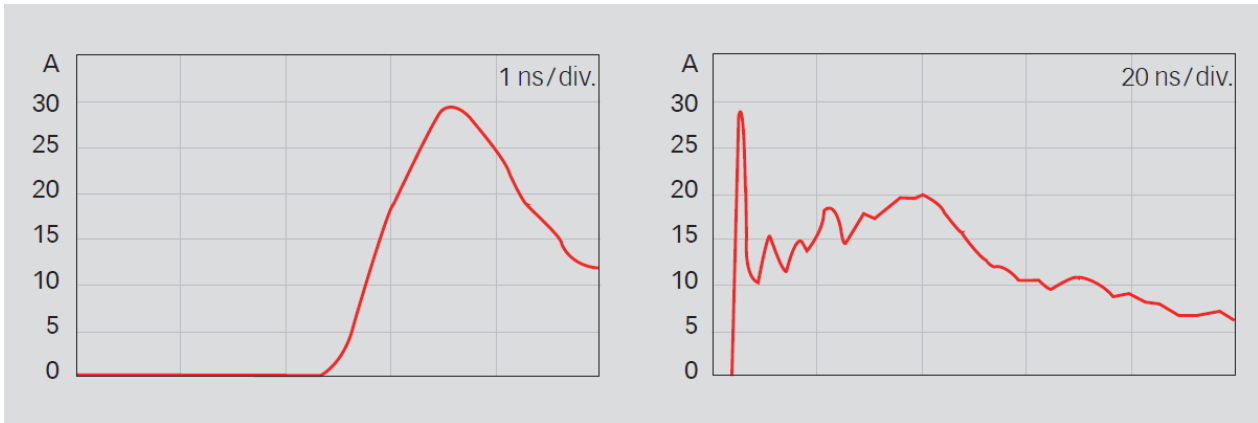

Contact-discharge 8 kV  
pulse rising edge (tr ca. 0.8 ns)

Contact-discharge 8 kV  
current at 30 ns und 60 ns

Reference figure quoted in IEC / EN 61000-4-2

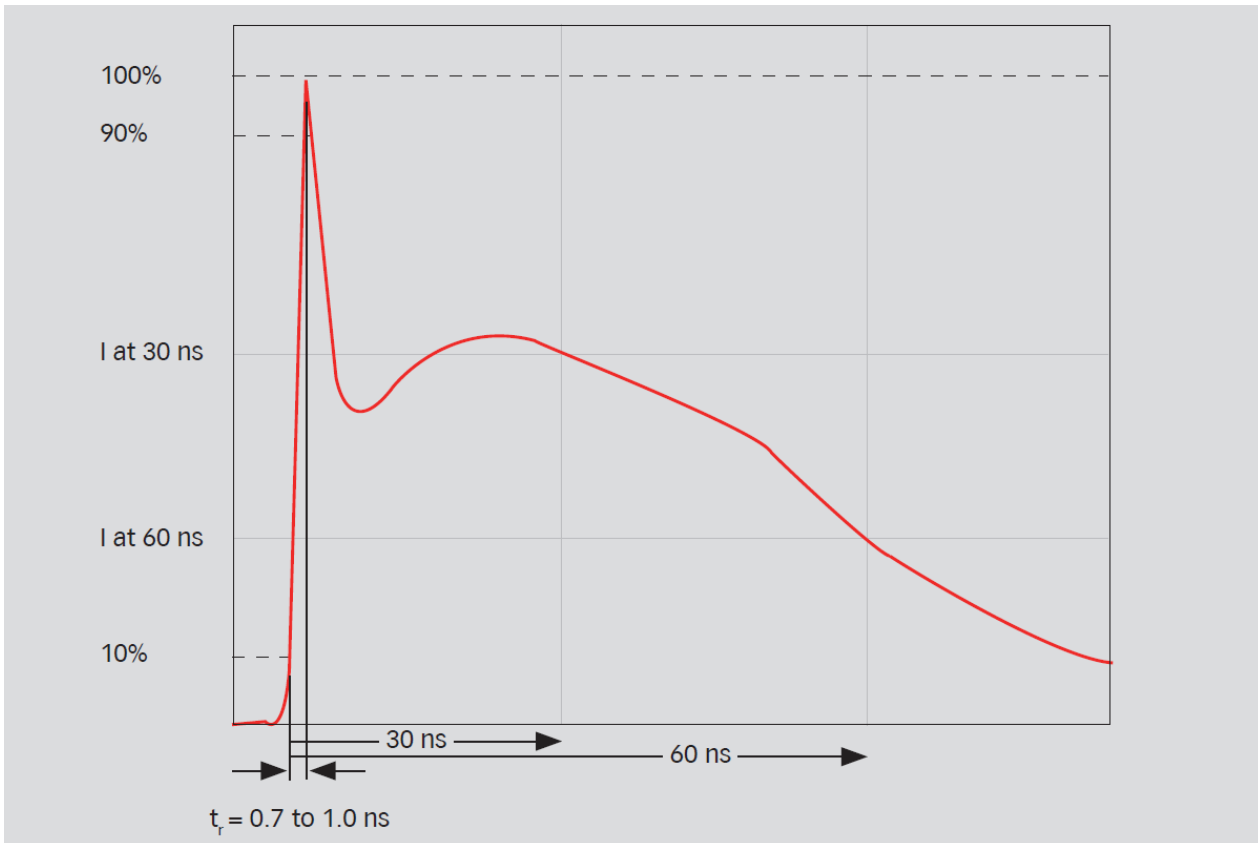

## 9 MAINTENANCE

### Cleaning

The housing can be cleaned with a moist cloth with possibly just a trace of detergent liquid. Industrial spirit is also a suitable cleaning agent. Other solvents are not permitted.

### Fuses

The instrument contains no fuses that are accessible to the user.

### 9.1 Calibration

Trimming procedures in the esd NX30 are carried out digitally and automatically. The instrument contains no elements that are foreseen for adjustment by the user. A component defect must be suspected if the calibration measurements differ from the published technical data and the instrument is to be returned to an authorized EM Test/AMETEK service centre.

Measurements can only be undertaken by trained specialists. A prerequisite is the availability of the necessary measurement equipment as listed in section "Verification of pulse data". Charge voltage check:

Equipment: EHT voltmeter with 40 kV voltage range

Internal resistance > 20 GΩ

Measurement accuracy < 1% Check the voltage level under the following conditions:

Air-discharge

Single-discharge

Polarity: positive and negative

Voltage settings: 2, 4, 8, 15 and 30 kV

Permissible tolerance < ± 5% of set value

Check the discharge current and pulse form as follows: Contact-discharge

Single-discharge

Polarity: positive and negative

Voltage settings: 2, 4, 8, 15 and 30 kV

Compare the measured values with the reference data in IEC / EN 61000-4-2.

These values are valid only for the discharge network that conforms to IEC / EN 61000-4-2. **Remark**

EM Test offers an accredited service for this kind of work!

### 9.2 Exchanging the R/C network



**WARNING**

If a network needs to be exchanged, the test has to be stopped first, followed by a waiting time of at least 5 s to ensure the voltage being internally discharged.

Switch the simulator off.

Open the flap under the display and rotate the pistol backwards until the network drops out under its own weight. Take care! Catch the network in the other hand.

#### 9.2.1 Reduction of the pulse repetition rate through higher capacitance

The maximum achievable pulse repetition rate will automatically derate as a result of using special discharge networks having a higher capacity. No other limiting effects occur, however.

### 9.3 Repairs

Repair work is to be carried out exclusively by an authorized EM Test repair department.



**WARNING**

Voltages in excess of 30 kV are generated within the instrument: **LETHAL DANGER!**

Only original replacement parts and accessories are to be used.

Do not continue to use the instrument in the event of mechanical damage occurring. The plastic housing also performs insulating and protective functions, which are only assured as long as it is in its original condition. A damaged instrument should be returned without delay to a EM Test service centre.

## 9.4 esd NX30 system error messages

Nr.	Text	Explanation	Action
006	INTERLOCK OPEN	The "Interlock-circuit" is open.	Press "Interlock Reset" button, or close the interlock circuit at the back of the base unit.
115	EUT FAILURE	The connected EUT has signaled a fault.	EUT input has been activated. Reset EUT first and then press return on screen.
125	HV SUPPLY TIMEOUT	The HV capacitor in the pulse network cannot be loaded in the specified time.	HV voltage module has detected some losses. Switch off the base station wait for 10 s, switch on again.
126	HV HOLD TIMEOUT	Unit stops after 30 s without discharge.	Press return on screen. Restart the test.
127	HV FAULT	An internal fault on the processor board has been detected.	Switch off the base station wait for 10 s, switch on again and continue testing. If error persists, contact your nearest EM Test service centre.
129	A FIELD IS SELECTED	The "Run" or the "HV-on" key has been pressed although an operator field is still selected.	Finish the input in the operator field and then start with "Run".
201	HV INTERNAL DISCHARGE	During test, an internal discharge has been detected.	Press return on screen and trigger again. If error persists, contact your nearest EM Test service centre.
202	BATTERY EMPTY	The battery is low and needs to be charged.	Recharge battery with the original power supply.
210	CALIBRATION FAILED	HV module can not reach the max. voltage during calibration procedure.	The voltage can be selected to the displayed maximum value. Contact you nearest EM Test service centre.
211	FAULT DETECTED	The software has found erroneous behaviour during generation of the pulse.	Stop the test. Switch off the base station wait for 10 s, switch on again and continue testing. If error persists, contact your nearest EM Test service centre.
217	VOLTAGE TOO HIGH	The selected value is too high.	Reduce the voltage level.
247	HV TRAF0 TOO HOT	NTC resistor too hot after endurance runs.	Power off the esd NX30 and wait about 1 h.

## 9.5 Disposal

The following list shows the principal materials used in the construction of the esd NX30. The relevant national regulations are to be observed when disposing of the instrument.

### Component material listing

Pistol housing:	ABS
Base station front panel:	ABS
Base station housing	Galvanized steel, lacquered
Circuit boards:	Epoxi with SMD components
LCD display and touch-panel:	Glass
HV module:	Polyurethane potting compound with electronic network components and copper wire
HV relay:	Div. metals, ceramic, div. insulating materials
Discharge tip:	Brass, plastics
Battery (esd NX30 only)	Nickel-metal hydride
Power supply:	ABS housing with transformer and circuit board with electr. components
Carrying (esd NX30 only)	case: Aluminum and polyethylene
Pistol	stand: ABS

---

(esd NX30 only)	
-----------------	--

## 10 TECHNICAL SPECIFICATIONS

Description:	Compact ESD simulator with microprocessor controller, large-surface touch-sensitive LC-display, built-in HV-relay for contact-discharges, built-in bleed off
Pulse data:	Conforms to IEC / EN 61000-4-2 and ISO 10605, with exchangeable networks for other standards
Pulse network standard:	150 pF / 330 $\Omega$ as per IEC, exchangeable networks for other standards as accessories Range R = 0 $\Omega$ ... 20 k $\Omega$ Range C = 50 ... 2000 pF
Air-discharge voltage:	200 V ... 30 kV (in 100 V steps) Tolerance < $\pm$ 5% (typical 2%, 1 ... 30 kV)
Contact-discharge voltage:	200 V ... 30 kV (in 100 V steps) Tolerance < $\pm$ 5% (typical 2%, 1 ... 30 kV)
Discharge Tip:	Air (ball) and contact (point) as per IEC, exchangeable via threaded connection
Pulse detection:	Indicated by the "kV" symbol being displayed inverse, also acoustically in the "single" operating mode
Holding time:	> 5 s
Charge resistor:	> 50 M $\Omega$
Triggering:	Trigger button in handgrip or via remote control input
Instrument operation:	Via touch panel and microprocessor
Discharge modes:	Air-discharge / Contact-discharge
Polarity:	Positive, negative and automatic change
Operating modes:	Single / Repetitive / Random T (see section "Repetition") Pulse counter 0 ... 9999 Preselect counter 0 ... 9999 Continuous operation
Repetition:	0.5, 1, 5, 10, 20, 25 Hz (air) 0.5, 1, 5, 10, 20 Hz (contact) or in 1 Hz steps Random EUT discharge (bleed OFF mode) Free adjustable 0.04 to 300 s in 0.01 s steps
Discharge voltage:	Preprogrammed levels (IEC / EN and ISO standards)
Auto-shut-off:	After 15 minutes idle time (without loss of the test parameters)
Display:	Large LCD panel showing: Discharge voltage Breakdown voltage Polarity Air- / Contact-discharge Counter / preselect counter content Battery state monitor
Weight:	esd NX30: 14 kg (30 lbs) approx.
Dimensions	Base Station: (W)170mm x (D)360mm x (H)140mm Discharge Pistol: (W)85mm x (D)270mm x (H)260mm
Ambient conditions:	Operating +5° ... +40°C 20 ... 80% r.h. (non-condensing) 68 ... 106 kPa
Power supply:	Input: 100 – 250 V / 50 – 60 Hz / 1 A Output: DC 24 V / 2.3 A
Dimensions	Base Station: (W)170mm x (D)360mm x (H)140mm Discharge gun: (W)85mm x (D)270mm x (H)260mm

### EM TEST (Switzerland) GmbH

Sternenhofstrasse 15  
4153 Reinach BL1  
Switzerland

Phone : +41 61 717 91 91  
Fax : +41 61 717 91 99

URL : <http://www.emtest.com>

Copyright © 2018 EM TEST (Switzerland) GmbH

All right reserved.  
Specifications subject to change



**11 CE-certificate of compliance****DECLARATION OF CONFORMITY**

Manufacturer : **AMETEK Compliance Test Solutions GmbH**  
 Address : Sternenhofstr. 15  
 CH 4153 Reinach  
 Switzerland

declares, that under its sole responsibility, the product listed below, including all options, are conform with the applicable CE directives listed below, using the relevant section of the following EC standards and other normative documents.

Product name: esd NX30, esd NX30.1  
 Model Function Simulator for Electrostatic Discharge

**Low Voltage Directive 2014/35/EU**

Standard to which conformity is declared:

EN 61010-1 : 2011 Safety requirements for electrical equipment for measurement, control, and laboratory use.

**EMC Directive 2014/30/EU**

Standard(s) to which conformity is declared:

EN 61326-1 : 2012 Electrical equipment for measurement, control and laboratory use Class A  
 EN 61000-3-2 : 2014 Limits for harmonic current emissions  
 EN 61000-3-3 : 2013 Limitation of voltage changes, voltage fluctuations and flicker in public low-voltage supply systems.

European representative  
 AMETEK CTS Germany GmbH  
 Lünenerstr. 211  
 D 59174 Kamen  
 Tel: +49 (0) 2307 / 26070-0  
 Fax: +49 (0)2307 / 17050



Manufacturer  
 EM TEST (Switzerland) GmbH  
 Sternenhofstr. 15  
 CH 4153 Reinach  
 Tel: +41 61-7179191  
 Fax: +41 61-7179199



By A. Gerstner  
 General manager  
 Place Kamen, Germany  
 Date 20. December 2016

A. Burger  
 Design and Research  
 Reinach BL, Switzerland  
 1. Aug. 2016