



Insights and best practice

# EMC COMPLIANCE KNOW-HOW



TECHNICAL NOTE 0108

## BURST WAVEFORM VERIFICATION FOR TRANSIENT GENERATORS

### Overview

Electrical fast transients (EFT) or burst testing attempts to imitate the natural phenomenon of what occurs when a switch opens or closes a circuit. The repetitive fast transient test consists of a number of fast transients, coupled into power and control/signal ports of electrical and electronic equipment. The bursts in the test aim to imitate the high amplitude, short rise times, high repetition frequency, and low energy levels of typical transients in the field. Figure 1 shows a typical EFT burst when the contacts of a 230 V relay open.

The test is intended to demonstrate the immunity of electrical and electronic equipment when subjected to types of transient disturbances such as those originating from switching transients (interruption of inductive loads, relay contact bounce, etc.).





In typical compact immunity test systems such as the compact NX series or NSG 3000A series, available from AMETEK CTS, the signal can be delivered to an internal or external coupling-decoupling network (CDN). This paper will concentrate on verifying burst signals as described by IEC 61000-4-4 Edition 3.0 on single-phase devices on a table-top configuration using transient generators with internal coupling-decoupling networks (CDNs).

In order to perform burst testing, it is important to observe proper grounding and separation requirements due to the high voltage and high-frequency nature of the signals. Not only can improper grounding configuration cause damage to the transient generator or DUT; it is likely to present inaccurate burst characteristics to the DUT. Below are a generalized schematic of the proper test setup and a photo of a table-top implementation.

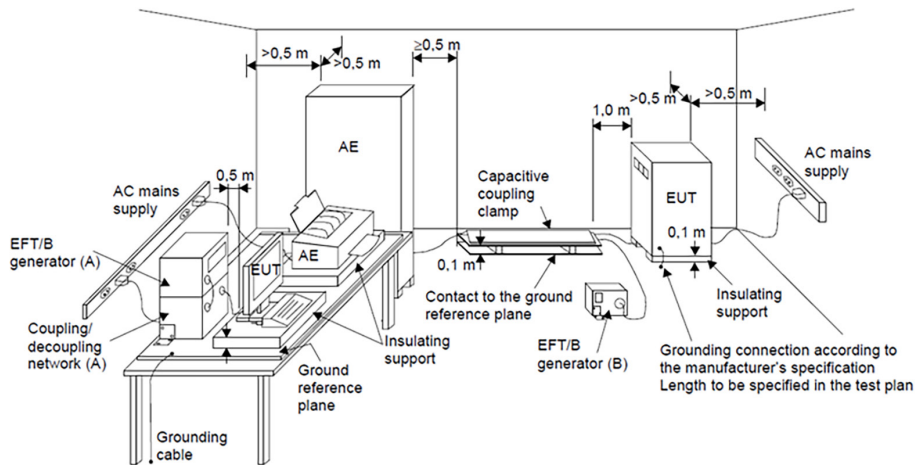

Figure 2

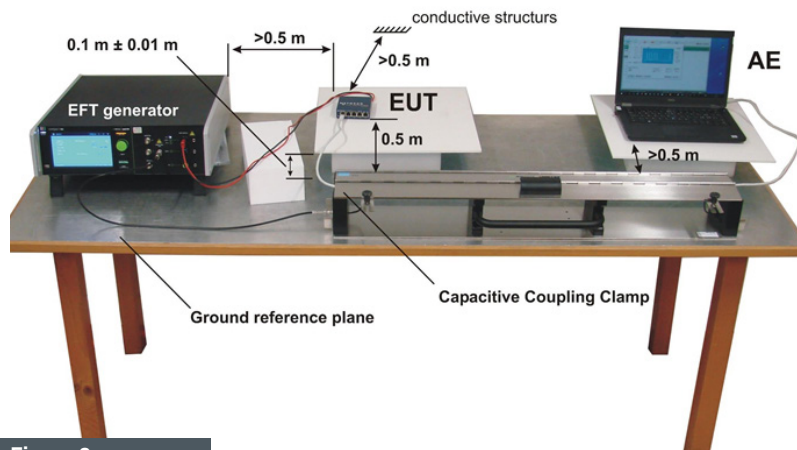

Figure 3



IEC 61000-4-4 defines four standard test levels along with custom levels that may be required for special testing requirements. [3]

**Table 1 - Test Levels**

Open circuit output test voltage and repetition frequency of the impulses				
Level	Power ports, earth port (PE)		Signal and control ports	
	Voltage peak kV	Repetition frequency kHz	Voltage peak kV	Repetition frequency kHz
1	0,5	5 or 100	0,25	5 or 100
2	1	5 or 100	0,5	5 or 100
3	2	5 or 100	1	5 or 100
4	4	5 or 100	2	5 or 100
X <sup>a</sup>	Special	Special	Special	Special

The use of 5 kHz repetition frequency is traditional, however, 100 kHz is closer to reality. Product committees should determine which frequencies are relevant for specific products or product types.

With some products, there may be no clear distinction between power ports and signal ports, in which case it is up to product committees to make this determination for test purposes.

<sup>a</sup> "X" can be any level, above, below or in between the others. The level shall be specified in the dedicated equipment specification.

Level 1: Well-protected environment (e.g., equipment in a computer room)

Level 2: Protected environment (e.g., equipment in a control room or terminal room of industrial and electrical plants)

Level 3: Typical industrial environment (e.g., equipment in an industrial process area)

Level 4: Severe industrial environment (e.g., equipment in an outdoor area of industrial processes and HV substations)

Once the test level(s) are determined from Table 1 above, verification must be done before testing begins. Here, verification of the transient generator's 50 Ω burst output for 50 Ω and 1,000 Ω loads; compact immunity test system's internal CDN used for power lines testing; and capacitive coupling clamps will be discussed. Table 2 describes the required burst characteristics for each test level.

**Table 2- Output Voltage Peak Values and Repetition Frequencies**

Set voltage kV	$V_p$ (open circuit) kV	$V_p$ (1 000 Ω) kV	$V_p$ (50 Ω) kV	Repetition frequency kHz
0,25	0,25	0,24	0,125	5 or 100
0,5	0,5	0,48	0,25	5 or 100
1	1	0,95	0,5	5 or 100
2	2	1,9	1	5 or 100
4	4	3,8	2	5 or 100

Measures should be taken to ensure that stray capacitance is kept to a minimum.



In each of the three cases described below, the pulses need to meet the following requirements regarding frequency tolerance, burst durations, burst period, rise time, and peak voltage.

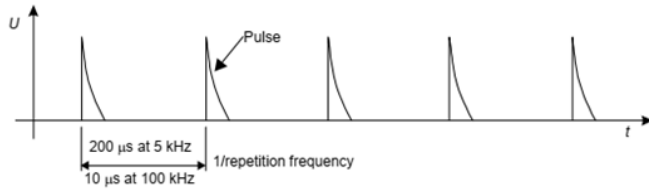

Figure 4

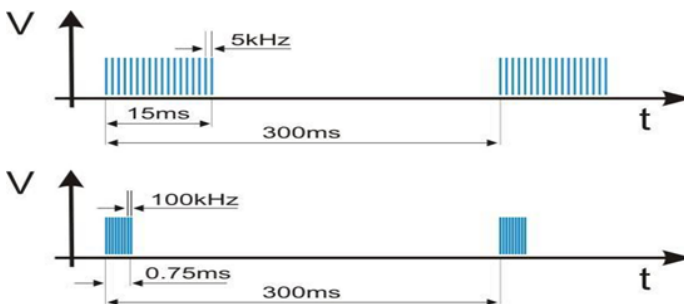

Figure 5

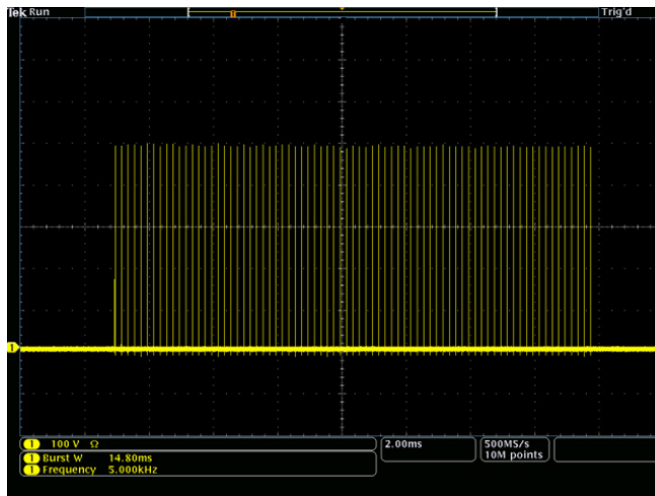

Figure 6

Table 3 - Test Levels

WAVEFORM CHARACTERISTIC	5 KHZ	100 KHZ
Frequency tolerance	± 20 %	
Burst duration	15 ± 3 ms.	0.75 ± 0.15 ms.
Burst period	300 ± 60 ms.	

Table 3 summarizes the characteristics of burst packets and Figures 4 and 5 show graphical representations of typical burst packets plotted in the time domain (voltage vs. time). Figure 6 shows an oscilloscope photograph of a burst packet at 5 kHz using a PVF 50 (50 Ω) resistor into a 50 Ω oscilloscope channel.

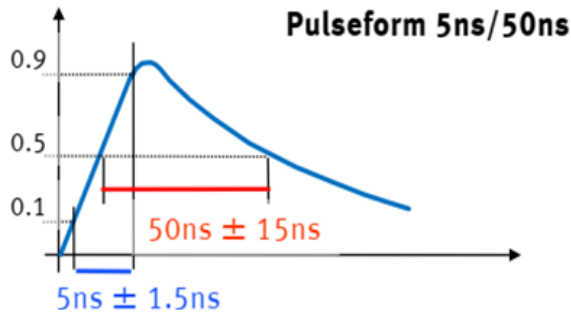

Figure 7

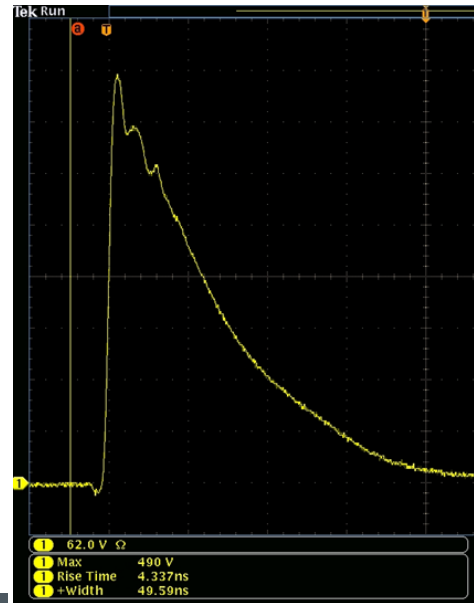

Figure 8

PULSE SHAPE	50 Ω	1000 Ω
Rise time (10% -90%)	5 ± 1.5 ns.	
Burst duration (50% to 50%)	50 ± 15 ns.	50 -15/+100 ns.
Peak Voltage	Vp of Table 2 ± 10%	Vp of Table 2 ± 20%

Table 4

Table 4 summarizes the characteristics of an individual burst at 5 kHz and Figure 7 shows a schematic view. Figure 8 shows an oscilloscope photograph of a burst pulse using a PVF 50 (50 Ω) into a 50 Ω oscilloscope channel.



Figure 9

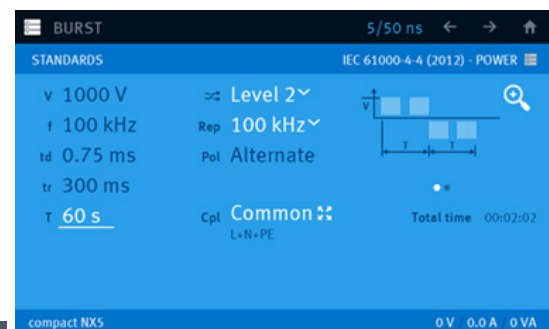

Figure 10



EFT/Burst testing can be done from the main Burst test menu of the Compact NX (Figure 10). All standard parameters can be changed from the screen. The parameters highlighted in white can be adjusted by the user (Table 5). [2,3]

T (test duration):	1 s to 999 s (standard minimum 60 s, or one cycle of the EUT process)
Level (voltage):	Level 1 (500 V) Level 2 (1000 V) Level 3 (2000 V) Level 4 (4000 V)
Rep (frequency):	5 kHz (td= 15 ms.) 100 kHz (td= 0.75 ms.)
Coupling ("Cpl"):	Common (L+N+PE) All (All combinations from L, N, PE) 50 Ohm (Coaxial output for capacitive coupling clamp)

**Table 5**

### Case 1: Calibration of 50 Ω Generator Output

Both the compact NX5 and NSG 3040A compact immunity test systems from AMETEK CTS have a 50 Ω burst output. Since in practice the EFT burst will be typically discharged into EUTs that are quite a bit different than a resistive 50 Ω load, verification of burst pulses into both 50 Ω and 1,000 Ω resistive loads should be done. To verify the burst signal to a 50 Ω load, a calibrated 50 Ω load like AMETEK CTS's PVF 50 (available separately or as part of the PVF BKIT 1 kit) should be configured as shown below. Likewise, to verify the burst signal to a 1,000 Ω load, a calibrated 1,000 Ω load like AMETEK CTS's PVF 1000 (also available separately or as part of the PVF BKIT 1 kit) should be configured as shown below. A scope with a bandwidth of at least 400 MHz is required.

*Verifying with a 50 Ω load:*

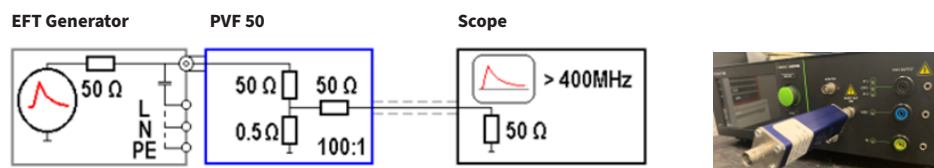

**Figure 11**

**Ratio with PVF 50** is 1:400. In this example, a 2,000 V burst would display 5 V on a scope.

*Verifying with a 1000 Ω load:*

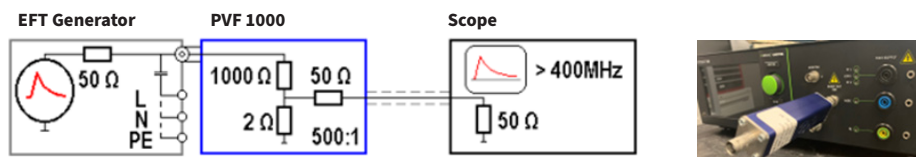

**Figure 12**

**Ratio with PVF 1000** is 1:1,000. In this example, a 2,000 V burst would display 2 V on a scope.



### Case 2: Calibration of Internal CDN Outputs for Mains Supply

- The EFT transients are coupled to all CDN lines simultaneously (i.e. common mode coupling).
- The output of the CDN shall not be short circuited.
- The EFT transients shall be measured at each individual output of the CDN with a 50Ω load (PVF 50), while the other outputs are open. The PVF AD 1 adapter is also included in the PVF BKIT 1 kit.
- Each individual output must show the transients within the tolerances as specified.

#### Line, Neutral, PE | Ground References

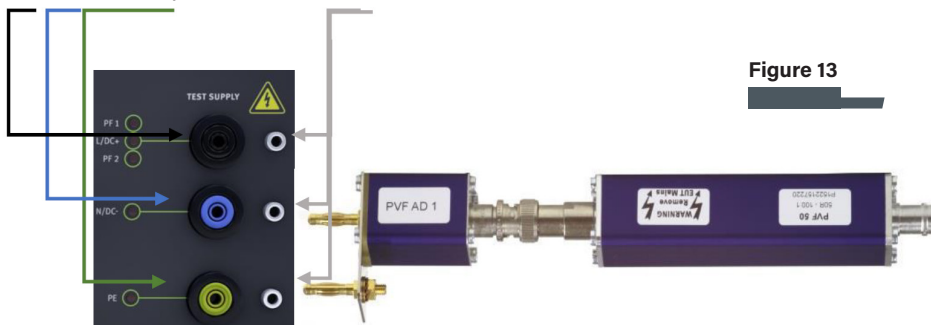

Figure 13

Ratio with PVF 50 is 400:1. In this example, a 4,000 V burst would display 10 V on scope.

### Case 3: Calibration of Capacitive Coupling Clamp

Edition 3 describes the calibration method of the capacitive coupling clamp with a transducer plate. The setup shown below includes the coupling clamp (CCI), along with its pulse verification kit (CCI PVKIT 1) which includes a transducer plate, a MC to SHV adapter (PVF AD 3), and a support piece.

The transducer plate is to be inserted into the coupling clamp and must be terminated at the opposite end of the generator connection with a coaxial load of 50 Ω and measured with an oscilloscope. Shown below is a schematic and photographic depiction of the setup to verify EFT pulse to a capacitive coupling clamp.

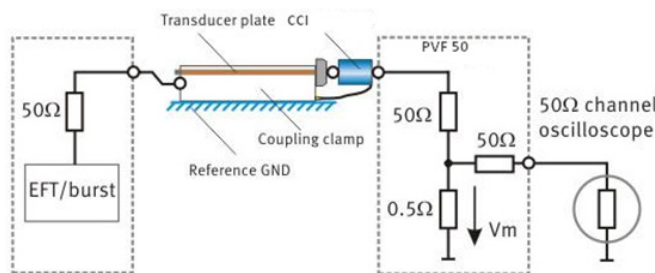

Figure 14 - Example of a calibration setup of the capacitive coupling clamp

Ratio with PVF 50 is 1:400. In this example, a 2,000 V burst would display 5 V on a scope. [3]

The calibration is performed with the generator output voltage set to 2 kV. The calibration needs to meet the following requirements:

- Rise time  $t_r$  5ns ± 1.5 ns*
- Pulse duration  $t_d$  50 ns ± 15ns*
- Peak value of voltage 1 kV ± 200 V*



## References

[1] Markus Fuhrer, "Interactive Guide for the Industry NX Series Products", AMETEK CTS Training Series, (2019)

[2] AMETEK CTS, "Manual for iec.control Software (Version  $\geq$  7.1.0)", (2017)

[3] AMETEK CTS, "Manual for Operation Compact NX5/NX7 – The Ultra-Compact Simulator and Its System Modules", Ametek CTS Training Series", (2019)

## About AMETEK CTS

AMETEK CTS is a global leader in EMC compliance testing and RF power amplifiers. AMETEK has been designing and manufacturing precision instruments for more than 30 years. Under the brand names of EM Test, Teseq, IFI and Milmega the company produce a wide range of specialist solutions aligned to the individual needs of equipment manufacturers across a variety of industries. These include:

- Automotive
- Aerospace and Defense
- Consumer electronics
- Household appliances
- Medical devices
- Renewable energy

From its design and manufacturing facilities in Switzerland, Germany, the United States and the UK, AMETEK CTS provides customers with innovative solutions to the complex requirements of EMC compliance standards.